

STRUCTURE & TÂCHES DE L'ASSOCIATION

15 COMMUNES → 30'000  → 32'000  EH

71 KM COLLECTEURS 1'500 CHAMBRES



17 STREL / STAP  

12 DEVERSOIRS ORAGE

1 STEP 45'000  (56'000  EH)

« BOUES ACTIVEES »

 → 

 → $\left. \begin{array}{l} \leq 2008 \\ > 2008 \end{array} \right\}$  



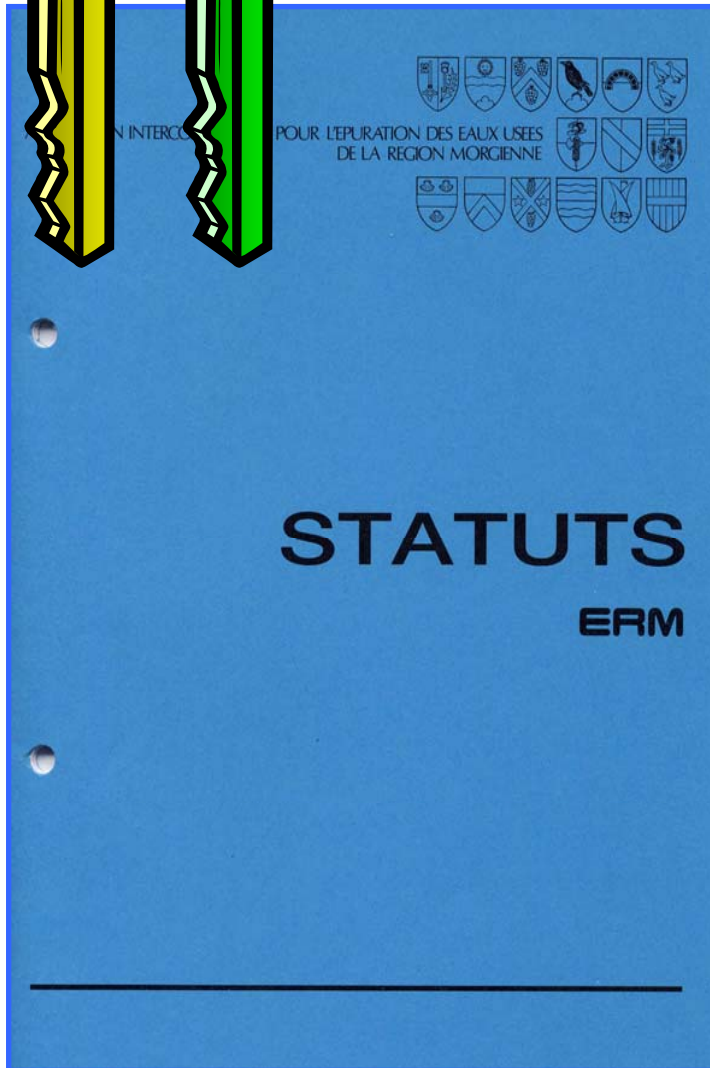
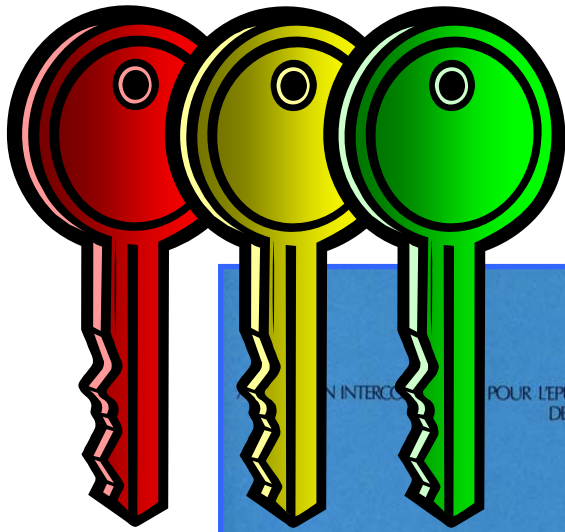

CHF 2'923'000

BUDGET 2007

ASPECT FINANCIER – CLE DE REPARTITION

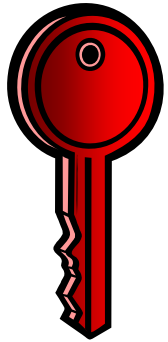

EXPLOITATION 79 % Σ

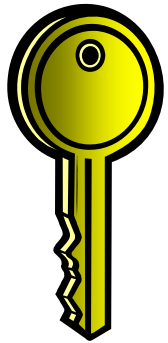
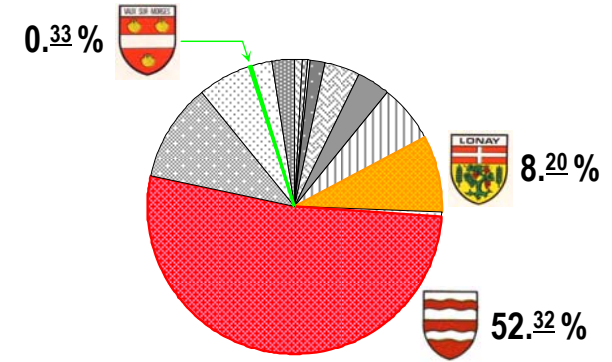

RESEAU 14 % Σ

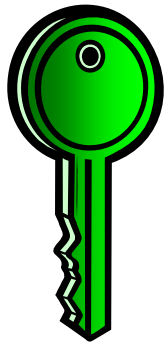
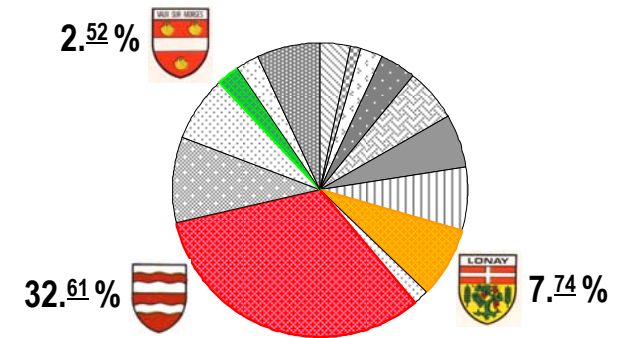

STREL 7 % Σ

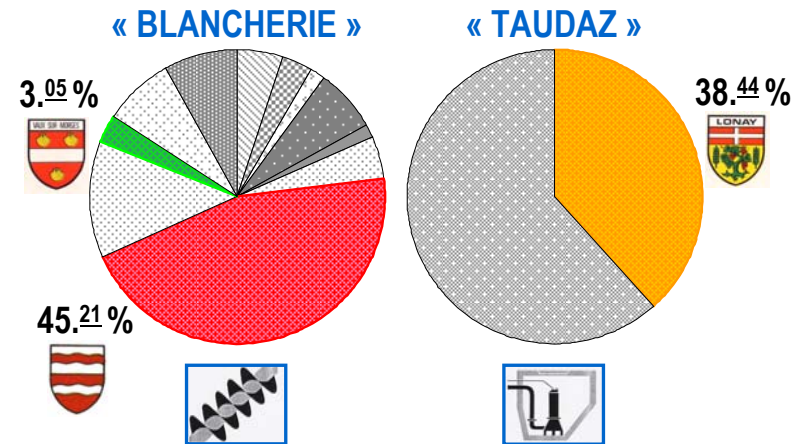

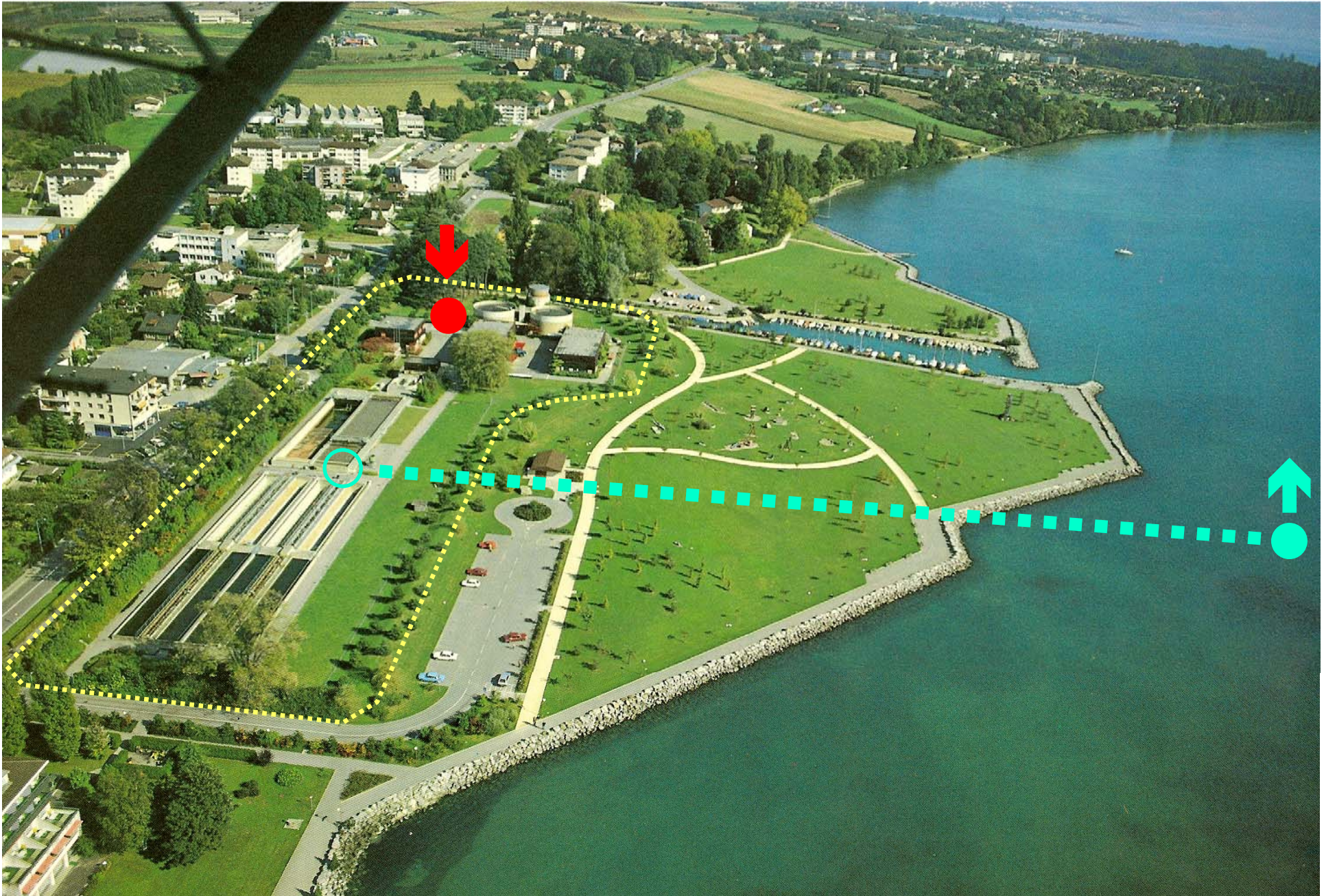

EPURATION – FONCTIONNEMENT STEP

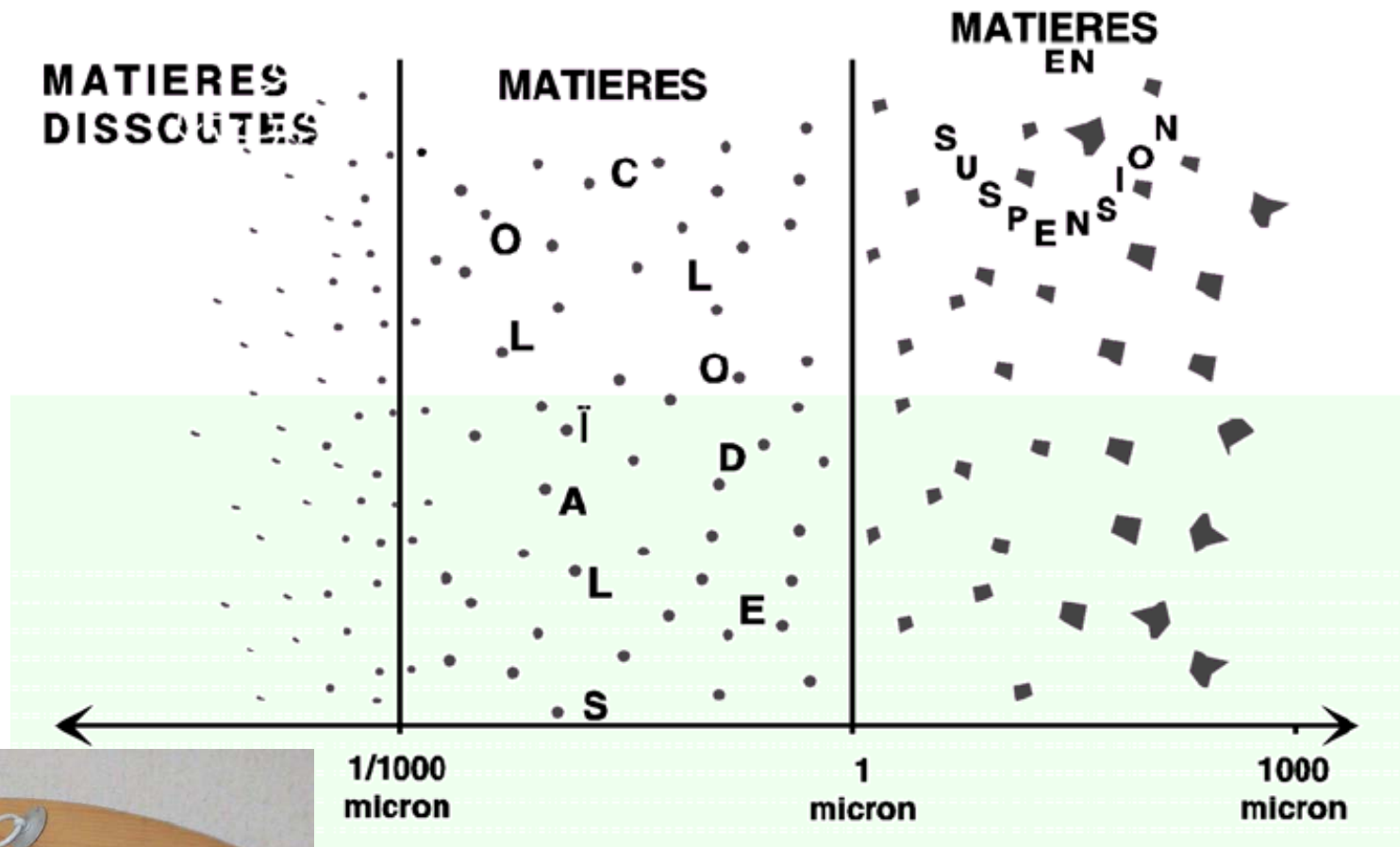

EPURATION – FONCTIONNEMENT STEP

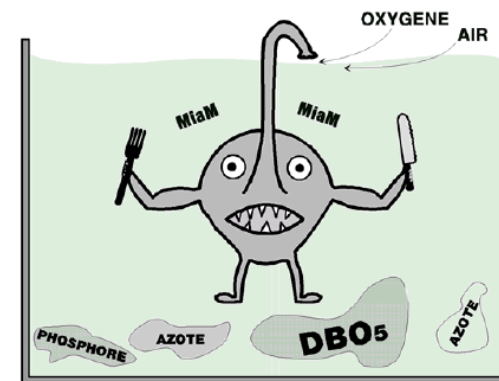
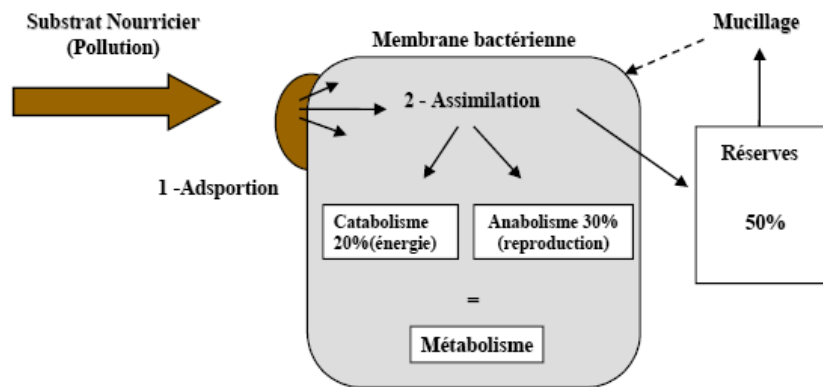
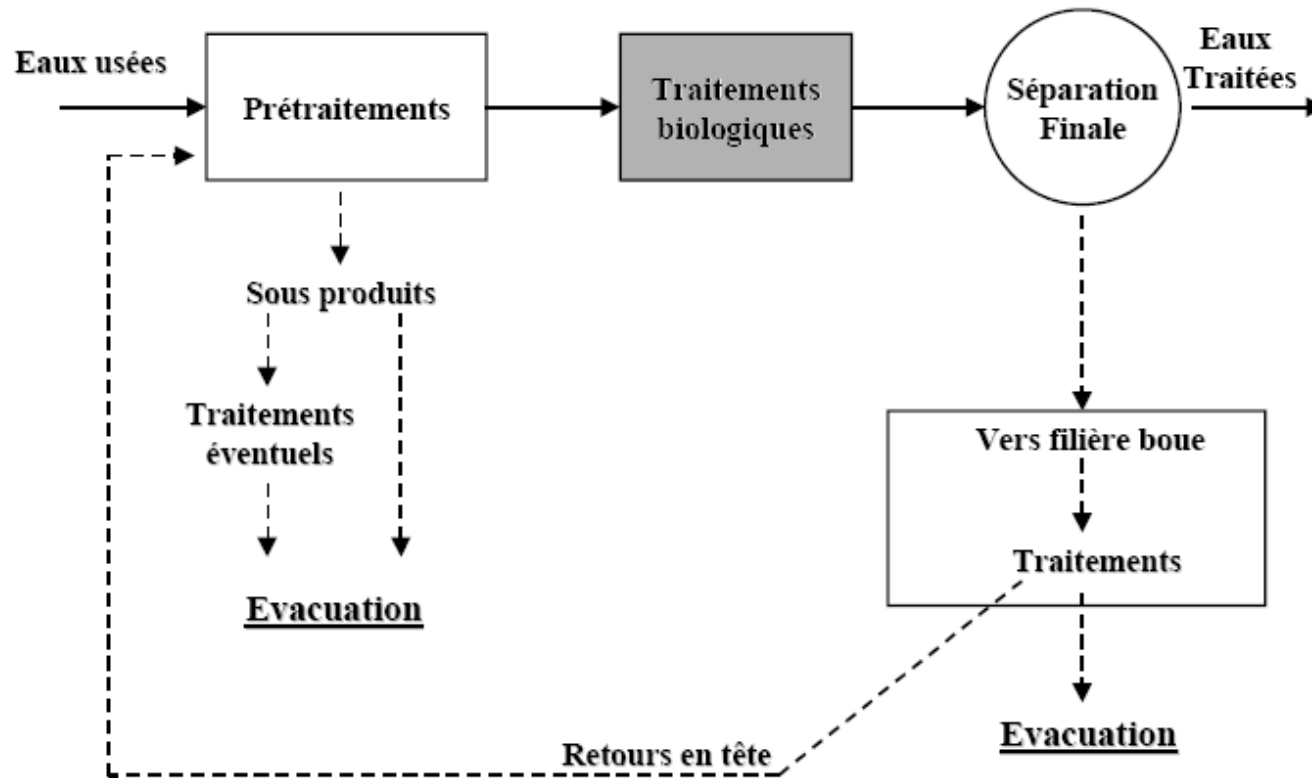

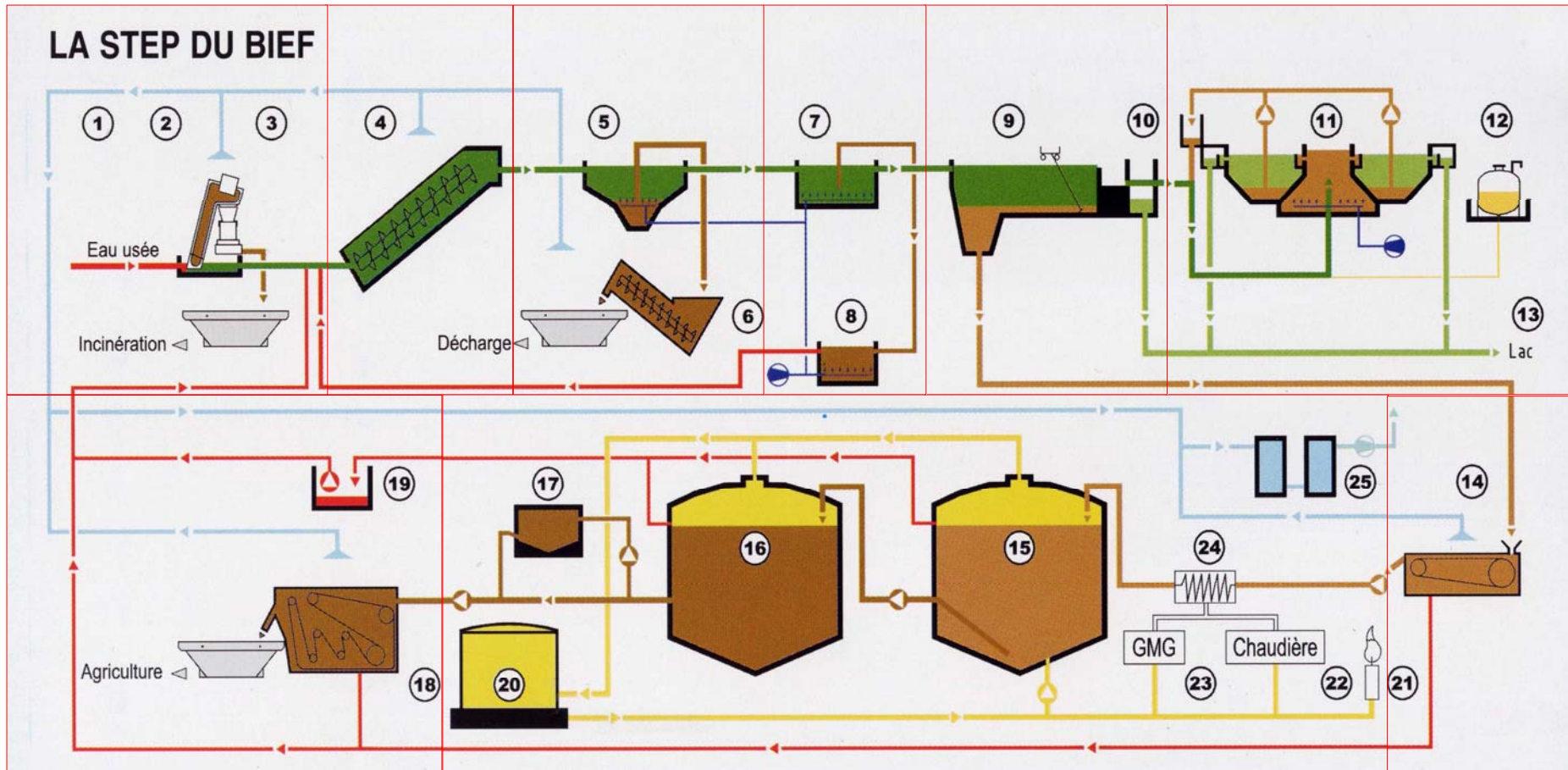

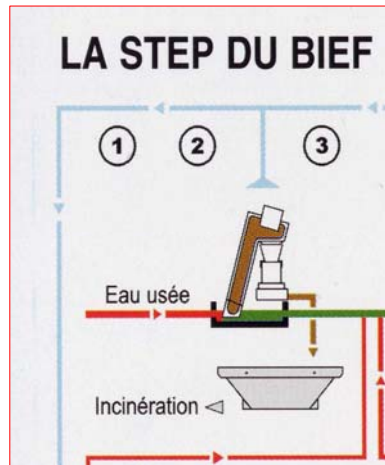

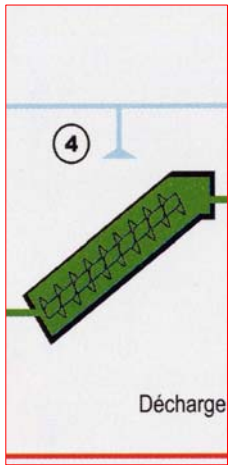

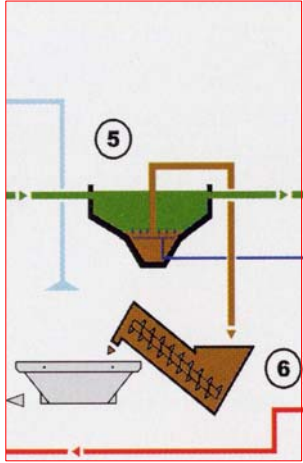

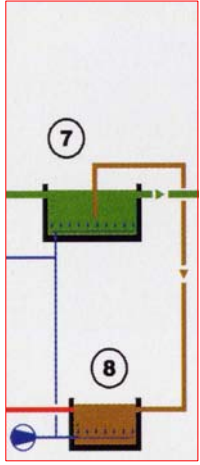

EPURATION – FONCTIONNEMENT STEP

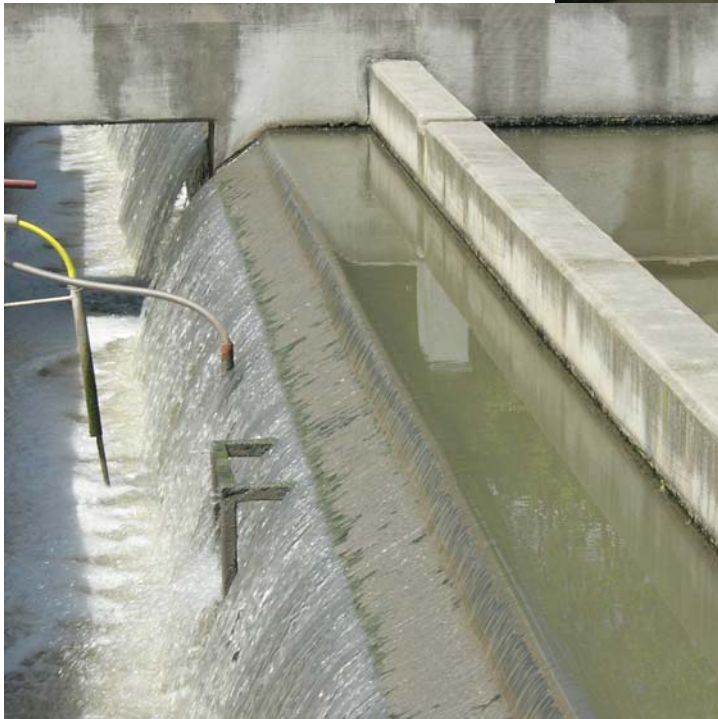
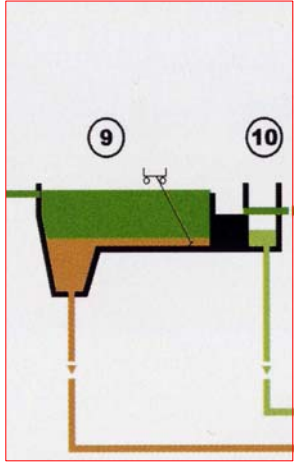

EPURATION – FONCTIONNEMENT STEP

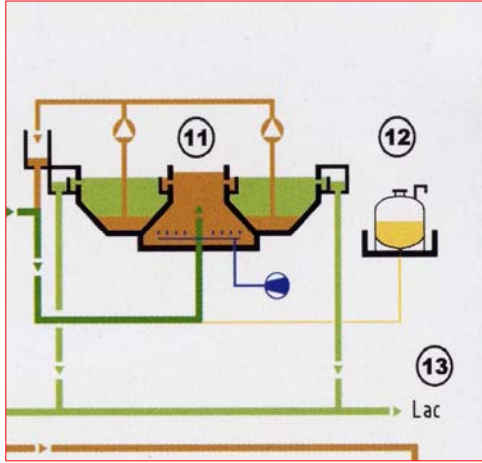

EPURATION – FONCTIONNEMENT STEP

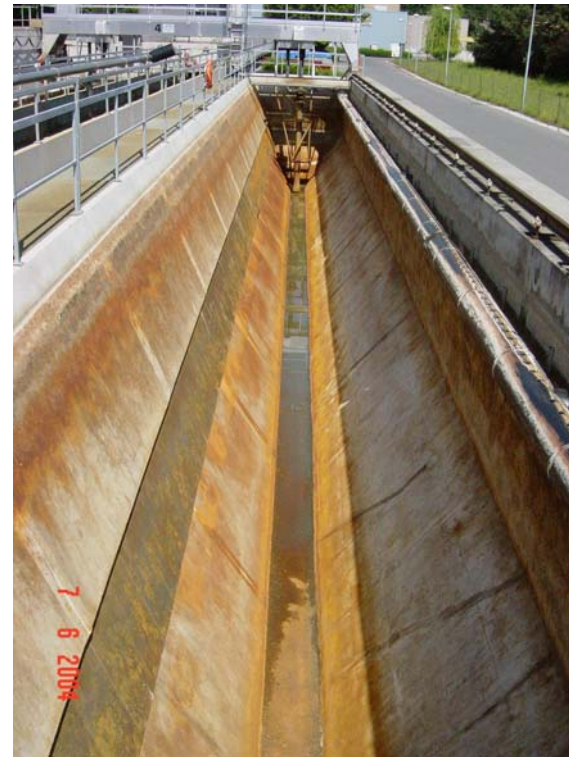
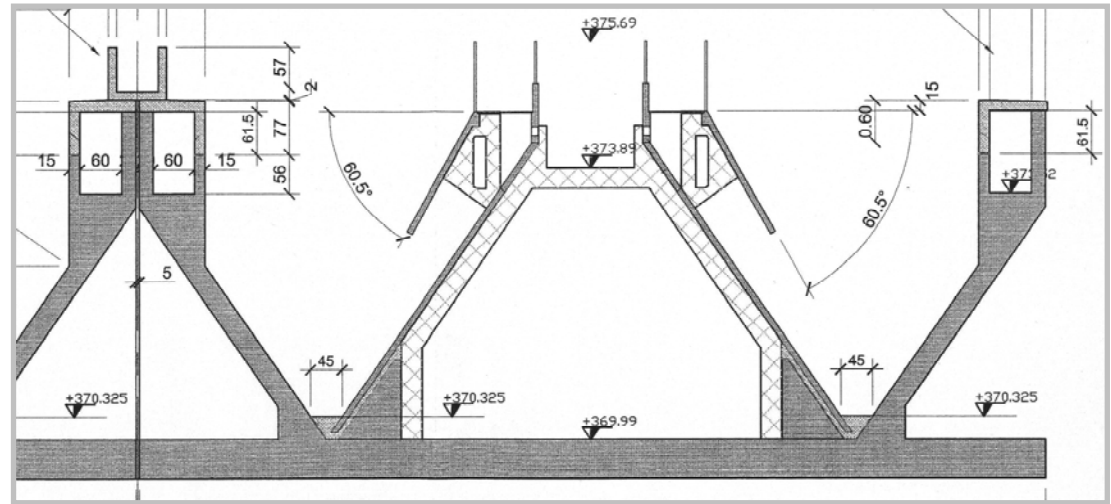
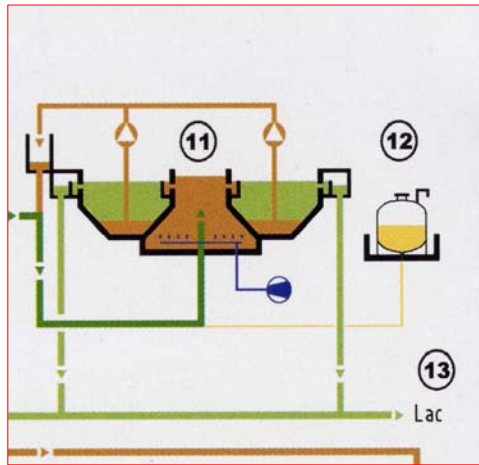

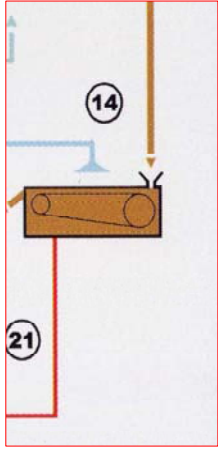

EPURATION – FONCTIONNEMENT STEP

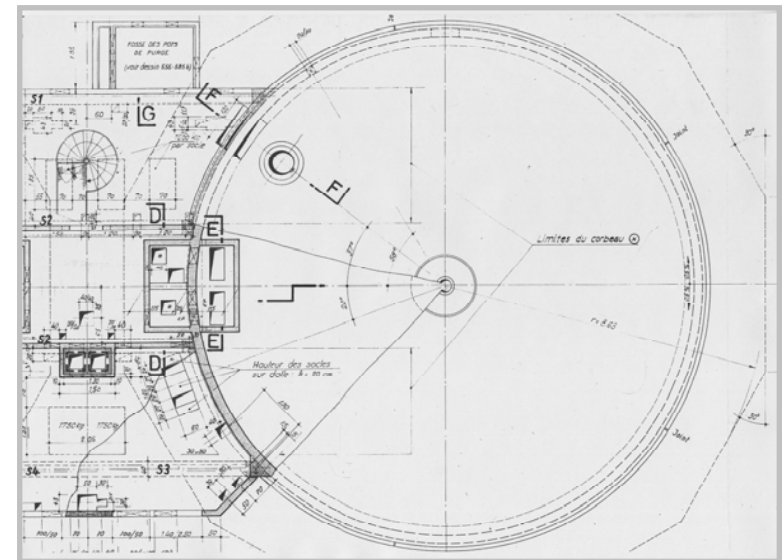
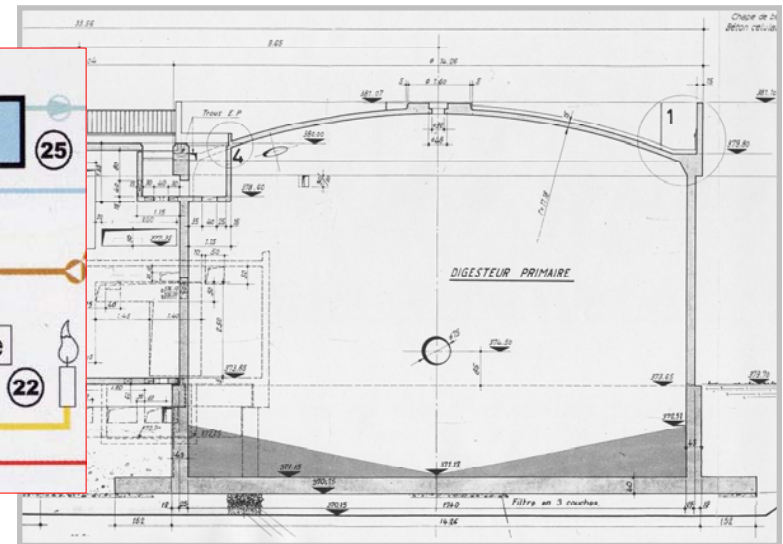
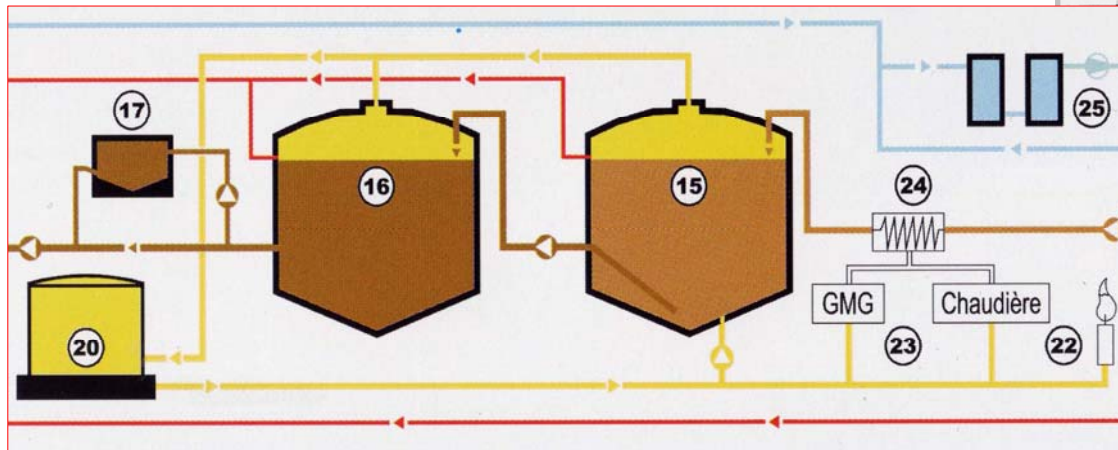

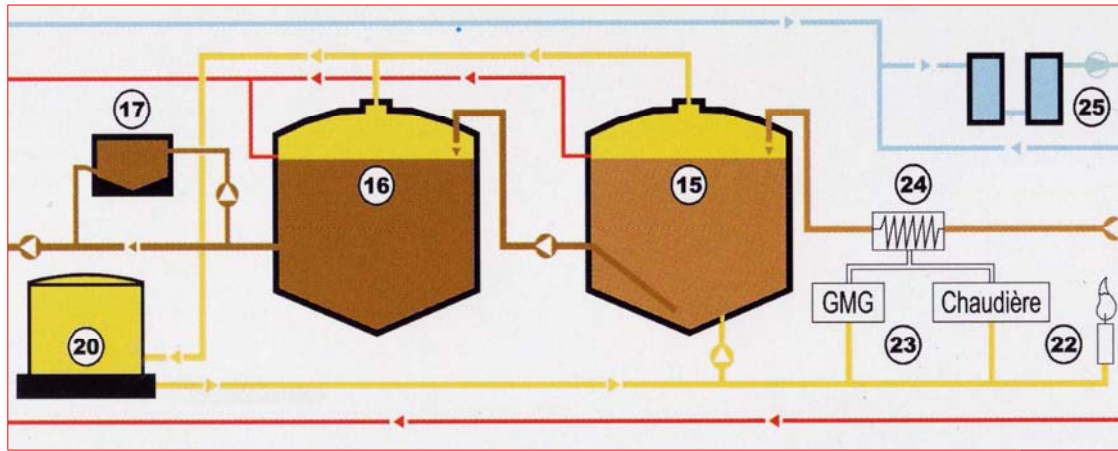

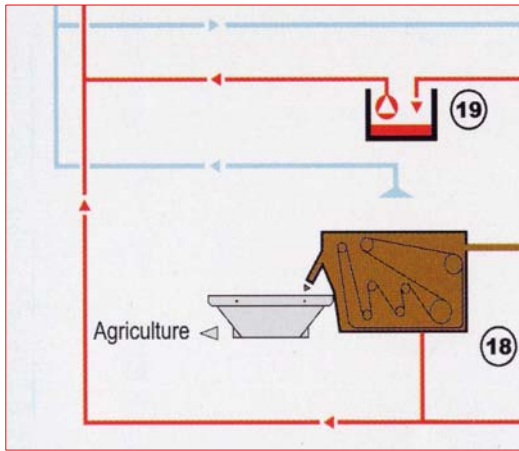

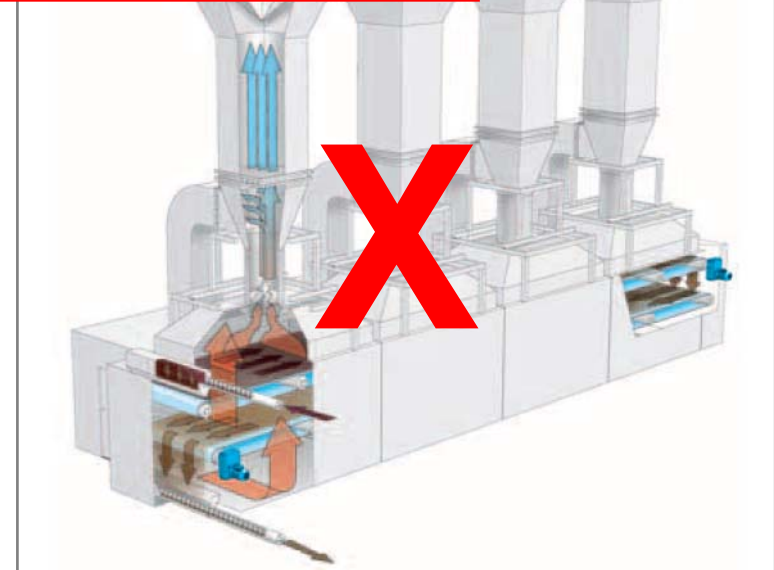
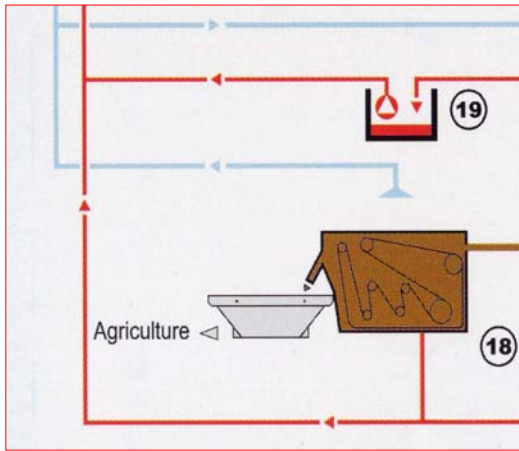

EPURATION – FONCTIONNEMENT STEP

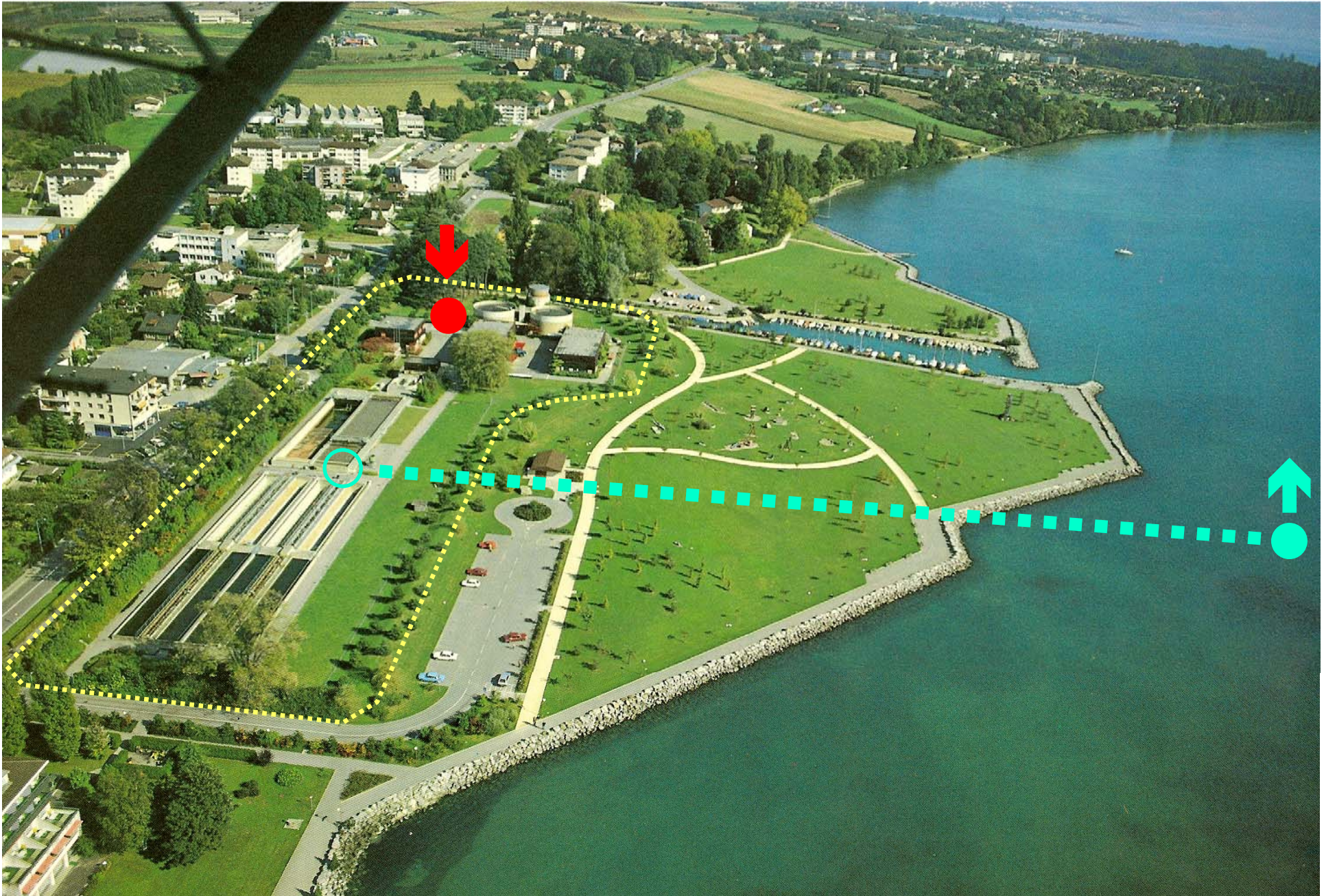

EPURATION – FONCTIONNEMENT STEP