

Chapter 1

The Euclidean space \mathbb{R}^n

The set \mathbb{R}^n is defined as the set of all ordered n -tuples (x_1, \dots, x_n) of real numbers. These n -tuples are called points of \mathbb{R}^n . We can also see \mathbb{R}^n as a vector space of dimension n . In this chapter we will first talk about the algebraic structure of \mathbb{R}^n . Next we will introduce a topological structure that shall allow us to extend the concept of limits to \mathbb{R}^n . We can find these basic structures in more abstract spaces such as normed spaces or metric spaces which we will briefly introduce.

1.1 The vector space \mathbb{R}^n

Notation. We can represent elements of the vector space \mathbb{R}^n as column vectors with n entries instead of ordered n -tuples. We write:

$$\mathbf{x} = \begin{pmatrix} x_1 \\ \cdot \\ \cdot \\ \cdot \\ x_n \end{pmatrix}$$

Or \mathbf{x} with an arrow above $\mathbf{x} = \vec{x}$. There is a unique column vector corresponding to an n -tuple and vice versa. We will generally use column vectors to denote elements of \mathbb{R}^n in calculations. For the text to be clear we will use the two other notations for the parameters of functions defined on \mathbb{R}^n .

Vector space. The set \mathbb{R}^n can be considered as a vector space equipped with addition:

$$\mathbf{x} + \mathbf{y} = \begin{pmatrix} x_1 \\ \cdot \\ \cdot \\ \cdot \\ x_n \end{pmatrix} + \begin{pmatrix} y_1 \\ \cdot \\ \cdot \\ \cdot \\ y_n \end{pmatrix} = \begin{pmatrix} x_1 + y_1 \\ \cdot \\ \cdot \\ \cdot \\ x_n + y_n \end{pmatrix}$$

and the multiplication by a scalar $\lambda \in \mathbb{R}$ defined as

$$\lambda \mathbf{x} = \lambda \begin{pmatrix} x_1 \\ \cdot \\ \cdot \\ \cdot \\ x_n \end{pmatrix} = \begin{pmatrix} \lambda x_1 \\ \cdot \\ \cdot \\ \cdot \\ \lambda x_n \end{pmatrix}$$

Scalar product. The vector space \mathbb{R}^n is also equipped with a scalar product $\langle \cdot, \cdot \rangle : \mathbb{R}^n \times \mathbb{R}^n \rightarrow \mathbb{R}$ defined as

$$\langle \mathbf{x}, \mathbf{y} \rangle = \sum_{k=1}^n x_k y_k.$$

A scalar product satisfies the three following properties:

1. Positive-definiteness: $\langle \mathbf{x}, \mathbf{x} \rangle \geq 0$ for all \mathbf{x} and $\langle \mathbf{x}, \mathbf{x} \rangle = 0 \Leftrightarrow \mathbf{x} = \mathbf{0}$
2. Symmetry: $\langle \mathbf{x}, \mathbf{y} \rangle = \langle \mathbf{y}, \mathbf{x} \rangle$
3. Linear in each argument: $\langle \alpha \mathbf{x} + \beta \mathbf{y}, \mathbf{z} \rangle = \alpha \langle \mathbf{x}, \mathbf{z} \rangle + \beta \langle \mathbf{y}, \mathbf{z} \rangle$ for all $\mathbf{x}, \mathbf{y}, \mathbf{z} \in \mathbb{R}^n$ and $\alpha, \beta \in \mathbb{R}$

In linear algebra a vector \mathbf{x} is also an $n \times 1$ matrix. Its transpose, written $\mathbf{x}^T = (x_1, \dots, x_n)$, is therefore a $1 \times n$ matrix, and we can interpret the scalar product of two vectors \mathbf{x}, \mathbf{y} as the matrix product of \mathbf{x}^T and \mathbf{y} :

$$\langle \mathbf{x}, \mathbf{y} \rangle = \mathbf{x}^T \mathbf{y} = (x_1, \dots, x_n) \cdot \begin{pmatrix} y_1 \\ \cdot \\ \cdot \\ \cdot \\ y_n \end{pmatrix}.$$

Dimension of \mathbb{R}^n . The vectors

$$\mathbf{e}_1 = \begin{pmatrix} 1 \\ 0 \\ \cdot \\ \cdot \\ 0 \end{pmatrix}, \dots, \mathbf{e}_k = \begin{pmatrix} 0 \\ \cdot \\ 1 \\ \cdot \\ 0 \end{pmatrix}, \dots, \mathbf{e}_n = \begin{pmatrix} 0 \\ \cdot \\ \cdot \\ 0 \\ 1 \end{pmatrix}$$

form an orthonormal basis for \mathbb{R}^n and

$$\mathbf{x} = \sum_{k=1}^n x_k \mathbf{e}_k$$

for all $\mathbf{x} \in \mathbb{R}^n$ with $x_k = \langle \mathbf{x}, \mathbf{e}_k \rangle \in \mathbb{R}$. Thus,

$$\dim \mathbb{R}^n = n < \infty.$$

We say that \mathbb{R}^n is a Euclidean vector space of dimension n . Every real vector space of dimension n can be identified to \mathbb{R}^n .

OTHER VECTOR SPACES

Euclidean spaces of infinite dimension. The set $l_2(\mathbb{R})$ is the set of numerical sequences $(x_k)_{k \in \mathbb{N}}$ such that $\sum_{k=0}^{\infty} x_k^2 < \infty$. It is a vector space equipped with the addition $(x_k)_{k \in \mathbb{N}} + (y_k)_{k \in \mathbb{N}} = (x_k + y_k)_{k \in \mathbb{N}}$. We define a scalar product by

$$\langle (x_k)_{k \in \mathbb{N}}, (y_k)_{k \in \mathbb{N}} \rangle = \sum_{k=0}^{\infty} x_k y_k.$$

It is easier to represent the sequences as vectors in " \mathbb{R}^∞ ". We can write

$$\langle \mathbf{x}, \mathbf{y} \rangle = \sum_{k=0}^{\infty} x_k y_k.$$

The set $C([a, b])$ of continuous functions $f : [a, b] \rightarrow \mathbb{R}$ is a vector space and we can define a scalar product on $C([a, b])$ as

$$\langle f, g \rangle = \int_a^b f(x)g(x) dx.$$

The complex vector space \mathbb{C}^n . The space \mathbb{C}^n is the set of all complex vectors \mathbf{x} equipped with the usual addition and the scalar multiplication by complex numbers. It is a complex vector space (this means it is a vector space over the field \mathbb{C}). We can define a scalar product by

$$\langle \mathbf{x}, \mathbf{y} \rangle = \sum_{k=1}^n \bar{x}_k y_k. \quad (1.1)$$

In particular, this scalar product is linear in its second argument and anti-linear in the first argument. In addition, for all $\mathbf{x}, \mathbf{y} \in \mathbb{C}^n$

$$\langle \mathbf{x}, \mathbf{y} \rangle = \overline{\langle \mathbf{y}, \mathbf{x} \rangle}.$$

The vectors \mathbf{e}_k , $k = 1 \dots n$, form an orthonormal basis. We say that the space \mathbb{C}^n is a Hermitian space of dimension n . In quantum mechanics the spin state of a particle of spin s is represented by a vector in \mathbb{C}^{2s+1} .

The real vector space \mathbb{C}^n . A Hermitian space is always a Euclidean space if multiplication is restricted to real numbers. We take the scalar product

$$\langle \mathbf{x}, \mathbf{y} \rangle_{\mathbb{R}} = \text{Re}(\langle \mathbf{x}, \mathbf{y} \rangle) = \text{Re}\left(\sum_{k=1}^n \bar{x}_k y_k\right). \quad (1.2)$$

The vectors $\mathbf{e}_k, i\mathbf{e}_k$, $k = 1 \dots n$, form an orthonormal basis in relation to this scalar product. Consequently, the real vector space \mathbb{C}^n is of dimension $2n$. Therefore we can identify \mathbb{C}^n with the Euclidean space \mathbb{R}^{2n} .

1.2 The normed space \mathbb{R}^n

To be able to extend the analytical methods presented in Analysis I to the space \mathbb{R}^n , it has to be provided with a topological structure. On the field \mathbb{R} we used the absolute value to define a distance $d(x, y) = |x - y|$. We have defined the convergence and the continuity in \mathbb{R} with this distance d . We seek to generalize the absolute value and the distance to the space \mathbb{R}^n . To do that we will introduce the concepts of norm and a metric.

Definition - norm and normed space. Let E be a real vector space. A function $\|\cdot\| : E \rightarrow \mathbb{R}_+$ is called a norm on E if $\|\cdot\|$ verifies the three following properties:

1. Positive-definiteness: $\|\mathbf{x}\| \geq 0$ for all $\mathbf{x} \in E$ and $\|\mathbf{x}\| = 0 \Leftrightarrow \mathbf{x} = \mathbf{0}$
2. Homogeneity: $\|\lambda \cdot \mathbf{x}\| = |\lambda| \cdot \|\mathbf{x}\|$ for all $\lambda \in \mathbb{R}$ and $\mathbf{x} \in E$
3. Triangle inequality: $\|\mathbf{x} + \mathbf{y}\| \leq \|\mathbf{x}\| + \|\mathbf{y}\|$ for all $\mathbf{x}, \mathbf{y} \in E$

The couple $(E, \|\cdot\|)$ is called a normed space.

The Euclidean norm on \mathbb{R}^n . The function $\|\cdot\|_2 : \mathbb{R}^n \rightarrow \mathbb{R}$ defined by

$$\|\mathbf{x}\|_2 = \sqrt{\langle \mathbf{x}, \mathbf{x} \rangle} = \left(\sum_{k=1}^n x_k^2 \right)^{\frac{1}{2}} \quad (1.3)$$

is a norm on \mathbb{R}^n . We call it the Euclidean norm on \mathbb{R}^n . The triangle inequality is a consequence of the Cauchy-Schwarz inequality

$$\langle \mathbf{x}, \mathbf{y} \rangle^2 \leq \langle \mathbf{x}, \mathbf{x} \rangle \langle \mathbf{y}, \mathbf{y} \rangle = \|\mathbf{x}\|^2 \|\mathbf{y}\|^2. \quad (1.4)$$

It follows that \mathbb{R}^n equipped with the Euclidean norm is a normed space.

Proposition. $(\mathbb{R}^n, \|\cdot\|_2)$ is a normed space.

Euclidean distance on \mathbb{R}^n . In a normed space $(E, \|\cdot\|)$ we can introduce the distance between two vectors by

$$d(\mathbf{x}, \mathbf{y}) := \|\mathbf{x} - \mathbf{y}\|. \quad (1.5)$$

It verifies the three following properties:

1. Positive-definiteness: $d(\mathbf{x}, \mathbf{y}) \geq 0$ for all $\mathbf{x}, \mathbf{y} \in M$ and $d(\mathbf{x}, \mathbf{y}) = 0 \Leftrightarrow \mathbf{x} = \mathbf{y}$
2. Symmetry: $d(\mathbf{x}, \mathbf{y}) = d(\mathbf{y}, \mathbf{x})$
3. Triangle inequality: $d(\mathbf{x}, \mathbf{y}) \leq d(\mathbf{x}, \mathbf{z}) + d(\mathbf{z}, \mathbf{y})$

for $\mathbf{x}, \mathbf{y}, \mathbf{z} \in E$. The couple (E, d) is called a metric space. In \mathbb{R}^n we measure the distance between two vectors with the Euclidean distance (or metric) given by

$$d(\mathbf{x}, \mathbf{y}) = d_2(\mathbf{x}, \mathbf{y}) = \|\mathbf{x} - \mathbf{y}\|_2 = \sqrt{(x_1 - y_1)^2 + \dots + (x_n - y_n)^2}. \quad (1.6)$$

Geometric Interpretation. In \mathbb{R}^2 or \mathbb{R}^3 the Euclidean metric $d_2(\mathbf{x}, \mathbf{y}) = \|\mathbf{x} - \mathbf{y}\|_2$ corresponds to the Euclidean (usual) distance between two points \mathbf{x} and \mathbf{y} . The Euclidean norm $\|\mathbf{x}\|_2$ also corresponds to the length of a vector \mathbf{x} . The scalar product $\langle \mathbf{x}, \mathbf{y} \rangle$ measures the angle between the two vectors \mathbf{x} and \mathbf{y} : if we designate $\theta = \angle(\mathbf{x}, \mathbf{y})$, then

$$\langle \mathbf{x}, \mathbf{y} \rangle = \|\mathbf{x}\|_2 \|\mathbf{y}\|_2 \cos \theta.$$

In particular if \mathbf{x} and \mathbf{y} are orthogonal vectors, i.e. $\theta = \pm\pi/2$, then $\langle \mathbf{x}, \mathbf{y} \rangle = 0$.

1.3 Subspaces of \mathbb{R}^n

To define certain notions and properties of subsets of \mathbb{R}^n we only use the fact that the space \mathbb{R}^n has a metric, for example the Euclidean distance $d(\mathbf{x}, \mathbf{a}) = d_2(\mathbf{x}, \mathbf{a})$. We will later see that for the vector space \mathbb{R}^n this does not depend on the choice of d if d is defined from another norm on \mathbb{R}^n .

Open ball. Let $\mathbf{a} \in \mathbb{R}^n$ and $r > 0$. The set

$$B(\mathbf{a}, r) = \{\mathbf{x} \in \mathbb{R}^n : d(\mathbf{x}, \mathbf{a}) < r\}$$

is called the open ball with centre \mathbf{a} and radius r . The topological characterizations of real subsets introduced in Analysis I extend themselves naturally to the space \mathbb{R}^n :

Open subset. A subset $S \subset \mathbb{R}^n$ is open if for all $x \in S$ there exists a neighborhood $B(\mathbf{x}, \epsilon)$ with $\epsilon > 0$ such that $B(\mathbf{x}, \epsilon) \subset S$. The empty set \emptyset and the space \mathbb{R}^n are open. Any open ball $B(\mathbf{a}, r)$ is an open space. Any union of open sets is open. Any finite intersection of open sets is open.

Closed subset. A subset $S \subset \mathbb{R}^n$ is closed if $\mathbb{R}^n \setminus S$ is open. The empty set \emptyset and the space \mathbb{R}^n are closed (and open).

The interior and the boundary of a set. Let $S \subset \mathbb{R}^n$ and $a \in S$. We say a is in the interior of S if there exists a neighborhood $B(\mathbf{a}, \epsilon)$ with $\epsilon > 0$ such that $B(\mathbf{a}, \epsilon) \subset S$. The set of all interior points of S is called the interior of S and written $\overset{\circ}{S}$. A point $a \in \mathbb{R}^n$ is called a boundary point of S if any neighborhood $B(\mathbf{a}, \epsilon)$ contains points of S and points of $\mathbb{R}^n \setminus S$. The set of all boundary points of S is called the boundary of S and written ∂S .

Example. The unit ball is open in \mathbb{R}^n (in regards to the norm $\|\cdot\|_2$) and is defined by

$$B_1 = B(\mathbf{0}, 1) = \{\mathbf{x} \in \mathbb{R}^n : \|\mathbf{x}\| < 1\}.$$

Its boundary is the sphere

$$\partial B_1 = \{\mathbf{x} \in \mathbb{R}^n : \|\mathbf{x}\| = 1\}.$$

The closure of a set. Let $S \subset \mathbb{R}^n$ and $a \in \mathbb{R}^n$. We say a is a point of closure of S if for any neighborhood $B(\mathbf{a}, \epsilon)$:

$$B(\mathbf{a}, \epsilon) \cap S \neq \emptyset.$$

The set of all points of closure of S is called the closure of S and written \bar{S} .

Proposition. Let $S \subset \mathbb{R}^n$. Then

1. $\overset{\circ}{S} \subset S \subset \bar{S}$.
2. $\bar{S} = \overset{\circ}{S} \cup \partial S$.
3. S is open if and only if $S = \overset{\circ}{S}$.
4. S is closed if and only if $S = \bar{S}$.

Examples.

1. Let $f : \mathbb{R} \rightarrow \mathbb{R}$ be a continuous function. The graph $G_f = \{(x, f(x)) \in \mathbb{R}^2 : x \in \mathbb{R}\}$ represents a curve in \mathbb{R}^2 . We have $\overset{\circ}{G}_f = \emptyset$. Therefore $G_f = \partial G_f$. The graph of a continuous function is a closed set in \mathbb{R}^2 .
2. Let $B = \{\mathbf{x} \in \mathbb{R}^2 : \|\mathbf{x}\|_2 < 1\}$ and $I = [0, 5]$. The set S defined by

$$S = B \times I = \{\mathbf{x} \in \mathbb{R}^3 : x_1^2 + x_2^2 < 1 \text{ and } 0 \leq x_3 \leq 5\}$$

is a cylinder. The set S is neither closed nor open. The boundary of S is given by

$$\partial S = \partial B \times I \cup B \times \partial I$$

1.4 Sequences in \mathbb{R}^n

We introduce the notion of convergence of a sequence in a normed space and the notion of a normed complete space.

Sequences. A sequence of elements of \mathbb{R}^n is a function $f : \mathbb{N} \rightarrow \mathbb{R}^n$, which associates an element $\mathbf{x}_k = f(k) \in \mathbb{R}^n$ for every $k \in \mathbb{N}$. Sequences are noted $(\mathbf{x}_k)_{k \in \mathbb{N}}$.

Convergent sequence. A sequence $(\mathbf{x}_k)_{k \in \mathbb{N}}$ converges toward $\mathbf{x} \in \mathbb{R}^n$, if for every $\epsilon > 0$, we can associate an integer N_ϵ such that for every $k \geq N_\epsilon$ on a $d_2(\mathbf{x}_k, \mathbf{x}) < \epsilon$. We then write

$$\lim_{k \rightarrow +\infty} \mathbf{x}_k = \mathbf{x}.$$

We also say the sequence $(\mathbf{x}_k)_{k \in \mathbb{N}}$ is *convergent* and has a *limit* $\mathbf{x} \in \mathbb{R}^n$. When the limit exists, it is unique. A sequence that is not convergent is said *divergent*. With this definition the sequence $(\mathbf{x}_k)_{k \in \mathbb{N}}$ converges toward $\mathbf{x} \in \mathbb{R}^n$ if and only if the sequence of distances $(D_k)_{k \in \mathbb{N}}$ given by $D_k = d(\mathbf{x}_k, \mathbf{x})$ converges toward 0:

$$\lim_{k \rightarrow +\infty} \mathbf{x}_k = \mathbf{x} \Leftrightarrow \lim_{k \rightarrow +\infty} d_2(\mathbf{x}_k, \mathbf{x}) = 0. \quad (1.7)$$

Cauchy sequences. A sequence $(\mathbf{x}_k)_{k \in \mathbb{N}}$ is a *Cauchy sequence* if for every $\epsilon > 0$, we can associate an $N = N_\epsilon \in \mathbb{N}$ such that $k, l \geq N$ implies $d_2(\mathbf{x}_k, \mathbf{x}_l) < \epsilon$.

Proposition. Any convergent sequence $(\mathbf{x}_k)_{k \in \mathbb{N}}$ is a Cauchy sequence.

Proof. see Analysis I.

Normed complete space. A normed space $(E, \|\cdot\|)$ is complete if any Cauchy sequence converges relatively to this metric. A normed complete space is called a Banach space.

Example - The Banach space \mathbb{R} . We have shown in Chapter 2.5., Analysis I, that the space \mathbb{R} with the metric $d(x, y) = |x - y|$ is complete. This result is at the base of the corresponding result on the normed space $(\mathbb{R}^n, \|\cdot\|_2)$.

Proposition. A sequence $(\mathbf{x}_k)_{k \in \mathbb{N}}$ converges in the normed space $(\mathbb{R}^n, \|\cdot\|_2)$ if and only if the n numerical sequences $(x_{1,k})_k, \dots, (x_{n,k})_k$ converge. The following theorem follows:

Theorem. Any Cauchy sequence in \mathbb{R}^n converges. Therefore the normed space $(\mathbb{R}^n, \|\cdot\|_2)$ is complete.

Bounded sequences in \mathbb{R}^n . A sequence $(\mathbf{x}_k)_{k \in \mathbb{N}}$ is bounded in $(\mathbb{R}^n, \|\cdot\|_2)$ if there exists a constant $C > 0$ such that $\|\mathbf{x}_k\|_2 \leq C$ for any $k \in \mathbb{N}$. The Bolzano-Weierstrass theorem also applies to bounded sequences in \mathbb{R}^n :

Bolzano-Weierstrass theorem in \mathbb{R}^n . Each bounded sequence $(\mathbf{x}_k)_{k \in \mathbb{N}}$ in \mathbb{R}^n has a convergent subsequence $(\mathbf{x}_{k_j})_{j \in \mathbb{N}}$.

Proof. See the proof of the Bolzano-Weierstrass theorem in \mathbb{C} , Analysis 1.

Sets and sequences in \mathbb{R}^n . Let $S \subset \mathbb{R}^n$. Then $\mathbf{x} \in \bar{S}$ if and only if \mathbf{x} is the limit of a sequence of elements of S . If S is closed and bounded then we can extract a convergent subsequence from any sequence in S . In particular if the sequence is convergent its limit is in S .

1.5 Continuous functions

The concept of continuous functions can be extended to applications $\mathbf{f} : \mathbb{R}^n \rightarrow \mathbb{R}^m$.

Continuous function. A function $\mathbf{f} : \mathbb{R}^n \rightarrow \mathbb{R}^m$ is continuous in $\mathbf{a} \in \mathbb{R}^n$ if

$$\lim_{\mathbf{x} \rightarrow \mathbf{a}} \mathbf{f}(\mathbf{x}) = \mathbf{f}(\mathbf{a}),$$

that is to say, if for each sequence $(\mathbf{x}_k)_{k \in \mathbb{N}}$ in \mathbb{R}^n that converges to \mathbf{a}

$$\lim_{k \rightarrow \infty} \mathbf{f}(\mathbf{x}_k) = \mathbf{f}(\mathbf{a}).$$

Proposition. The function $\mathbf{f} : \mathbb{R}^n \rightarrow \mathbb{R}^m$ is continuous in $\mathbf{a} \in \mathbb{R}^n$ if for each $\epsilon > 0$ there exists $\delta > 0$ such that

$$d_2(\mathbf{x}, \mathbf{a}) < \delta \quad \Rightarrow \quad d_2(\mathbf{f}(\mathbf{x}), \mathbf{f}(\mathbf{a})) < \epsilon.$$

If $m = n = 1$ then $d_2(x, y) = |x - y|$ and we end up with the result about the continuity of a function $f : \mathbb{R} \rightarrow \mathbb{R}$.

Rules of calculation for continuous functions. Linear combinations $\alpha f + \beta g$ of two functions $\mathbf{f}, \mathbf{g} : \mathbb{R}^n \rightarrow \mathbb{R}^m$ that are continuous in $\mathbf{a} \in \mathbb{R}^n$ are continuous in $\mathbf{a} \in \mathbb{R}^n$. The composition of functions also preserves continuity (see Analysis I).

We will now give examples of continuous functions. For linear applications and bilinear forms see Section 1.7.

Example 1. The Euclidean norm $\|\cdot\|_2 : \mathbb{R}^n \rightarrow \mathbb{R}_+$ is continuous over the normed space $(\mathbb{R}^n, \|\cdot\|_2)$. (Idea: prove the inequality $|\|\mathbf{x}\|_2 - \|\mathbf{y}\|_2| \leq \|\mathbf{x} - \mathbf{y}\|_2$.)

Example 2. Every norm $\|\cdot\| : \mathbb{R}^n \rightarrow \mathbb{R}_+$ is continuous over the normed space $(\mathbb{R}^n, \|\cdot\|_2)$. In fact, as above

$$|\|\mathbf{x}\| - \|\mathbf{y}\|| \leq \|\mathbf{x} - \mathbf{y}\|$$

and by the inequality (1.11) $\|\mathbf{x} - \mathbf{y}\| \leq C\|\mathbf{x} - \mathbf{y}\|_2$ the affirmation follows.

Example 3. It is possible to build continuous functions $\mathbf{f} : \mathbb{R}^n \rightarrow \mathbb{R}^m$ from continuous functions $f : \mathbb{R} \rightarrow \mathbb{R}$ using the calculation rules for continuous functions. For example, let $f_i : \mathbb{R} \rightarrow \mathbb{R}$ be continuous in $a_i \in \mathbb{R}$, $i = 1, \dots, n$.

Then $\mathbf{f} : \mathbb{R}^n \rightarrow \mathbb{R}$ defined as $f(\mathbf{x}) = \sum_{i=1}^n f_i(x_i)$, $\mathbf{x} = \sum_{i=1}^n x_i \mathbf{e}_i$ is continuous in $\mathbf{a} = \sum_{i=1}^n a_i \mathbf{e}_i$.

As seen in Analysis I, by the Bolzano-Weierstrass Theorem the following result holds for real continuous functions.

Theorem. Let $M \subset (\mathbb{R}^n, \|\cdot\|_2)$ be closed and bounded and $f : M \rightarrow \mathbb{R}$ be continuous. Then f reaches a maximum and a minimum in M .

Banach fixed point theorem. Let $M \subset (\mathbb{R}^n, \|\cdot\|_2)$ be closed and bounded. Let $f : M \rightarrow M$ be a contraction, that is to say, there exists $0 < q < 1$ such that for each $x, y \in M$

$$d_2(f(x), f(y)) \leq q d_2(x, y). \quad (1.8)$$

Then there exists a unique $\bar{x} \in M$ such that $f(\bar{x}) = \bar{x}$.

Limit of a function. By analogy to Analysis I, we can define the limit of a function $\mathbf{f} : \mathbb{R}^n \rightarrow \mathbb{R}^m$ in $\mathbf{a} \in \mathbb{R}^n$ by the existence of a continuous extension. This concept will be introduced in Chapter 3 for functions $\mathbf{f} : \mathbb{R}^n \rightarrow \mathbb{R}$ to illustrate surprising results of differential calculus.

1.6 Other norms on \mathbb{R}^n

There exists other norms over \mathbb{R}^n for example

$$\|\mathbf{x}\|_1 = \sum_{k=1}^n |x_k| \quad (1.9)$$

$$\|\mathbf{x}\|_\infty = \max_{1 \leq k \leq n} |x_k| \quad (1.10)$$

To prove that the notion of convergence in \mathbb{R}^n does not depend on the choice of the norm we will introduce the notion of norm equivalence. Two norms $\|\cdot\|$ and $\|\cdot\|'$ are equivalent if there exists two constants $C_1, C_2 > 0$ such that for all $\mathbf{x} \in E$:

$$C_1 \|\mathbf{x}\| \leq \|\mathbf{x}\|' \leq C_2 \|\mathbf{x}\|$$

Of course the norms $\|\cdot\|_1, \|\cdot\|_2, \|\cdot\|_\infty$ are equivalent as

$$\frac{1}{\sqrt{n}} \|\mathbf{x}\|_1 \leq \|\mathbf{x}\|_2 \leq \|\mathbf{x}\|_1$$

and

$$\|\mathbf{x}\|_\infty \leq \|\mathbf{x}\|_2 \leq \sqrt{n} \|\mathbf{x}\|_\infty.$$

Let $\|\cdot\|$ be a norm on \mathbb{R}^n . Then there exist a constant $C > 0$ such that

$$\|\mathbf{x}\| \leq C \|\mathbf{x}\|_2 \quad \text{for all } \mathbf{x} \in \mathbb{R}^n. \quad (1.11)$$

In fact, by writing $\mathbf{x} = \sum_{i=1}^n x_i \mathbf{e}_i$, by the properties of a norm and the Cauchy-Schwarz inequality :

$$\|\mathbf{x}\| \leq \sum_{i=1}^n |x_i| \cdot \|\mathbf{e}_i\| \leq \left(\sum_{i=1}^n x_i^2 \right)^{\frac{1}{2}} \left(\sum_{i=1}^n \|\mathbf{e}_i\|^2 \right)^{\frac{1}{2}} = C \|\mathbf{x}\|_2$$

with $C = \left(\sum_{i=1}^n \|\mathbf{e}_i\|^2 \right)^{\frac{1}{2}}$. We will prove that all norms on \mathbb{R}^n are equivalent.

This property implies that the notion of convergence that we have defined with the distance induced by a norm does not depend on the norm we use.

Continuity of norms on \mathbb{R}^n . Each norm $\|\cdot\| : \mathbb{R}^n \rightarrow \mathbb{R}_+$ is continuous over the normed space $(\mathbb{R}^n, \|\cdot\|_2)$. In fact, as above

$$\left| \|\mathbf{x}\| - \|\mathbf{y}\| \right| \leq \|\mathbf{x} - \mathbf{y}\|$$

and from the inequality (1.11): $\|\mathbf{x} - \mathbf{y}\| \leq C \|\mathbf{x} - \mathbf{y}\|_2$, the affirmation follows.

Proposition- Equivalence of norms. Let $\|\cdot\|$ be a norm on \mathbb{R}^n . Then $\|\cdot\|$ is equivalent to $\|\cdot\|_2$.

Proof. $M = \{\mathbf{x} \in \mathbb{R}^n : \|\mathbf{x}\|_2 = 1\}$ is a bounded and closed subset of $(\mathbb{R}^n, \|\cdot\|_2)$. The continuous function $\|\cdot\|$ reaches its maximum and its minimum in M . By the homogeneity of norms there exists $C_1, C_2 > 0$ such that

$$C_1\|\mathbf{x}\|_2 \leq \|\mathbf{x}\| \leq C_2\|\mathbf{x}\|_2 \quad (1.12)$$

for all $\mathbf{x} \in \mathbb{R}^n$. It follows that in \mathbb{R}^n , the notion of an open set does not depend on the norm since all norms are equivalent. For example let

$$B(\mathbf{a}, \epsilon) = \{\mathbf{x} \in \mathbb{R}^n : \|\mathbf{x} - \mathbf{a}\|_2 < \epsilon\}$$

be the ϵ -neighborhoods relatively to the Euclidean norm and

$$B'(\mathbf{a}, \epsilon) = \{\mathbf{x} \in \mathbb{R}^n : \|\mathbf{x} - \mathbf{a}\|_\infty < \epsilon\}$$

the ϵ -neighborhoods relatively to the maximum norm, then we have the following inclusions

$$B'(\mathbf{a}, \epsilon/\sqrt{n}) \subset B(\mathbf{a}, \epsilon) \subset B'(\mathbf{a}, \epsilon).$$

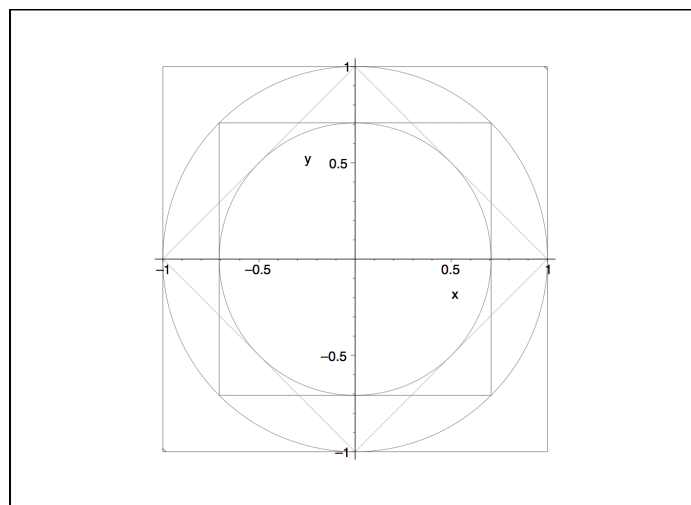

Balls for norms 1, 2, ∞

1.7 Linear applications

For each linear application $\mathbf{f} : \mathbb{R}^n \rightarrow \mathbb{R}^m$, we can associate a matrix $A \in M_{m,n}$ such that

$$\mathbf{f}(\mathbf{x}) = A\mathbf{x} \quad (1.13)$$

for all $\mathbf{x} \in \mathbb{R}^n$. Explicitly, if $A = a_{ij}$, $i = 1 \dots m$, $j = 1 \dots n$, then

$$A\mathbf{x} = \sum_{i=1}^m \sum_{j=1}^n a_{ij}x_j \mathbf{e}_i$$

where $\mathbf{e}_i \in \mathbb{R}^m$ are the vectors of the standard basis. By the Cauchy-Schwarz inequality

$$\|\mathbf{Ax}\|_2^2 = \sum_{i=1}^m \sum_{j=1}^n \sum_{l=1}^n a_{ij} a_{il} x_j x_l = \sum_{i=1}^m \left(\sum_{j=1}^n a_{ij} x_j \right)^2 \leq \left(\sum_{i=1}^m \sum_{j=1}^n a_{ij}^2 \right) \|\mathbf{x}\|_2^2.$$

We say that the application defined by A is bounded since we have a constant $C > 0$ such that

$$\|\mathbf{Ax}\|_2 \leq C \|\mathbf{x}\|_2 \quad (1.14)$$

for all $\mathbf{x} \in \mathbb{R}^n$. Here $C = \|A\|_2 := \left(\sum_{i=1}^m \sum_{j=1}^n a_{ij}^2 \right)^{\frac{1}{2}}$. The continuity of the linear application $\mathbf{f}(\mathbf{x}) = \mathbf{Ax}$ follows.

Proposition. Each linear function $\mathbf{f} : \mathbb{R}^n \rightarrow \mathbb{R}^m$ is bounded and therefore continuous.

Proof. For each $\epsilon > 0$ choose $\delta = C\epsilon^{-1}$ with C of equation (1.14).

Bilinear forms. We can identify matrices $A \in M_{m,n}$ with bilinear forms $b : \mathbb{R}^m \times \mathbb{R}^n \rightarrow \mathbb{R}$ as

$$b(\mathbf{y}, \mathbf{x}) = \langle \mathbf{y}, \mathbf{Ax} \rangle_{\mathbb{R}^m} = \sum_{i=1}^m \sum_{j=1}^n a_{ij} x_j y_i \quad (1.15)$$

Note that

$$b(\mathbf{y}, \mathbf{x}) = \langle A^T \mathbf{y}, \mathbf{x} \rangle_{\mathbb{R}^n}$$

where $A^T \in M_{n,m}$ is the transpose of matrix A . In particular $b(\mathbf{e}_i, \mathbf{e}_j) = a_{ij}$. The bilinear form $b : \mathbb{R}^m \times \mathbb{R}^n \rightarrow \mathbb{R}$ defined by (1.15) is continuous in all $(\mathbf{y}, \mathbf{x}) \in \mathbb{R}^m \times \mathbb{R}^n$.

Chapter 2

Curves in \mathbb{R}^n

2.1 Differentiable curves

Definition. Let $I \subset \mathbb{R}$ be an interval. A curve (or a path) is a continuous function

$$\mathbf{f} : I \longrightarrow \mathbb{R}^n.$$

A curve is an n -tuple of continuous functions f_i :

$$\mathbf{f} = \begin{pmatrix} f_1 \\ \vdots \\ f_n \end{pmatrix}.$$

A curve is differentiable if the n functions f_i are differentiable. A curve is of class $C^k(I)$ if all n functions f_i are of class $C^k(I)$. For all $t \in I$ we call

$$\mathbf{f}'(t) = \begin{pmatrix} f'_1(t) \\ \vdots \\ f'_n(t) \end{pmatrix}$$

the tangent vector at point $\mathbf{f}(t)$.

For a differentiable curve, we have by definition of a derivative

$$\mathbf{f}'(t) = \lim_{\substack{h \rightarrow 0 \\ h \neq 0}} \frac{\mathbf{f}(t+h) - \mathbf{f}(t)}{h}$$

in other words,

$$\mathbf{f}(t+h) = \mathbf{f}(t) + \mathbf{f}'(t)h + \mathbf{o}(h)$$

where $\mathbf{o}(h)$ denotes a continuous curve such that

$$\lim_{h \rightarrow 0} \frac{\mathbf{o}(h)}{|h|} = \mathbf{0}.$$

Application to mechanics. A curve describes the movement of a particle if we interpret the variable t as the time and $\mathbf{f}(t)$ as the position of the particle at time t (in mechanics physical particles may be represented as point particles, that is to say, they lack spatial extension). Then, the image of \mathbf{f} describes the orbit and the graph of \mathbf{f} describes the movement in spacetime. The tangent vector at time t represents the velocity vector and

$$\|\mathbf{f}'(t)\|_2 = \sqrt{f_1'(t)^2 + \dots + f_n'(t)^2}$$

is the speed at time t . The vector

$$\mathbf{f}''(t) = \begin{pmatrix} f_1''(t) \\ \vdots \\ f_n''(t) \end{pmatrix}$$

represents the acceleration at time t . We usually write $\mathbf{r}(t)$, $\mathbf{v}(t)$, $\mathbf{a}(t)$ to denote the position, velocity and acceleration. Time derivatives are often written as $\dot{\mathbf{r}}(t)$, $\ddot{\mathbf{r}}(t)$, \dots . The equation of motion for a particle of mass m is given by Newton's law

$$m\mathbf{a}(t) = \mathbf{F}(t, \mathbf{r}(t), \mathbf{v}(t)) \quad (2.1)$$

where the function F denotes the force that acts on the particle. It is a system of second order differential equations to which we must add initial conditions (see Chapter 7):

$$m\ddot{\mathbf{r}}(t) = \mathbf{F}(t, \mathbf{r}(t), \dot{\mathbf{r}}(t)), \quad \mathbf{r}(0) = \mathbf{r}_0, \quad \dot{\mathbf{r}}(0) = \mathbf{v}_0. \quad (2.2)$$

A system of N particles in \mathbb{R}^3 can be represented by a vector in \mathbb{R}^{3N} . It can be useful to combine the position vector and the velocity vector of a particle of mass m in a single vector

$$\begin{pmatrix} \mathbf{r}(t) \\ \mathbf{v}(t) \end{pmatrix} \quad \text{or} \quad \begin{pmatrix} \mathbf{r}(t) \\ \mathbf{p}(t) \end{pmatrix}$$

where $\mathbf{p}(t) = m\mathbf{v}(t)$ is the momentum of the particle. These vectors belong to a space called the phase space, and is important in physics and for differential equations.

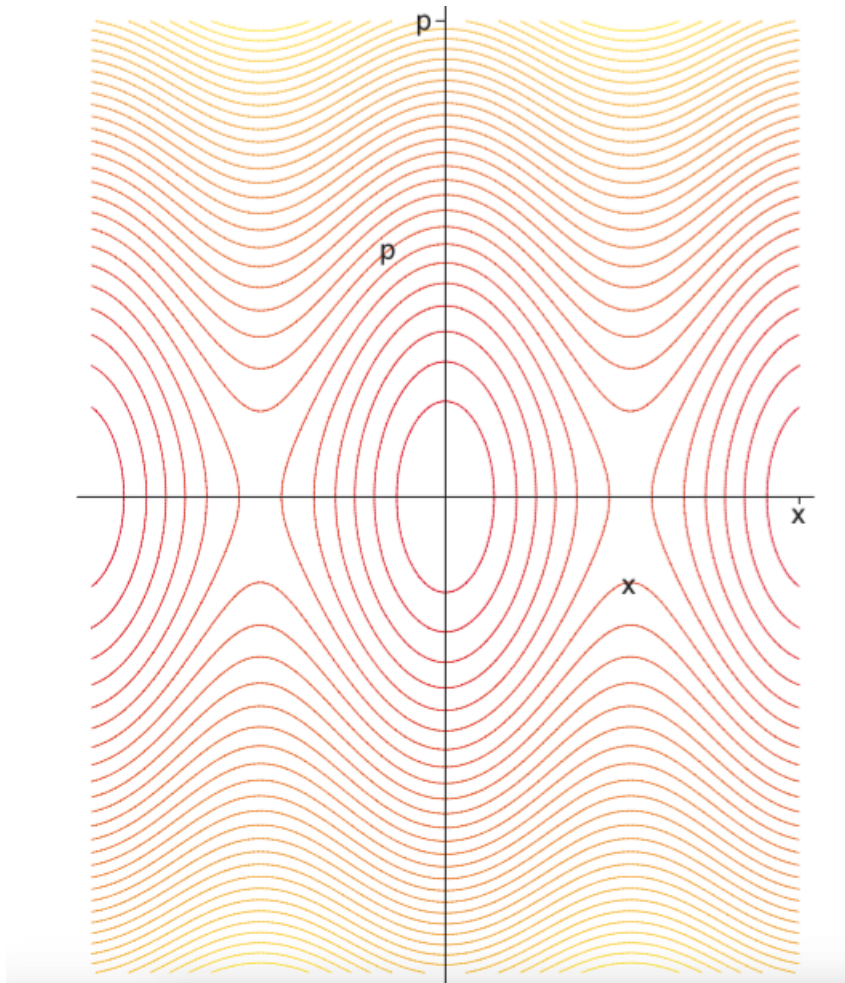

Curves in the phase space of a pendulum $a(t) = -g l \sin(x(t))$.

Definition. A curve is said to be smooth if $\mathbf{f}'(t) \neq \mathbf{0}$ for all $t \in I$. A $t \in I$ such that $\mathbf{f}'(t) = \mathbf{0}$ is singular (or stationary).

Examples.

1. Circles. Let $r > 0$ and $\mathbf{f} : [0, 2\pi] \rightarrow \mathbb{R}^2$ given by

$$\mathbf{f}(t) = \begin{pmatrix} r \cos t \\ r \sin t \end{pmatrix},$$

or in \mathbb{R}^3 by the function

$$\mathbf{f}(t) = \begin{pmatrix} r \cos t \\ r \sin t \\ 0 \end{pmatrix}$$

We note that in \mathbb{R}^2 :

$$\text{Im}(\mathbf{f}) = \mathbf{f}([0, 2\pi]) = \{(x, y) \in \mathbb{R}^2 : x^2 + y^2 = r^2\}.$$

We note that in \mathbb{R}^3 :

$$\text{Im}(\mathbf{f}) = \mathbf{f}([0, 2\pi]) = \{(x, y, z) \in \mathbb{R}^3 : x^2 + y^2 = r^2, z = 0\}.$$

In \mathbb{R}^2 we have

$$\mathbf{f}'(t) = \begin{pmatrix} -r \sin t \\ r \cos t \end{pmatrix} \quad \text{and} \quad \|\mathbf{f}'(t)\|_2 = r$$

or in \mathbb{R}^3 the function

$$\mathbf{f}'(t) = \begin{pmatrix} -r \sin t \\ r \cos t \\ 0 \end{pmatrix} \quad \text{and} \quad \|\mathbf{f}'(t)\|_2 = r$$

This curve is smooth. Also note that $\langle \mathbf{f}'(t), \mathbf{f}(t) \rangle = 0$ and $\mathbf{f}''(t) = -\mathbf{f}(t)$.

2. A line in \mathbb{R}^n . Let $\mathbf{r}_0, \mathbf{v} \in \mathbb{R}^n$, $t_0 \in \mathbb{R}$ $\mathbf{v} \neq \mathbf{0}$ and $\mathbf{r} : \mathbb{R} \rightarrow \mathbb{R}^n$ given by

$$\mathbf{r}(t) = \mathbf{r}_0 + \mathbf{v}(t - t_0).$$

This parametrization of a line describes the movement of a free particle with the initial conditions $\mathbf{r}(t_0) = \mathbf{r}_0, \dot{\mathbf{r}}(t_0) = \mathbf{v}$. The velocity is constant:

$$\dot{\mathbf{r}}(t) = \mathbf{v} \quad \text{and} \quad \|\dot{\mathbf{r}}(t)\|_2 = \|\mathbf{v}\|_2$$

To depict its image in \mathbb{R}^n by a system of equations we need to find $(n-1)$ vectors \mathbf{w}_j that are mutually orthogonal and also orthogonal to \mathbf{v} . We have

$$\text{Im}(\mathbf{r}) = \mathbf{r}(\mathbb{R}) = \{\mathbf{r} \in \mathbb{R}^n : \langle \mathbf{r} - \mathbf{r}_0, \mathbf{w}_j \rangle = 0\}$$

for all $j = 1, \dots, n-1$. A line is described by a linear system of $(n-1)$ independent equations. The line $\mathbf{r}(t) = \mathbf{r}_0 + \mathbf{v}(t - t_0)$ is a smooth curve.

3. Any graph G_f of a real continuous function $f : \mathbb{R} \rightarrow \mathbb{R}$ can be considered as a curve in \mathbb{R}^2 :

$$\mathbf{f}(t) = \begin{pmatrix} t \\ f(t) \end{pmatrix}$$

Obviously $\text{Im}(\mathbf{f}) = G_f$. For the tangent vector we obtain

$$\mathbf{f}'(t) = \begin{pmatrix} 1 \\ f'(t) \end{pmatrix} \quad \text{and} \quad \|\mathbf{f}'(t)\|_2 = \sqrt{1 + f'(t)^2}$$

4. Helix. For $r > 0$ and $c \in \mathbb{R}$ let $\mathbf{f} : \mathbb{R} \rightarrow \mathbb{R}^3$ be given by

$$\mathbf{f}(t) = \begin{pmatrix} r \cos t \\ r \sin t \\ ct \end{pmatrix}$$

The tangent vector is given by

$$\mathbf{f}'(t) = \begin{pmatrix} -r \sin t \\ r \cos t \\ c \end{pmatrix} \quad \text{and} \quad \|\mathbf{f}'(t)\|_2 = \sqrt{r^2 + c^2}$$

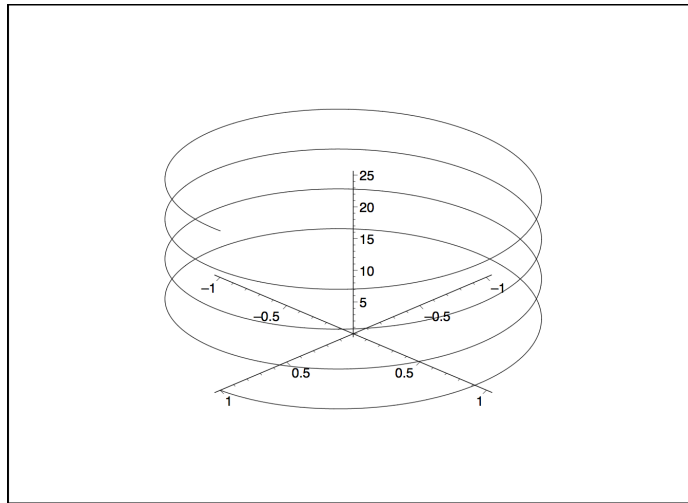

5. A non injective curve. Let $\mathbf{f} : \mathbb{R} \rightarrow \mathbb{R}^2$ be the function

$$\mathbf{f}(t) = \begin{pmatrix} t^2 - 1 \\ t^3 - t \end{pmatrix}$$

We have $\mathbf{f}(-1) = \mathbf{f}(1) = \mathbf{0}$ and

$$\text{Im}(\mathbf{f}) = \mathbf{f}(\mathbb{R}) = \{(x, y) \in \mathbb{R}^2 : x^2 + x^3 = y^2\}$$

We calculate the tangent vectors:

$$\mathbf{f}'(t) = \begin{pmatrix} 2t \\ 3t^2 - 1 \end{pmatrix} \quad \text{and} \quad \|\mathbf{f}'(t)\|_2 = \sqrt{9t^4 - 2t^2 + 1}$$

Therefore $\mathbf{f}'(-1) = (-2, 2)$ and $\mathbf{f}'(1) = (2, 2)$.

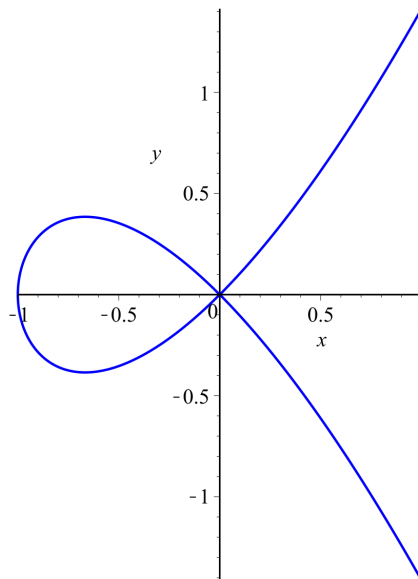

6. Neil Parabola (or semi cubic parabola). We consider the curve $\mathbf{f} : \mathbb{R} \rightarrow \mathbb{R}^2$ given by

$$\mathbf{f}(t) = \begin{pmatrix} t^2 \\ t^3 \end{pmatrix}.$$

Then $\mathbf{f}'(t) = \begin{pmatrix} 2t \\ 3t^2 \end{pmatrix}$. The point $(0, 0)$ is a singular point. The image of \mathbf{f} is given by the equation $x^3 = y^2$.

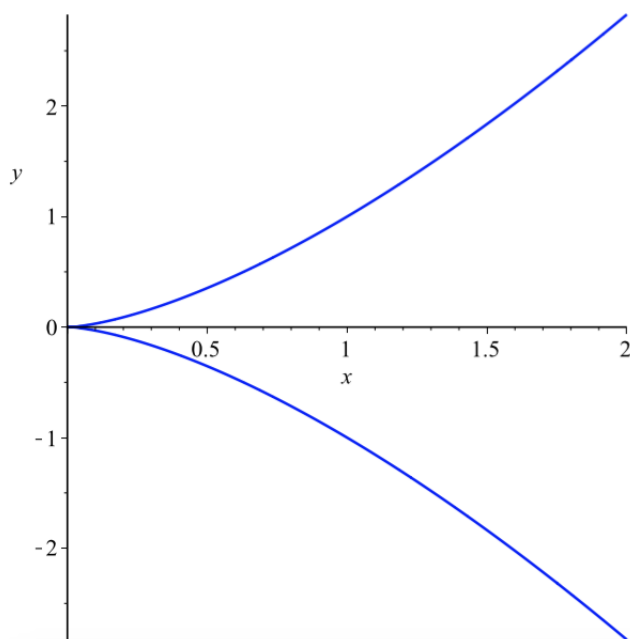

Intersection of smooth curves. Let $\mathbf{f} : I_1 \rightarrow \mathbb{R}^n$, $\mathbf{g} : I_2 \rightarrow \mathbb{R}^n$ be smooth curves such that $\mathbf{f}(t_1) = \mathbf{g}(t_2)$. In other words, $\text{Im}(\mathbf{f}) \cap \text{Im}(\mathbf{g})$ is non empty. The angle of intersection ϑ is defined as the angle between the two tangent vectors. We determine $\vartheta \in [0, \pi]$ by

$$\cos \vartheta = \frac{\langle \mathbf{f}'(t_1), \mathbf{g}'(t_2) \rangle}{\|\mathbf{f}'(t_1)\|_2 \|\mathbf{g}'(t_2)\|_2}$$

Example. Consider example 5. We have $\mathbf{f}(-1) = \mathbf{f}(1) = \mathbf{0}$ and

$$\cos \vartheta = 0$$

i.e $\vartheta = \pi/2$.

2.2 Length of curves

The idea is to approximate a curve by a sequence of segments and from that define the concept of length of a curve.

Length of a segment. Let $\mathbf{f} : I \rightarrow \mathbb{R}^n$ be a curve and $t_1, t_2 \in I$. The segment connecting the points $\mathbf{f}(t_1)$ and $\mathbf{f}(t_2)$ is the straight line $\mathbf{s} : [0, 1] \rightarrow \mathbb{R}^n$ given by

$$\mathbf{s}(\tau) = \mathbf{f}(t_1)(1 - \tau) + \mathbf{f}(t_2)\tau$$

The length of the segment is

$$L(\mathbf{s}) = \|\mathbf{f}(t_2) - \mathbf{f}(t_1)\|_2.$$

Definition - Rectifiable curve. Assume that a curve $\mathbf{f} : [a, b] \rightarrow \mathbb{R}^n$ is partitioned into a sequence of segments $[a, b]$, each of which has a norm tending to zero. If the sequence of the length of these segments converges to a finite number $L > 0$ we call such a curve a rectifiable curve and L the length of the curve \mathbf{f} .

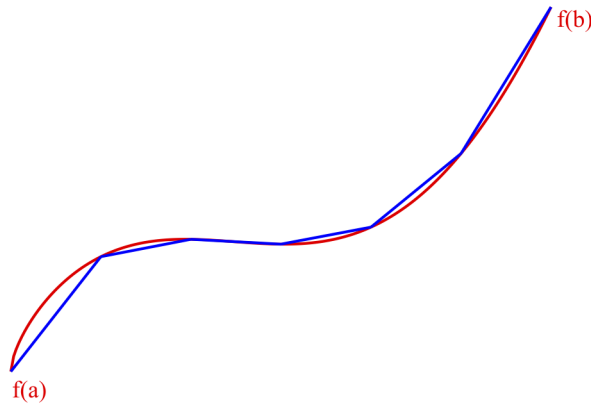

For a differentiable curve \mathbf{f} the idea is to build a Riemann sum for $v(t) = \|\mathbf{f}'(t)\|_2$.

Theorem. Let \mathbf{f} be a curve of class $C^1([a, b])$. Then \mathbf{f} is rectifiable and

$$L = \int_a^b \|\mathbf{f}'(t)\|_2 dt \quad (2.3)$$

We call L the arc-length of \mathbf{f} .

Sketch of proof. Let $N \in \mathbb{Z}_+$. For all $k = 0, \dots, N-1$ let $a_k = a + \frac{k}{N}(b-a)$, using the mean value theorem we have (to use for each f'_i):

$$f_i(a_{k+1}) - f_i(a_k) = \int_{a_k}^{a_{k+1}} f'_i(t) dt = \frac{b-a}{N} f'_i(c_{k,i}), \quad c_{k,i} \in]a_k, a_{k+1}[.$$

Calculating the Euclidean norm and sum over k we obtain:

$$\sum_{k=1}^{N-1} \|\mathbf{f}(a_{k+1}) - \mathbf{f}(a_k)\|_2 = \frac{b-a}{N} \sum_{k=1}^{N-1} \sqrt{\sum_{i=1}^n f'_i(c_{k,i})^2}.$$

Using the uniform continuity of \mathbf{f}' and of the Euclidean norm, the last sum converges to the integral of $\|\mathbf{f}'(t)\|_2$ (exercise!).

Theorem. The length of the arc given by (2.3) does not depend on the parametrization that has been chosen. (see Analysis 3)

An inequality for the length. Let \mathbf{f} be a curve of class $C^1([a, b])$. Then,

$$\left\| \int_a^b \mathbf{f}'(t) dt \right\|_2 \leq \int_a^b \|\mathbf{f}'(t)\|_2 dt,$$

which is equivalent to

$$\|\mathbf{f}(b) - \mathbf{f}(a)\|_2 \leq \int_a^b \|\mathbf{f}'(t)\|_2 dt.$$

Proof. We use the linearity of the integral and the Cauchy-Schwarz inequality for the scalar product in \mathbb{R}^n :

$$\begin{aligned} \|\mathbf{f}(b) - \mathbf{f}(a)\|_2^2 &= \langle \mathbf{f}(b) - \mathbf{f}(a), \mathbf{f}(b) - \mathbf{f}(a) \rangle \\ &= \langle \mathbf{f}(b) - \mathbf{f}(a), \int_a^b \mathbf{f}'(t) dt \rangle \\ &= \int_a^b \langle \mathbf{f}(b) - \mathbf{f}(a), \mathbf{f}'(t) \rangle dt \\ &\leq \int_a^b \|\mathbf{f}(b) - \mathbf{f}(a)\|_2 \|\mathbf{f}'(t)\|_2 dt = \|\mathbf{f}(b) - \mathbf{f}(a)\|_2 \int_a^b \|\mathbf{f}'(t)\|_2 dt. \end{aligned}$$

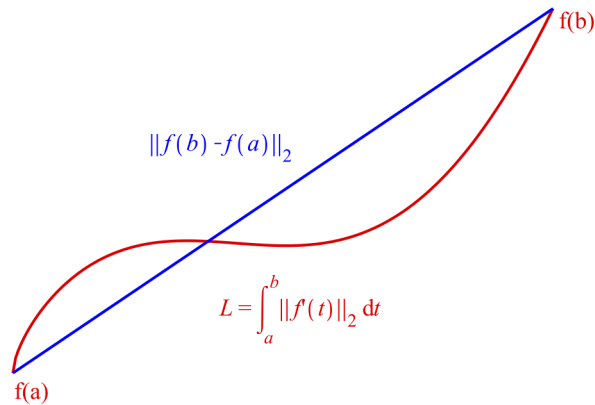

Examples.

1. Arc-length of a circle.

$$L(\alpha) = \int_0^\alpha \|\mathbf{f}'(t)\|_2 dt = r\alpha$$

2. Arc-length of a segment of a straight line.

$$L = \int_a^b \|\mathbf{v}\|_2 dt = \|\mathbf{v}\|_2(b - a)$$

3. The arc-length of a function $f \in C^1([a, b])$ is given by

$$L = \int_a^b \sqrt{1 + f'(t)^2} dt$$

Let us calculate the arc-length of the function $\cosh x$ between $a < b$. Evidently,

$$L = \int_a^b \sqrt{1 + \sinh(t)^2} dt = \int_a^b \cosh t dt = \sinh b - \sinh a.$$

4. Arc-length of a helix.

$$L = \int_0^b \sqrt{r^2 + c^2} dt = b\sqrt{r^2 + c^2}$$

Line integral. Let \mathbf{f} be a curve of class $C^1([a, b])$. For any continuous function $\phi : \mathbb{R}^n \rightarrow \mathbb{R}$ we can define

$$\int_{\text{Im}(\mathbf{f})} \phi \, ds = \int_a^b \phi(\mathbf{f}(t)) \|\mathbf{f}'(t)\|_2 \, dt. \quad (2.4)$$

It is a subject of Analysis 3.

Chapter 3

Real-valued functions in \mathbb{R}^n

3.1 Introduction

Definition. Let $D \subset \mathbb{R}^n$. A function $f : D \rightarrow \mathbb{R}$ is called a real-valued function on $D \subset \mathbb{R}^n$. Given a real number $c \in \text{Im}(f)$, we call the set

$$N_f(c) = \{\mathbf{x} \in D : f(\mathbf{x}) = c\}$$

the level set c of f . The graph of f is given by

$$G_f = \left\{ \begin{pmatrix} \mathbf{x} \\ f(\mathbf{x}) \end{pmatrix} : \mathbf{x} \in D \right\} \subset \mathbb{R}^{n+1}.$$

The graph describes a hypersurface of equation $x_{n+1} = f(\mathbf{x})$ in \mathbb{R}^{n+1} .

The case $n = 2$. For functions $f : \mathbb{R}^2 \rightarrow \mathbb{R}$ we can call the set $N_f(c)$ a contour line. We can consider the value $f(x_1, x_2)$ as the altitude of the point (x_1, x_2) . So $N_f(c)$ corresponds to the contour line c on a geographic map. We can graphically represent a function $f : \mathbb{R}^2 \rightarrow \mathbb{R}$ by its graph in \mathbb{R}^3 or by the projection of its contour lines onto the plane \mathbb{R}^2 .

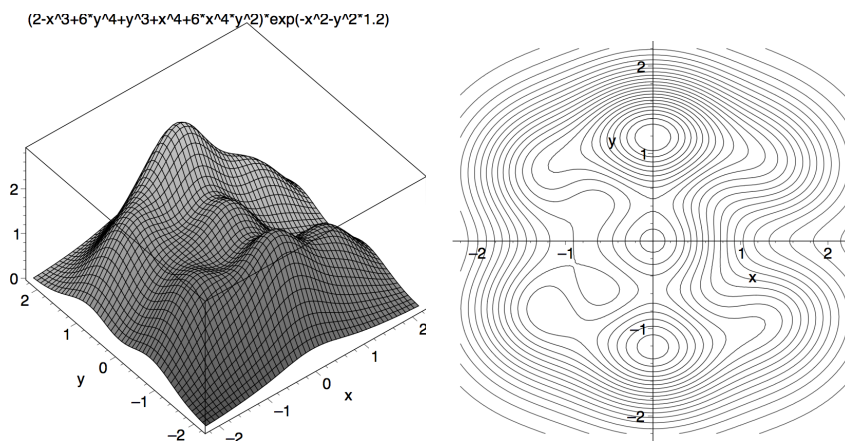

Examples. In physics, the functions $f : \mathbb{R}^n \rightarrow \mathbb{R}$ are often called scalar fields. The gravitational potential of a mass or the electric potential of an electric charge are examples of scalar fields:

$$\phi : \mathbb{R}^3 \setminus \{\mathbf{0}\} \rightarrow \mathbb{R}, \quad \phi(\mathbf{x}) = \frac{k}{\|\mathbf{x}\|_2}$$

for a real constant k . In mechanics, we often consider systems where the energy is conserved (Hamiltonian systems). For the movement of a particle of mass m in space, subject to the potential $V(\mathbf{x})$, its energy is a real-valued function of its momentum $\mathbf{p} = m\mathbf{v}$ here \mathbf{v} is the velocity and \mathbf{x} the position in space:

$$E : \mathbb{R}^n \times \mathbb{R}^n \rightarrow \mathbb{R}, \quad E(\mathbf{p}, \mathbf{x}) = \frac{\|\mathbf{p}\|_2^2}{2m} + V(\mathbf{x}).$$

The movement follows the contour lines of the energy E in phase space.

3.2 Limits and continuity of a real-valued function

We refer to the concepts of limit (and punctured limit) presented in Analysis 1 (see Chapters 2 and 4).

Definition - limit of a function. Let $D \subset \mathbb{R}^n$, $\mathbf{a} \in \mathbb{R}^n$ be a point of closure of D and $f : D \rightarrow \mathbb{R}$ a real-valued function. We say f has a limit $L \in \mathbb{R}$ as \mathbf{x} approaches \mathbf{a} if for any $\epsilon > 0$ there exists a $\delta > 0$ such that $\|\mathbf{x} - \mathbf{a}\|_2 < \delta$ implies $|f(\mathbf{x}) - L| < \epsilon$. In other words, if $\mathbf{a} \in D$ the limit exists if and only if $L = f(\mathbf{a})$, i.e. if and only if f is continuous at \mathbf{a} . If $\mathbf{a} \notin D$ the limit exists if and only if f admits a continuous extension at \mathbf{a} . This definition is equivalent to the definition of limit by sequences (see Analysis 1) : $\lim_{\mathbf{x} \rightarrow \mathbf{a}} f(\mathbf{x}) = L$ if and only if for any sequence $\mathbf{x}_k \in D$, converging toward \mathbf{a} , we have $\lim_{k \rightarrow +\infty} f(\mathbf{a}_k) = L$. In particular if $\mathbf{a} \in D$ we find the definition of a continuous function at $\mathbf{a} \in D$:

Continuous function. A function $f : D \rightarrow \mathbb{R}$ is continuous at $\mathbf{a} \in D$ if for any $\epsilon > 0$ there exists a $\delta > 0$ such that $\|\mathbf{x} - \mathbf{a}\|_2 < \delta$ implies $|f(\mathbf{x}) - f(\mathbf{a})| < \epsilon$. In particular, f commutes with the limit process: for any sequence $\mathbf{a}_k \in D$ converging toward $\mathbf{a} \in D$ we have

$$\lim_{k \rightarrow +\infty} f(\mathbf{a}_k) = f(\mathbf{a}) = f\left(\lim_{k \rightarrow +\infty} \mathbf{a}_k\right).$$

Example. Let $\mathbf{p} \in \mathbb{R}^n$, $f_{\mathbf{p}} : \mathbb{R}^n \rightarrow \mathbb{R}$ be given by $f_{\mathbf{p}}(\mathbf{x}) = \sin\langle \mathbf{p}, \mathbf{x} \rangle$. Then $f_{\mathbf{p}}(\mathbf{x})$ is a continuous function at any $\mathbf{a} \in \mathbb{R}^n$: for any sequence \mathbf{a}_k converging toward \mathbf{a} we have:

$$\lim_{k \rightarrow +\infty} \langle \mathbf{p}, \mathbf{a}_k \rangle = \langle \mathbf{p}, \mathbf{a} \rangle$$

since $|\langle \mathbf{p}, \mathbf{a}_k - \mathbf{a} \rangle| \leq \|\mathbf{a}_k - \mathbf{a}\|_2 \|\mathbf{p}\|_2$ and $\sin(x)$ is continuous.

Non-existence of a limit I. Let $f : \mathbb{R}^2 \rightarrow \mathbb{R}$ be given by

$$f(x, y) = \begin{cases} \frac{xy}{x^2+y^2} & \text{if } (x, y) \neq (0, 0), \\ 0 & \text{if } (x, y) = (0, 0). \end{cases}$$

$f(x, y)$ is not continuous at $(0, 0)$, namely $\lim_{(x,y) \rightarrow (0,0)} f(x, y)$ does not exist. A simple method to prove that the limit does not exist is to study the behaviour of the function f when approaching the point $\mathbf{a} = (0, 0)$ along straight lines passing $(0, 0)$. For example we consider the straight line given by $C = \{(x, y) : y = x\}$. For any point $(x, y) \in C \setminus \{(0, 0)\}$ we have

$$f(x, y) = f(x, x) = \frac{x^2}{x^2 + x^2} = \frac{1}{2}.$$

Then $\lim_{\substack{(x,y) \rightarrow (0,0) \\ (x,y) \in C}} f(x, y) = \lim_{x \rightarrow 0} f(x, x)$ does not exist since $f(0, 0) = 0$.

Non-existence of a punctured limit I.

$$\lim_{\substack{(x,y) \rightarrow (0,0) \\ (x,y) \in C \setminus \{(0,0)\}}} f(x, y) = \lim_{x \rightarrow 0} f(x, x) = \frac{1}{2}.$$

On the straight line $D = \{(x, y) : y = 0\}$, for every point $(x, y) \in D \setminus \{(0, 0)\}$ we have:

$$f(x, y) = f(x, 0) = 0$$

and so

$$\lim_{\substack{(x,y) \rightarrow (0,0) \\ (x,y) \in D \setminus \{(0,0)\}}} f(x, y) = \lim_{x \rightarrow 0} f(x, 0) = 0.$$

We conclude that $\lim_{\substack{(x,y) \rightarrow (0,0) \\ (x,y) \neq (0,0)}} f(x, y)$ does not exist.

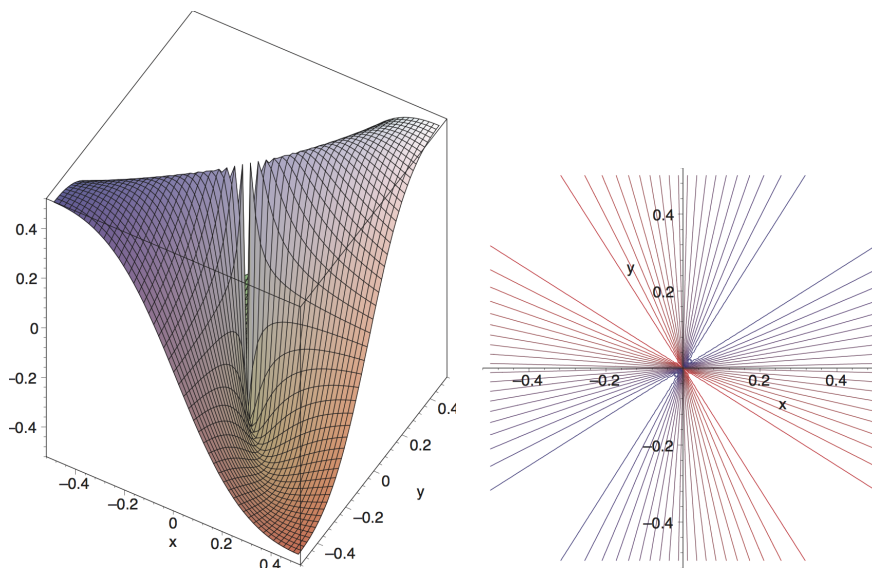

Graph and contour lines of the function $\begin{cases} \frac{xy}{x^2+y^2} & \text{if } (x, y) \neq (0, 0), \\ 0 & \text{if } (x, y) = (0, 0). \end{cases}$

Note that we do not see the discontinuity of the function because the software draws segments between calculated points. As a consequence there is the apparition of "strange" summits.

Parametrized version. In general, for a function $f : \mathbb{R}^n \rightarrow \mathbb{R}$ we consider the lines given by $\mathbf{v}t + \mathbf{a}$, $\mathbf{v} \in S_{n-1} = \{\mathbf{v} \in \mathbb{R}^n : \|\mathbf{v}\|_2 = 1\}$ and we study the functions with one variable t given by

$$g_{\mathbf{v}}(t) = f(\mathbf{v}t + \mathbf{a})$$

when t tends to 0 (with $t \neq 0$ for punctured limits). If we can find two vectors $\mathbf{v}, \mathbf{w} \in S_{n-1}$ such that $g_{\mathbf{v}}(t)$ and $g_{\mathbf{w}}(t)$ do not behave the same way when t approaches 0, then neither the limit nor the punctured limit of f exists. The limit of a function describes its behavior in a neighborhood. That is why it is not sufficient to study the functions $g_{\mathbf{v}}(t)$ for all $\mathbf{v} \in S_{n-1}$, as the following example shows:

Non existence of a limit II. Let $f : \mathbb{R}^2 \rightarrow \mathbb{R}$ be

$$f(x, y) = \begin{cases} 1, & \text{if } y = x^2 \text{ et } x > 0; \\ 0, & \text{otherwise.} \end{cases} \quad (3.1)$$

Of course, f is not continuous at $(0, 0)$ as for each neighborhood of $(0, 0)$: $f(x, x^2) - f(0, 0) = 1$ with $x > 0$ small enough. On the other hand $g_{\mathbf{v}}(t) = 0$ for all $\mathbf{v} \in S_1$ and t small enough.

3.3 Partial derivatives, differential and functions of class C^1

3.3.1 Partial derivatives

Definition A function $f : \mathbb{R}^n \rightarrow \mathbb{R}$ is partially differentiable with respect to the variable x_k at a point $\mathbf{a} \in \mathbb{R}^n$ if the limit

$$\frac{\partial f}{\partial x_k}(\mathbf{a}) = \lim_{\substack{h \rightarrow 0 \\ h \neq 0}} \frac{f(\mathbf{a} + h\mathbf{e}_k) - f(\mathbf{a})}{h} \quad (3.2)$$

exists. The limit $\frac{\partial f}{\partial x_k}(\mathbf{a})$ is called the partial derivative of f with respect to x_k at $\mathbf{a} \in \mathbb{R}^n$.

Remark. We also use the notation

$$D_k f(\mathbf{a}) = \frac{\partial f}{\partial x_k}(\mathbf{a}).$$

or if the real variables of f are explicitly given

$$D_x f(x, y, z) = \frac{\partial f}{\partial x}(x, y, z), D_y f(x, y, z) = \frac{\partial f}{\partial y}(x, y, z), \text{ etc..}$$

Remark. The limit $\frac{\partial f}{\partial x_k}(\mathbf{a})$ exists if and only if the function $h \mapsto f(\mathbf{a} + h\mathbf{e}_k)$ is differentiable at $h = 0$. In that case

$$\frac{\partial f}{\partial x_k}(\mathbf{a}) = \left. \frac{d}{dh} \right|_{h=0} f(\mathbf{a} + h\mathbf{e}_k). \quad (3.3)$$

Calculation rules for partial derivatives. By the remark above, partial derivatives satisfy the properties of linearity and the product and quotient rules (like the derivative of a function of a single variable - see Analysis I):

$$\frac{\partial(\alpha f + \beta g)}{\partial x_k}(\mathbf{a}) = \alpha \frac{\partial f}{\partial x_k}(\mathbf{a}) + \beta \frac{\partial g}{\partial x_k}(\mathbf{a}) \quad (3.4)$$

$$\frac{\partial(f \cdot g)}{\partial x_k}(\mathbf{a}) = g(\mathbf{a}) \frac{\partial f}{\partial x_k}(\mathbf{a}) + f(\mathbf{a}) \frac{\partial g}{\partial x_k}(\mathbf{a}) \quad (3.5)$$

$$\frac{\partial(f/g)}{\partial x_k}(\mathbf{a}) = (g(\mathbf{a}) \frac{\partial f}{\partial x_k}(\mathbf{a}) - f(\mathbf{a}) \frac{\partial g}{\partial x_k}(\mathbf{a})) / g(\mathbf{a})^2. \quad (3.6)$$

For the derivatives of composed functions, see Section 3.5.

Definition. Given $U \in \mathbb{R}^n$. A function $f : U \rightarrow \mathbb{R}$ is partially differentiable in U if the n partial derivatives $D_k f(\mathbf{x})$, $k = 1, \dots, n$ exist for all $\mathbf{x} \in U$. The vector

$$\nabla f(\mathbf{x}) = \begin{pmatrix} D_1 f(\mathbf{x}) \\ \vdots \\ D_n f(\mathbf{x}) \end{pmatrix} = \begin{pmatrix} \frac{\partial f}{\partial x_1}(\mathbf{x}) \\ \vdots \\ \frac{\partial f}{\partial x_n}(\mathbf{x}) \end{pmatrix}$$

is called the gradient of f (at the point \mathbf{x}).

Remark. The gradient is also written $\mathbf{grad}f(\mathbf{x})$. Note that

$$\nabla f(\mathbf{x}) = \sum_{k=1}^n D_k f(\mathbf{x}) \mathbf{e}_k$$

therefore $D_k f(\mathbf{x}) = \langle \nabla f(\mathbf{x}), \mathbf{e}_k \rangle$.

Examples.

1. Let $\mathbf{v} \in \mathbb{R}^n$ be fixed and $l : \mathbb{R}^n \rightarrow \mathbb{R}$, a linear form, be defined as

$$l(\mathbf{x}) = \langle \mathbf{v}, \mathbf{x} \rangle.$$

The function $l(\mathbf{x})$ is partially differentiable and

$$\frac{\partial l}{\partial x_k}(\mathbf{x}) = \lim_{h \rightarrow 0} \frac{l(\mathbf{x} + h\mathbf{e}_k) - l(\mathbf{x})}{h} = \langle \mathbf{v}, \mathbf{e}_k \rangle = v_k.$$

Therefore

$$\nabla l(\mathbf{x}) = \sum_{k=1}^n \langle \mathbf{v}, \mathbf{e}_k \rangle \mathbf{e}_k = \mathbf{v}$$

2. Let $A \in M_{n,n}(\mathbb{R})$ be a symmetric matrix and $q : \mathbb{R}^n \rightarrow \mathbb{R}$ the quadratic form defined as

$$q(\mathbf{x}) = \frac{1}{2} \langle A\mathbf{x}, \mathbf{x} \rangle.$$

The function $q(\mathbf{x})$ is partially differentiable and

$$\frac{\partial q}{\partial x_k}(\mathbf{x}) = \lim_{h \rightarrow 0} \frac{q(\mathbf{x} + h\mathbf{e}_k) - q(\mathbf{x})}{h} = \langle A\mathbf{x}, \mathbf{e}_k \rangle.$$

Therefore

$$\nabla q(\mathbf{x}) = \sum_{k=1}^n \langle A\mathbf{x}, \mathbf{e}_k \rangle \mathbf{e}_k = A\mathbf{x}$$

3. Consider the function $r : \mathbb{R}^n \rightarrow \mathbb{R}$ defined as $r(\mathbf{x}) = \|\mathbf{x}\|_2$. It is partially differentiable in the set $\mathbb{R}^n \setminus \{\mathbf{0}\}$ with

$$\frac{\partial r}{\partial x_k}(\mathbf{x}) = \frac{x_k}{r(\mathbf{x})}.$$

Consequently, its gradient is

$$\nabla r(\mathbf{x}) = \frac{\mathbf{x}}{r(\mathbf{x})} = \frac{\mathbf{x}}{r}.$$

If $f : \mathbb{R} \setminus \{0\} \rightarrow \mathbb{R}$ is differentiable, then the composition $f(r) = f(r(\mathbf{x}))$ is partially differentiable in $\mathbb{R}^n \setminus \{\mathbf{0}\}$ and

$$\nabla f(r) = \frac{f'(r)\mathbf{x}}{r}$$

where f' denotes the derivative of f with respect to the variable r .

4. Let us show that the function $f : \mathbb{R}^2 \rightarrow \mathbb{R}$ defined as

$$f(x, y) = \begin{cases} \frac{xy}{x^2+y^2} & \text{if } (x, y) \neq (0, 0), \\ 0 & \text{if } (x, y) = (0, 0). \end{cases}$$

is partially differentiable in \mathbb{R}^n . First of all, note that for all $(x, y) \neq (0, 0)$ we have

$$\frac{\partial f}{\partial x}(x, y) = \frac{y(y^2 - x^2)}{(x^2 + y^2)^2}$$

and by symmetry

$$\frac{\partial f}{\partial y}(x, y) = \frac{x(x^2 - y^2)}{(x^2 + y^2)^2}.$$

f is also partially differentiable at $(0, 0)$ as

$$\frac{\partial f}{\partial x}(0, 0) = \lim_{h \rightarrow 0} \frac{f(h, 0) - f(0, 0)}{h} = 0$$

and

$$\frac{\partial f}{\partial y}(0, 0) = \lim_{h \rightarrow 0} \frac{f(0, h) - f(0, 0)}{h} = 0.$$

Note that f is not continuous at $(0, 0)$ (see Section 3.2). Therefore, unlike the case $n = 1$, the existence of the partial derivatives does not imply the continuity of a function, the partial derivatives must be continuous as well.

Proposition - The continuity of partial derivatives implies that the function is continuous. Let $f : \mathbb{R}^n \rightarrow \mathbb{R}$ be a function such that all its n partial derivatives exist and are continuous at $\mathbf{a} \in \mathbb{R}^n$. Then, the function f is continuous at \mathbf{a} .

Proof. For $\mathbf{h} \in \mathbb{R}^n$ let $\mathbf{a}_k = \mathbf{a} + \sum_{j=1}^k h_j \mathbf{e}_j$, $k = 0, \dots, n$. Then, $\mathbf{a}_0 = \mathbf{a}$, $\mathbf{a}_n = \mathbf{a} + \mathbf{h}$ et $\mathbf{a}_k - \mathbf{a}_{k-1} = h_k \mathbf{e}_k$, $k = 1, \dots, n$. We write

$$f(\mathbf{a} + \mathbf{h}) - f(\mathbf{a}) = \sum_{k=1}^n f(\mathbf{a}_k) - f(\mathbf{a}_{k-1})$$

By the mean value theorem for single variable functions, for each $k = 1, \dots, n$, there exists $c_k \in \mathbb{R}$, $|c_k| \leq |h_k|$ such that

$$f(\mathbf{a}_k) - f(\mathbf{a}_{k-1}) = h_k \frac{\partial f}{\partial x_k}(\mathbf{a}_{k-1} + c_k \mathbf{e}_k). \quad (3.7)$$

Consequently,

$$\begin{aligned} f(\mathbf{a} + \mathbf{h}) - f(\mathbf{a}) &= \sum_{k=1}^n h_k \frac{\partial f}{\partial x_k}(\mathbf{a}_{k-1} + c_k \mathbf{e}_k) \\ &= \sum_{k=1}^n h_k \left(\frac{\partial f}{\partial x_k}(\mathbf{a}_{k-1} + c_k \mathbf{e}_k) - \frac{\partial f}{\partial x_k}(\mathbf{a}) \right) + \langle \nabla f(\mathbf{a}), \mathbf{h} \rangle \end{aligned} \quad (3.8)$$

The continuity of the partial derivatives and the linear form $\langle \nabla f(\mathbf{a}), \mathbf{h} \rangle$ implies that $f(\mathbf{a} + \mathbf{h}) - f(\mathbf{a}) \rightarrow 0$ as $\mathbf{h} \rightarrow \mathbf{0}$.

3.3.2 Differentiable functions and differential

Definition. A function $f : \mathbb{R}^n \rightarrow \mathbb{R}$ is said to be differentiable at a point $\mathbf{a} \in \mathbb{R}^n$ if and only if there exists a linear form $d_{\mathbf{a}}f(\mathbf{x}) := \langle d_{\mathbf{a}}f, \mathbf{x} \rangle$, called the differential of f at the point \mathbf{a} , such that

$$\lim_{\substack{\mathbf{h} \rightarrow \mathbf{0} \\ \mathbf{h} \neq \mathbf{0}}} \frac{f(\mathbf{a} + \mathbf{h}) - f(\mathbf{a}) - d_{\mathbf{a}}f(\mathbf{h})}{\|\mathbf{h}\|_2} = 0.$$

The differential $d_{\mathbf{a}}f$ is also called the total differential of f at \mathbf{a} . f is said to be differentiable in $U \subset \mathbb{R}^n$, if f is differentiable at each point $\mathbf{a} \in U$.

Directional derivatives. Let $\mathbf{a}, \mathbf{v} \in \mathbb{R}^n$, $\mathbf{v} \neq \mathbf{0}$ and $\mathbf{k} : \mathbb{R} \rightarrow \mathbb{R}^n$ be the straight line given by $\mathbf{k}(t) = \mathbf{a} + \mathbf{v}t$. The derivative

$$\left. \frac{d}{dt} f(\mathbf{a} + \mathbf{v}t) \right|_{t=0}$$

is called the directional derivative of f at \mathbf{a} along the vector \mathbf{v} . If f is differentiable at \mathbf{a} , then

$$\left. \frac{d}{dt} f(\mathbf{a} + \mathbf{v}t) \right|_{t=0} = \langle d_{\mathbf{a}}f, \mathbf{v} \rangle.$$

By taking the directions \mathbf{e}_k we see that any differentiable function at \mathbf{a} is partially differentiable at \mathbf{a} . It follows that for any function that is differentiable at \mathbf{a} :

$$d_{\mathbf{a}}f(\mathbf{v}) = \langle d_{\mathbf{a}}f, \mathbf{v} \rangle = \langle \nabla f(\mathbf{a}), \mathbf{v} \rangle, \quad (3.9)$$

therefore

$$\left. \frac{d}{dt} f(\mathbf{a} + \mathbf{v}t) \right|_{t=0} = \langle \nabla f(\mathbf{a}), \mathbf{v} \rangle.$$

The Taylor expansion at order 1 follows:

Theorem. Let $U \subset \mathbb{R}^n$ be open and $f : U \rightarrow \mathbb{R}$ be differentiable at $\mathbf{a} \in U$. Then,

$$f(\mathbf{a} + \mathbf{h}) = f(\mathbf{a}) + \langle \nabla f(\mathbf{a}), \mathbf{h} \rangle + o(\mathbf{h}) \quad (3.10)$$

and

$$\lim_{\mathbf{h} \rightarrow \mathbf{0}} \frac{o(\mathbf{h})}{\|\mathbf{h}\|_2} = 0.$$

In particular, f is continuous at \mathbf{a} .

Summary. A differentiable function at \mathbf{a} is partially differentiable and continuous at that point. The differential $d_{\mathbf{a}}f$ of f at \mathbf{a} is the linear form $\langle \nabla f(\mathbf{a}), \mathbf{h} \rangle$.

3.3.3 Functions of class C^1

Definition. Let $U \subset \mathbb{R}^n$ be an open set. A function $f : U \rightarrow \mathbb{R}$ is said to be of class $C^1(U)$ if its n partial derivatives exist and are continuous at each $\mathbf{x} \in U$.

Remark. The continuity of the partial derivatives at a point \mathbf{a} implies the continuity of the function at \mathbf{a} (see equation (3.8)). It follows that any function of class $C^1(U)$ is differentiable (and therefore continuous) at each $\mathbf{a} \in U$:

Proposition. Let $U \subset \mathbb{R}^n$ be open and $f : U \rightarrow \mathbb{R}$ of class $C^1(U)$. Then f is differentiable at each $\mathbf{a} \in U$. In particular, f has an expansion of order one (see equation (3.10)) at each $\mathbf{a} \in U$.

Theorem 3.1. - Mean value theorem. Let $U \subset \mathbb{R}^n$ be open and $f : U \rightarrow \mathbb{R}$ of class $C^1(U)$. Let $\mathbf{x}, \mathbf{y} \in U$ be such that the segment defined by $\mathbf{k}(t) := (1-t)\mathbf{x} + t\mathbf{y}$, $0 \leq t \leq 1$, is in U . Then

$$f(\mathbf{y}) - f(\mathbf{x}) = \left\langle \int_0^1 \nabla f((1-t)\mathbf{x} + t\mathbf{y}) dt, \mathbf{y} - \mathbf{x} \right\rangle. \quad (3.11)$$

Proof. We define $g : [0, 1] \rightarrow \mathbb{R}$ as $g(t) := f((1-t)\mathbf{x} + t\mathbf{y})$. Then g is of class C^1 such that $g(0) = f(\mathbf{x})$, $g(1) = f(\mathbf{y})$ and $g'(t) = \langle \nabla f((1-t)\mathbf{x} + t\mathbf{y}), \mathbf{y} - \mathbf{x} \rangle$. Equation (3.11) is equivalent to

$$g(1) - g(0) = \int_0^1 g'(t) dt.$$

□

3.4 Tangent hyperplane

For differentiable functions (we always use functions of class C^1 to simplify the presentation) the geometric interpretation of the linear term $f(\mathbf{a}) + \langle \nabla f(\mathbf{a}), \mathbf{h} \rangle$ is that of the tangent hyperplane, generalizing the notion of the tangent for functions defined in \mathbb{R} .

Example. Let $f : \mathbb{R}^2 \rightarrow \mathbb{R}$ be the function of class C^1 defined as

$$f(x, y) = x^2 + xy - y^2.$$

We have

$$\nabla f(x, y) = \begin{pmatrix} 2x + y \\ -2y + x \end{pmatrix}$$

In a neighborhood of the point $(a, b) = (1, 1)$ the function behaves like

$$\begin{aligned} f(x, y) &\approx f(a, b) + \langle \nabla f(a, b), (x - a, y - b) \rangle \\ &= f(a, b) + (2a + b)(x - a) + (-2b + a)(y - b) \\ &= 1 + 3(x - 1) - (y - 1) \end{aligned}$$

The function $h(x, y) = 1 + 3(x - 1) - (y - 1)$ describes a plane in \mathbb{R}^3 , i.e. the graph G_h is a plane in \mathbb{R}^3 . We have $(a, b, f(a, b)) = (a, b, h(a, b))$, therefore it is a plane containing the point $(a, b, f(a, b))$ of the graph of f and tangent to the graph of f . This plane is a generalization of the tangent line for real valued single variable functions. If we generalize it to \mathbb{R}^n we call it the tangent hyperplane.

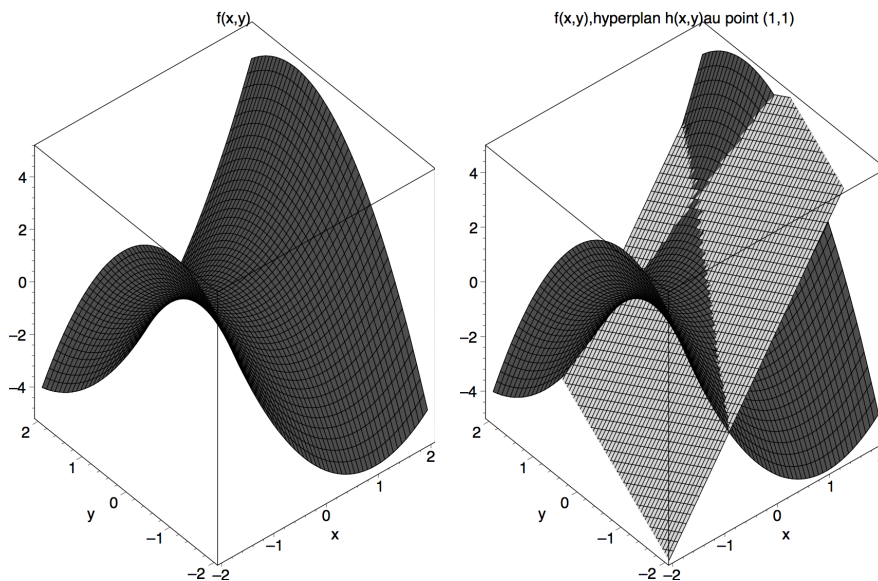

The graph of the function $f(x, y) = x^2 + xy - y^2$ and its hyperplane at the point $(1, 1, 1) \in \mathbb{R}^3$.

Equation of a hyperplane. Given $\mathbf{v} \in \mathbb{R}^n$ and the linear form $l : \mathbb{R}^n \rightarrow \mathbb{R}$ defined as

$$l(\mathbf{x}) = \langle \mathbf{v}, \mathbf{x} \rangle.$$

For all $\mathbf{a} \in \mathbb{R}^n$ and $h \in \mathbb{R}$ the graph of the function

$$h_{\mathbf{a}}(\mathbf{x}) = h + l(\mathbf{x} - \mathbf{a}) = h + \langle \mathbf{v}, \mathbf{x} - \mathbf{a} \rangle$$

defines a hyperplane containing the point $(\mathbf{a}, h) \in \mathbb{R}^{n+1}$. The equation of this hyperplane in \mathbb{R}^{n+1} is given by

$$x_{n+1} = h + \langle \mathbf{v}, \mathbf{x} - \mathbf{a} \rangle = h + \sum_{k=1}^n v_k(x_k - a_k).$$

Tangent hyperplane. If $f : U \rightarrow \mathbb{R}$ is of class $C^1(U)$, then for any $\mathbf{a} \in U$ there exists a neighborhood $V \subset U$ of \mathbf{a} such that

$$f(\mathbf{x}) = f(\mathbf{a}) + \langle \nabla f(\mathbf{a}), \mathbf{x} - \mathbf{a} \rangle + o(\|\mathbf{x} - \mathbf{a}\|).$$

Consequently, the equation of the tangent hyperplane is given by

$$x_{n+1} = f(\mathbf{a}) + \langle \nabla f(\mathbf{a}), \mathbf{x} - \mathbf{a} \rangle.$$

If $n = 1$ we find the equation of the tangent $x_2 = f(a) + f'(a)(x_1 - a)$, known from Analysis 1.

3.5 Gradient and level lines

The composition rule - 1. Let I be an interval and $\mathbf{k} : I \rightarrow \mathbb{R}^n$ a curve of class C^1 . Let $f : \mathbb{R}^n \rightarrow \mathbb{R}$ be a real-valued function of class C^1 . Then the composed function $f \circ \mathbf{k} : I \rightarrow \mathbb{R}$ is of class C^1 and

$$\frac{d}{dt}f(\mathbf{k}(t)) = \langle \nabla f(\mathbf{k}(t)), \mathbf{k}'(t) \rangle.$$

Example. Let $f : \mathbb{R}^2 \rightarrow \mathbb{R}$ be the function defined by

$$f(x, y) = x^2 + y^2$$

and $\mathbf{k} : \mathbb{R} \rightarrow \mathbb{R}^2$ the logarithmic spiral given by

$$\mathbf{k}(t) = (e^{-ct} \cos t, e^{-ct} \sin t), \quad c > 0.$$

Since

$$\nabla f(x, y) = \begin{pmatrix} 2x \\ 2y \end{pmatrix}$$

and

$$\mathbf{k}'(t) = \begin{pmatrix} -ce^{-ct} \cos t - e^{-ct} \sin t \\ -ce^{-ct} \sin t + e^{-ct} \cos t \end{pmatrix}$$

we obtain

$$\begin{aligned} \frac{d}{dt}f(\mathbf{k}(t)) &= 2\mathbf{k}_1(t)\mathbf{k}'_1(t) + 2\mathbf{k}_2(t)\mathbf{k}'_2(t) \\ &= -2ce^{-2ct} \end{aligned}$$

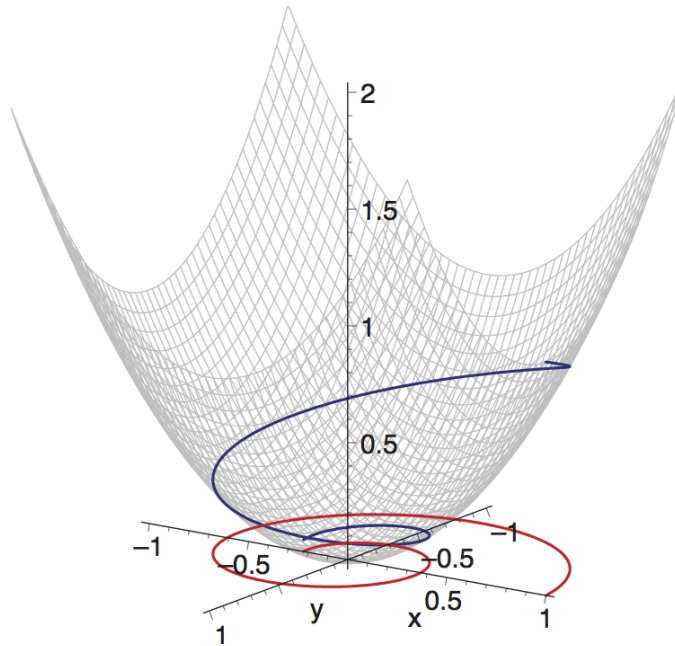

The curve $\mathbf{k}(t)$ is in \mathbb{R}^2 (shown in red) and the curve $\mathbf{c}(t) = \begin{pmatrix} \mathbf{k}(t) \\ f(\mathbf{k}(t)) \end{pmatrix}$ (in blue) is a curve in the graph $G_f \subset \mathbb{R}^3$. The derivative $\frac{d}{dt}f(\mathbf{k}(t))$ shows how the altitude varies depending on t or more precisely, it is the slope of the function f when following the curve $\mathbf{k}(t)$.

Contour lines. If \mathbf{k} is a curve such that

$$f(\mathbf{k}(t)) = c = \text{constant}$$

i.e. \mathbf{k} is a curve in the level set c of f we have

$$\frac{d}{dt}f(\mathbf{k}(t)) = \langle \nabla f(\mathbf{k}(t)), \mathbf{k}'(t) \rangle = \frac{d}{dt} c = 0.$$

We note that the gradient of f is orthogonal to the tangent vector of a contour line, i.e. of a curve in the level set $N_f(c)$.

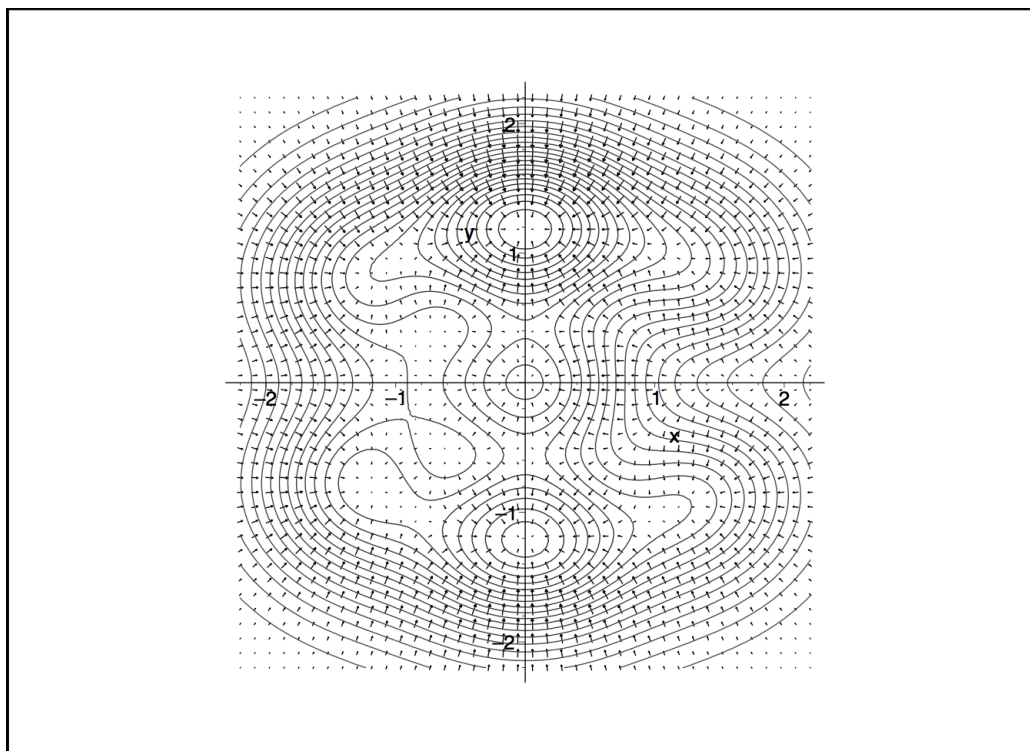

The gradients are orthogonal to the contour lines.

Example. Let $f : \mathbb{R}^2 \rightarrow \mathbb{R}$ be a function of class C^1 given by

$$f(x, y) = x^2 + y^2.$$

We have

$$\nabla f(x, y) = \begin{pmatrix} 2x \\ 2y \end{pmatrix}.$$

The sets of level c of f for $c > 0$ are circles with centre $(0, 0)$ and radius \sqrt{c} . We can represent them in a parametrized form with the curves $\mathbf{k}_c : [0, 2\pi] \rightarrow \mathbb{R}^2$ given by

$$\mathbf{k}_c(t) = \begin{pmatrix} \sqrt{c} \cos t \\ \sqrt{c} \sin t \end{pmatrix}$$

A geometric interpretation of the gradient. We can interpret the derivative

$$\frac{d}{dt}f(\mathbf{k}(t))$$

as the slope of the function f when following the curve $\mathbf{k}(t)$. Using the composition rule we have

$$\frac{d}{dt}f(\mathbf{k}(t)) = \langle \nabla f(\mathbf{k}(t)), \mathbf{k}'(t) \rangle = \|\nabla f(\mathbf{k}(t))\|_2 \|\mathbf{k}'(t)\|_2 \cos \alpha(t)$$

where $\alpha(t)$ is the angle between the gradient of f and the tangent vector of the curve \mathbf{k} at the time t . We see that this value is maximal if $\alpha(t) = 0$. Therefore the vector $\nabla f(\mathbf{a})$ at a point \mathbf{a} points in the direction of the sharpest slope of f .

Composition rule - 2 Let $D \in \mathbb{R}^n$ be open. Let $\rho : D \rightarrow \mathbb{R}$ be a function of class C^1 and $f : \mathbb{R} \rightarrow \mathbb{R}$ be of class C^1 with derivative f' . Then the composition of functions $f \circ \rho : D \rightarrow \mathbb{R}$ is of class C^1 and

$$\nabla f(\rho(\mathbf{x})) = f'(\rho(\mathbf{x}))\nabla\rho(\mathbf{x}).$$

Example. See example 3, Section 3.3.1: if $f = f(r)$ depends only on the radial distance, we have for all $\mathbf{x} \neq \mathbf{0}$:

$$\nabla f(r) = \frac{f'(r)\mathbf{x}}{r}.$$

Example. To find solutions of the partial differential equation

$$\frac{\partial u}{\partial x}(x, y) - \frac{\partial u}{\partial y}(x, y) = 0,$$

note that $u(x, y) = f(x + y)$ (therefore $\rho(x, y) = x + y$) gives a solution for all differentiable f .

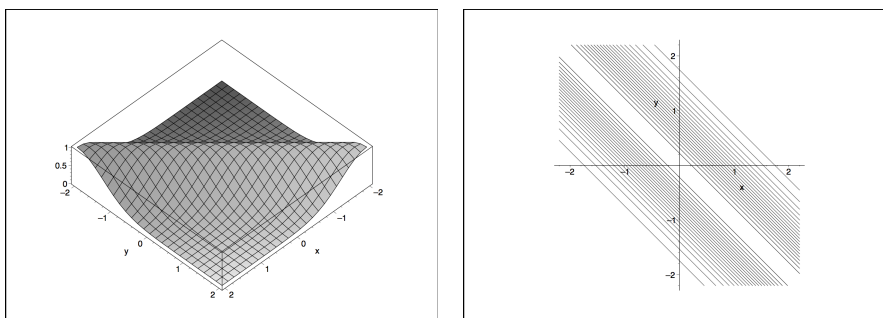

The graph and contour lines of the function $u(x, y) = f(x + y)$.

3.6 Higher order partial derivatives

Let $U \subset \mathbb{R}^n$ be open and $f : U \rightarrow \mathbb{R}$ a partially differentiable function. The partial derivatives $D_k f : U \rightarrow \mathbb{R}$ can also be partially differentiated. In this case we say that f is twice partially differentiable. Therefore the second order partial derivatives $D_j D_k f$ exist.

Example. Let $f : \mathbb{R}^2 \rightarrow \mathbb{R}$ be the real valued function defined as

$$f(x, y) = x^2 \sin y + ye^x$$

Obviously f is of class $C^1(\mathbb{R}^2)$ and

$$D_x f(x, y) = 2x \sin y + ye^x, \quad D_y f(x, y) = x^2 \cos y + e^x$$

The partial derivatives are real valued function of class $C^1(\mathbb{R}^n)$ and we can calculate the four partial derivatives

$$D_x(D_x f(x, y)) = D_{xx} f(x, y), \quad D_y(D_x f(x, y)) = D_{yx} f(x, y)$$

$$D_x(D_y f(x, y)) = D_{xy} f(x, y), \quad D_y(D_y f(x, y)) = D_{yy} f(x, y)$$

We have

$$D_{xx} f(x, y) = 2 \sin y + ye^x, \quad D_{yx} f(x, y) = 2x \cos y + e^x$$

$$D_{xy} f(x, y) = 2x \cos y + e^x, \quad D_{yy} f(x, y) = -x^2 \sin y$$

Note that $D_{xy} f(x, y) = D_{yx} f(x, y)$. It is a general property of partial derivatives under certain hypotheses.

Definition. Let $U \subset \mathbb{R}^n$ be an open set. A function $f : U \rightarrow \mathbb{R}$ is said to be of class $C^m(U)$ if all of its partial derivatives of order m exist and are continuous at \mathbf{x} for all $\mathbf{x} \in U$. The function f is said to be of class $C^\infty(U)$ if each of its successive partial derivatives exist and are continuous at each $\mathbf{x} \in U$.

Theorem. Let $U \subset \mathbb{R}^n$ be an open set and $f : U \rightarrow \mathbb{R}$ be of class $C^2(U)$. Then for each $1 \leq j, k \leq n$ and each $\mathbf{x} \in U$:

$$D_{jk} f(\mathbf{x}) = D_{kj} f(\mathbf{x}).$$

Proof. Explain

Remark. This result can be generalized to partial derivatives of order ≥ 2 . For example, if $f : U \rightarrow \mathbb{R}$ is a function of class $C^3(U)$ we have

$$D_{jkl} f(\mathbf{x}) = D_{kjl} f(\mathbf{x}) = D_{jlk} f(\mathbf{x}) = \dots \text{etc.}$$

There are $\binom{n+m-1}{m}$ partial derivatives of order m (instead of n^m).

Definition. The matrix

$$(D_{jk}f(\mathbf{x}))_{j,k} = \begin{pmatrix} D_{11}f(\mathbf{x}) & \cdots & D_{n1}f(\mathbf{x}) \\ \cdots & \cdots & \cdots \\ D_{1n}f(\mathbf{x}) & \cdots & D_{nn}f(\mathbf{x}) \end{pmatrix}$$

is called the Hessian matrix of f , written $\text{Hess}(f)(\mathbf{x})$.

Remark. Note that

$$\text{Hess}(f)(\mathbf{x}) = (D_1\nabla f(\mathbf{x}) \quad \cdots \quad D_n\nabla f(\mathbf{x})).$$

Definition. Let $U \subset \mathbb{R}^n$ be an open set and $f : U \rightarrow \mathbb{R}$ be of class $C^2(U)$. Then the function $\Delta f : U \rightarrow \mathbb{R}$ defined as

$$\Delta f(\mathbf{x}) = \sum_{k=1}^n D_{kk}f(\mathbf{x})$$

is called the Laplacian of the function f . We call the symbol Δ the Laplacian.

Remark. Note that

$$\Delta f(\mathbf{x}) = \text{tr}(\text{Hess}(f)(\mathbf{x}))$$

where $\text{tr}(A)$ denotes the trace of the matrix A .

Examples.

1. For $\mathbf{v} \in \mathbb{R}^n$, we consider the linear form $l : \mathbb{R}^n \rightarrow \mathbb{R}$ defined as

$$l(\mathbf{x}) = \langle \mathbf{v}, \mathbf{x} \rangle.$$

The function $l(\mathbf{x})$ is of class $C^2(\mathbb{R}^n)$ (even of class $C^\infty(\mathbb{R}^n)$) By Chapter 3.3

$$\nabla l(\mathbf{x}) = \sum_{k=1}^n \langle \mathbf{v}, \mathbf{e}_k \rangle \mathbf{e}_k = \mathbf{v}$$

Therefore

$$\text{Hess}(l)(\mathbf{x}) = 0$$

at all $\mathbf{x} \in \mathbb{R}^n$.

2. Let $A \in M_{n,n}(\mathbb{R})$ be a symmetric matrix and $q : \mathbb{R}^n \rightarrow \mathbb{R}$ the quadratic form defined as

$$q(\mathbf{x}) = \frac{1}{2} \langle A\mathbf{x}, \mathbf{x} \rangle.$$

It is of class $C^2(\mathbb{R}^n)$ (even of class $C^\infty(\mathbb{R}^n)$). By Chapter 3.3

$$\nabla q(\mathbf{x}) = A\mathbf{x}.$$

Then

$$\text{Hess}(q)(\mathbf{x}) = A$$

at all $\mathbf{x} \in \mathbb{R}^n$.

3. Consider the function $r : \mathbb{R}^n \rightarrow \mathbb{R}$ defined as $r(\mathbf{x}) = \|\mathbf{x}\|_2$. It is of class $C^2(\mathbb{R}^n \setminus \{\mathbf{0}\})$ (even of class $C^\infty(\mathbb{R}^n \setminus \{\mathbf{0}\})$). Using

$$\nabla r(\mathbf{x}) = \frac{\mathbf{x}}{r}$$

we find $(D_{jk}f(\mathbf{x}))_{j,k} = \frac{1}{r}\delta_{j,k} - \frac{x_j x_k}{r^3}$ where $\delta_{j,k} = 1$ if $j = k$ and $\delta_{j,k} = 0$ otherwise, i.e.

$$\text{Hess}(r)(\mathbf{x}) = \begin{pmatrix} \frac{1}{r} - \frac{x_1^2}{r^3} & -\frac{x_1 x_2}{r^3} & \dots & -\frac{x_1 x_n}{r^3} \\ -\frac{x_1 x_2}{r^3} & \frac{1}{r} - \frac{x_2^2}{r^3} & \dots & -\frac{x_2 x_n}{r^3} \\ \dots & \dots & \dots & \dots \\ -\frac{x_1 x_n}{r^3} & -\frac{x_2 x_n}{r^3} & \dots & \frac{1}{r} - \frac{x_n^2}{r^3} \end{pmatrix}$$

and

$$\Delta r = \Delta r(\mathbf{x}) = \sum_{k=1}^n \frac{1}{r} - \frac{x_k^2}{r^3} = \frac{n-1}{r}.$$

If $f : \mathbb{R} \setminus \{0\} \rightarrow \mathbb{R}$ is of class $C^2(\mathbb{R} \setminus \{0\})$, then the function composition $f(r) = f(r(\mathbf{x}))$ is of class $C^2(\mathbb{R}^n \setminus \{\mathbf{0}\})$. Its gradient is given by

$$\nabla f(r) = \frac{f'(r)\mathbf{x}}{r}$$

where f' denotes the derivative of f with respect to the variable r . The Hessian of $f(r)$ is given by

$$(D_{jk}f(r))_{j,k} = \frac{f'(r)}{r}\delta_{j,k} + \frac{x_j x_k}{r} \left(\frac{f'(r)}{r}\right)'$$

and in particular

$$\Delta f(r) = \sum_{k=1}^n \frac{f'(r)}{r} + \frac{x_k^2}{r^2} \left(f''(r) - \frac{f'(r)}{r}\right) = f''(r) + \frac{n-1}{r} f'(r).$$

Chapter 4

Vector fields on \mathbb{R}^n

4.1 Derivatives of vector fields

Definition: vector field. Let $U \subset \mathbb{R}^n$. A function $\mathbf{v} : U \rightarrow \mathbb{R}^m$ is called a vector field on U .

Definition: partial derivatives of a vector field and Jacobian matrix. Let $U \subset \mathbb{R}^n$ be open. A function $\mathbf{v} : U \rightarrow \mathbb{R}^m$ is called partially differentiable at $\mathbf{a} \in U$ if the partial derivatives

$$D_j v_i(\mathbf{a}) = \frac{\partial v_i}{\partial x_j}(\mathbf{a}) := \lim_{h \rightarrow 0} \frac{v_i(\mathbf{a} + h\mathbf{e}_j) - v_i(\mathbf{a})}{h}, \quad 1 \leq i \leq m, 1 \leq j \leq n \quad (4.1)$$

exist. The matrix $m \times n$ $J_{\mathbf{v}}(\mathbf{a})$ given by

$$(J_{\mathbf{v}}(\mathbf{a}))_{ij} = (D_j v_i(\mathbf{a}))_{i,j} = \begin{pmatrix} D_1 v_1(\mathbf{a}) & \cdots & D_n v_1(\mathbf{a}) \\ \cdots & \cdots & \cdots \\ D_1 v_m(\mathbf{a}) & \cdots & D_n v_m(\mathbf{a}) \end{pmatrix} \quad (4.2)$$

where $1 \leq i \leq m, 1 \leq j \leq n$ is called the Jacobian matrix of \mathbf{v} at $\mathbf{a} \in U$.

Definition: differentiable vector field. Let $U \subset \mathbb{R}^n$ be open. A function $\mathbf{v} : U \rightarrow \mathbb{R}^m$ is said to be differentiable at $\mathbf{a} \in U$ if there exists a linear map $D_{\mathbf{a}}\mathbf{v}(\mathbf{x}) := J_{\mathbf{v}}(\mathbf{a})\mathbf{x}$, $J_{\mathbf{v}}(\mathbf{a}) \in M_{m,n}$ such that

$$\lim_{\substack{\mathbf{h} \rightarrow \mathbf{0} \\ \mathbf{h} \neq \mathbf{0}}} \frac{\mathbf{v}(\mathbf{a} + \mathbf{h}) - \mathbf{v}(\mathbf{a}) - D_{\mathbf{a}}\mathbf{v}(\mathbf{h})}{\|\mathbf{h}\|_2} = \mathbf{0}. \quad (4.3)$$

Summary. If $\mathbf{v} : U \rightarrow \mathbb{R}^m$ is differentiable at $\mathbf{a} \in U$, then \mathbf{v} is partially differentiable and continuous at that point. Its Jacobian matrix gives the linear mapping that approaches \mathbf{v} in a neighborhood of $\mathbf{a} \in U$.

Definition: vector field of class C^1 . Let $U \subset \mathbb{R}^n$ be open. A function $\mathbf{v} : U \rightarrow \mathbb{R}^m$ is said to be of class $C^1(U)$ if the partial derivatives $D_j v_i : U \rightarrow \mathbb{R}$, $1 \leq i \leq m, 1 \leq j \leq n$ exist and are continuous in U . Extending the result of Chapter 3 we conclude that a vector field of class $C^1(U)$ is differentiable:

Theorem. Let $U \subset \mathbb{R}^n$ be open and $\mathbf{v} : U \rightarrow \mathbb{R}^m$ of class $C^1(U)$. Then for each $\mathbf{a} \in U$, \mathbf{v} is differentiable. In particular,

$$\mathbf{v}(\mathbf{a} + \mathbf{h}) = \mathbf{v}(\mathbf{a}) + J_{\mathbf{v}}(\mathbf{a})\mathbf{h} + \mathbf{o}(\mathbf{h}) \quad (4.4)$$

and

$$\lim_{\mathbf{h} \rightarrow \mathbf{0}} \frac{\mathbf{o}(\mathbf{h})}{\|\mathbf{h}\|_2} = \mathbf{0}.$$

Corollary. Let $U \subset \mathbb{R}^n$ be open. Any vector field $\mathbf{v} : U \rightarrow \mathbb{R}^m$ of class $C^1(U)$ is continuous in U .

Examples.

1. If $f : \mathbb{R} \rightarrow \mathbb{R}$ is differentiable at x , then $J_f(x) = f'(x) \in M_{1,1}(\mathbb{R})$.
2. Let $\mathbf{k} : \mathbb{R} \rightarrow \mathbb{R}^n$ be a differentiable curve at t . Then $J_{\mathbf{k}}(t) = \dot{\mathbf{k}}(t) \in M_{n,1}(\mathbb{R})$.
3. If $f : \mathbb{R}^n \rightarrow \mathbb{R}$ is partially differentiable at \mathbf{x} , then

$$J_f(\mathbf{x}) = (D_1 f(\mathbf{x}), \dots, D_n f(\mathbf{x})) = (\nabla f(\mathbf{x}))^T \in M_{1,n}(\mathbb{R}).$$

If f is differentiable at \mathbf{x} , then $d_{\mathbf{x}}f(\mathbf{h}) = J_f(\mathbf{x}) \cdot \mathbf{h} = \langle \nabla f(\mathbf{x}), \mathbf{h} \rangle$.

4.1.1 The composition rule

Theorem 4.1. Let $U_1 \subset \mathbb{R}^n$, $U_2 \subset \mathbb{R}^m$ be open, $\mathbf{v} : U_1 \rightarrow \mathbb{R}^m$ and $\mathbf{w} : U_2 \rightarrow \mathbb{R}^k$ vector fields of class $C^1(U_1)$ respectively $C^1(U_2)$ such that $\mathbf{v}(U_1) \subset U_2$. Then the vector field

$$\mathbf{w} \circ \mathbf{v} : U_1 \rightarrow \mathbb{R}^k$$

is of class $C^1(U_1)$ and

$$J_{\mathbf{w} \circ \mathbf{v}}(\mathbf{x}) = J_{\mathbf{w}}(\mathbf{v}(\mathbf{x})) \cdot J_{\mathbf{v}}(\mathbf{x}). \quad (4.5)$$

Proof. Write the Taylor expansion of order 1. □

Practical calculation. We see from (4.5) that the elements $(J_{\mathbf{w} \circ \mathbf{v}}(\mathbf{x}))_{i,j}$ can be computed in an intuitive way:

$$\frac{\partial w_i(\mathbf{v}(\mathbf{x}))}{\partial x_j} = \sum_{k=1}^n \frac{\partial v_k}{\partial x_j}(\mathbf{x}) \frac{\partial w_i}{\partial v_k}(\mathbf{v}(\mathbf{x})) \quad (4.6)$$

Examples. In the Chapter 3 we have already seen two examples of the composition rule:

1. Let $f : \mathbb{R}^n \rightarrow \mathbb{R}$, $\mathbf{k} : \mathbb{R} \rightarrow \mathbb{R}^n$ be of class C^1 . Then $f \circ \mathbf{k} : \mathbb{R} \rightarrow \mathbb{R}$ is of class C^1 and $J_{f \circ \mathbf{k}}(t) = \frac{d(f \circ \mathbf{k})(t)}{dt} = J_f(\mathbf{k}(t)) \cdot J_{\mathbf{k}}(t) = \langle \nabla f(\mathbf{k}(t)), \dot{\mathbf{k}}(t) \rangle$.
2. Let $f : \mathbb{R} \rightarrow \mathbb{R}$, $\rho : \mathbb{R}^n \rightarrow \mathbb{R}$ be of class C^1 . Then $f \circ \rho : \mathbb{R}^n \rightarrow \mathbb{R}$ is of class C^1 and $J_{f \circ \rho}(\mathbf{x}) = J_f(\rho(\mathbf{x})) \cdot J_{\rho}(\mathbf{x}) = f'(\rho(\mathbf{x})) \cdot \nabla^T \rho(\mathbf{x})$.

Later we will study the use of the composition rule, for the changes of coordinates.

4.2 Vector fields $\mathbb{R}^n \longrightarrow \mathbb{R}^n$

Introduction. Vector fields $\mathbb{R}^n \longrightarrow \mathbb{R}^n$ have important applications: for example in physics they describe magnetic and electric fields or the velocity field of a fluid. Coordinate changes are also applications $\mathbb{R}^n \longrightarrow \mathbb{R}^n$.

Graphic representation. Let $U \subset \mathbb{R}^n$. A vector field $\mathbf{v} : U \longrightarrow \mathbb{R}^n$ is represented graphically by an arrow (i.e. a vector) attached at each point $\mathbf{x} \in \mathbb{R}^n$. If the application $\mathbf{v} : U \longrightarrow \mathbb{R}^n$ is a change of coordinates, we represent the application $\mathbf{v}(\mathbf{x})$ by the level sets of n real valued functions $v_k : U \longrightarrow \mathbb{R}$.

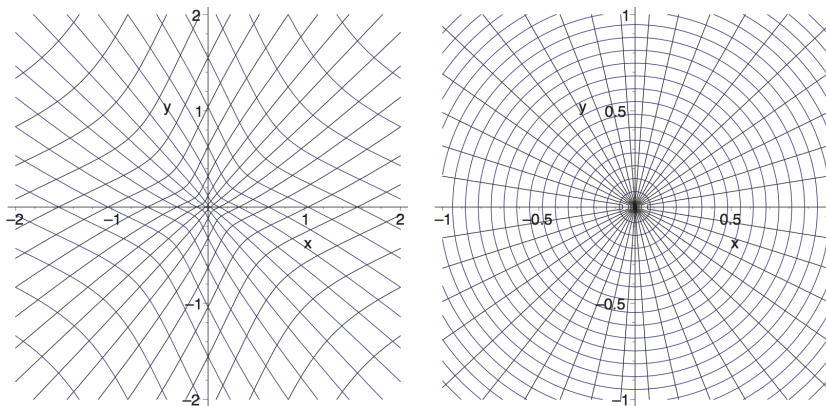
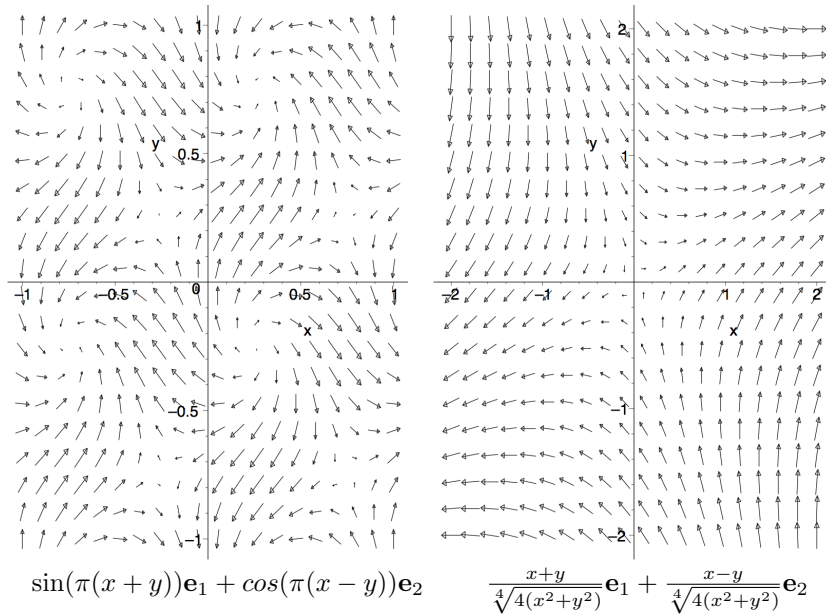

Level set of $\frac{x+y}{\sqrt[4]{4(x^2+y^2)}}$ and $\frac{x-y}{\sqrt[4]{4(x^2+y^2)}}$ respectively of $\sqrt{x^2+y^2}$ and $\arctan(\frac{y}{x})$.

Divergence and Jacobian matrix. The Jacobian matrix $J_{\mathbf{v}}$ is a square matrix. The trace of $J_{\mathbf{v}}$ is called the divergence of the field \mathbf{v} , written $\operatorname{div} \mathbf{v}$:

$$\operatorname{div} \mathbf{v}(\mathbf{x}) = \langle \nabla, \mathbf{v}(\mathbf{x}) \rangle = \operatorname{tr}(J_{\mathbf{v}}(\mathbf{x})) = \sum_{k=1}^n D_k v_k(\mathbf{x}).$$

The determinant, $\det J_{\mathbf{v}(\mathbf{x})}$, is called the Jacobian determinant of \mathbf{v} at $\mathbf{x} \in \mathbb{R}^n$.

Remark. The columns of the Jacobian matrix of a vector field $\mathbf{v}(\mathbf{x})$ are the partial derivatives of $\mathbf{v}(\mathbf{x})$, i.e.

$$J_{\mathbf{v}}(\mathbf{x}) = (D_1 \mathbf{v}(\mathbf{x}) \quad \cdots \quad D_n \mathbf{v}(\mathbf{x})) = \left(\frac{\partial}{\partial x_1} \mathbf{v}(\mathbf{x}) \quad \cdots \quad \frac{\partial}{\partial x_n} \mathbf{v}(\mathbf{x}) \right).$$

Alternatively, the lines of the Jacobian matrix of a vector field $\mathbf{v}(\mathbf{x})$ are the transpose of the gradients of the components $v_x(\mathbf{x})$, i.e.

$$J_{\mathbf{v}}(\mathbf{x}) = \begin{pmatrix} (\nabla v_1(\mathbf{x}))^T \\ \vdots \\ (\nabla v_n(\mathbf{x}))^T \end{pmatrix}.$$

Examples.

1. Let $A \in M_{n,n}(\mathbb{R})$ and $\mathbf{v} : \mathbb{R}^n \rightarrow \mathbb{R}^n$ defined as the linear application

$$\mathbf{v}(\mathbf{x}) = A\mathbf{x}.$$

Then $J_{\mathbf{v}}(\mathbf{x}) = A$ for all $\mathbf{x} \in \mathbb{R}^n$ and $\operatorname{div} \mathbf{v}(\mathbf{x}) = \operatorname{tr}(A)$. Its Jacobian determinant is $\det A$. If matrix A is invertible we can interpret the application given by $A\mathbf{x}$ as a change in coordinates. For example, let $\mathbf{v} : \mathbb{R}^2 \rightarrow \mathbb{R}^2$ be defined as

$$\mathbf{v}(x, y) = \begin{pmatrix} -y \\ x \end{pmatrix} = \begin{pmatrix} 0 & -1 \\ 1 & 0 \end{pmatrix} \begin{pmatrix} x \\ y \end{pmatrix}$$

Then

$$J_{\mathbf{v}}(x, y) = \begin{pmatrix} 0 & -1 \\ 1 & 0 \end{pmatrix}$$

2. Let $U \subset \mathbb{R}^n$ be open and $f : U \rightarrow \mathbb{R}$ be a real-valued function of class $C^2(U)$. Then the gradient of f defines a vector field $\mathbf{v} : U \rightarrow \mathbb{R}^n$ of class $C^1(U)$ given by

$$\mathbf{v}(\mathbf{x}) = \nabla f(\mathbf{x}).$$

Then $J_{\mathbf{v}}(\mathbf{x}) = J_{\nabla f}(\mathbf{x}) = \operatorname{Hess}(f)$ and $\operatorname{div} \mathbf{v}(\mathbf{x}) = \operatorname{tr}(\operatorname{Hess}(f))$. In other words,

$$\operatorname{div}(\nabla f(\mathbf{x})) = \Delta f(\mathbf{x}) \tag{4.7}$$

3. Consider the application $\mathbf{v} : \mathbb{R}^2 \rightarrow \mathbb{R}^2$ defined as

$$\mathbf{v}(r, \phi) = \begin{pmatrix} r \cos \phi \\ r \sin \phi \end{pmatrix}.$$

This application gives the coordinate change from polar coordinates to Cartesian coordinates by

$$\begin{aligned}x &= v_1(r, \phi) = r \cos \phi \\y &= v_2(r, \phi) = r \sin \phi\end{aligned}$$

Its Jacobian matrix is

$$\begin{aligned}J_{\mathbf{v}}(r, \phi) &= \begin{pmatrix} D_1 v_1(r, \phi) & D_2 v_1(r, \phi) \\ D_1 v_2(r, \phi) & D_2 v_2(r, \phi) \end{pmatrix} \\ &= \begin{pmatrix} D_r v_1(r, \phi) & D_\phi v_1(r, \phi) \\ D_r v_2(r, \phi) & D_\phi v_2(r, \phi) \end{pmatrix} \\ &= \begin{pmatrix} \cos \phi & -r \sin \phi \\ \sin \phi & r \cos \phi \end{pmatrix}\end{aligned}$$

and $\det(J_{\mathbf{v}}) = r$.

4. Let $\mathbf{v} : \mathbb{R}^3 \rightarrow \mathbb{R}^3$ be the transformatin defined as

$$\mathbf{v}(r, \theta, \phi) = \begin{pmatrix} r \sin \theta \cos \phi \\ r \sin \theta \sin \phi \\ r \cos \theta \end{pmatrix}.$$

This transformation gives the coordinate change from spherical coordinates to Cartesian coordinates by

$$\begin{aligned}x &= v_1(r, \theta, \phi) = r \sin \theta \cos \phi \\y &= v_2(r, \theta, \phi) = r \sin \theta \sin \phi \\z &= v_3(r, \theta, \phi) = r \cos \theta\end{aligned}$$

Its Jacobian matrix is

$$\begin{aligned}D\mathbf{v}(r, \theta, \phi) &= \begin{pmatrix} D_1 v_1(r, \theta, \phi) & D_2 v_1(r, \theta, \phi) & D_3 v_1(r, \theta, \phi) \\ D_1 v_2(r, \theta, \phi) & D_2 v_2(r, \theta, \phi) & D_3 v_2(r, \theta, \phi) \\ D_1 v_3(r, \theta, \phi) & D_2 v_3(r, \theta, \phi) & D_3 v_3(r, \theta, \phi) \end{pmatrix} \\ &= \begin{pmatrix} D_r v_1(r, \theta, \phi) & D_\theta v_1(r, \theta, \phi) & D_\phi v_1(r, \theta, \phi) \\ D_r v_2(r, \theta, \phi) & D_\theta v_2(r, \theta, \phi) & D_\phi v_2(r, \theta, \phi) \\ D_r v_3(r, \theta, \phi) & D_\theta v_3(r, \theta, \phi) & D_\phi v_3(r, \theta, \phi) \end{pmatrix} \\ &= \begin{pmatrix} \sin \theta \cos \phi & r \cos \theta \cos \phi & -r \sin \theta \sin \phi \\ \sin \theta \sin \phi & r \cos \theta \sin \phi & r \sin \theta \cos \phi \\ \cos \theta & -r \sin \theta & 0 \end{pmatrix}\end{aligned}$$

and $\det(J_{\mathbf{v}}) = r^2 \sin \theta$.

5. Let $U = \mathbb{R}^n \setminus \{\mathbf{0}\}$ and $\mathbf{v} : U \rightarrow \mathbb{R}^n$ be the vector field defined as

$$\mathbf{v}(\mathbf{x}) = \frac{\mathbf{x}}{r}$$

where $r = \|\mathbf{x}\|_2$. Note that $\frac{\mathbf{x}}{r} = \nabla r$. Therefore $\operatorname{div} \mathbf{v}(\mathbf{x}) = \Delta r = (n-1)/r$.

Application of the product rule. Let $U \subset \mathbb{R}^n$ be open, and $f : U \rightarrow \mathbb{R}$ a real valued function of class $C^1(U)$ and $\mathbf{v} : U \rightarrow \mathbb{R}^n$ a vector field of class $C^1(U)$. Then for each $\mathbf{x} \in \mathbb{R}^n$ and each $k = 1, \dots, n$

$$D_k(fv_k)(\mathbf{x}) = f(\mathbf{x})D_kv_k(\mathbf{x}) + D_kf(\mathbf{x})v_k(\mathbf{x})$$

and by summing on $k = 1, \dots, n$

$$\operatorname{div}(f\mathbf{v}(\mathbf{x})) = f(\mathbf{x}) \cdot \operatorname{div} \mathbf{v}(\mathbf{x}) + \langle \nabla f(\mathbf{x}), \mathbf{v}(\mathbf{x}) \rangle$$

or as a scalar product:

$$\langle \nabla, f\mathbf{v} \rangle = f\langle \nabla, \mathbf{v} \rangle + \langle \nabla f, \mathbf{v} \rangle$$

4.2.1 Rotation

Definition. Let $U \subset \mathbb{R}^n$ be open and $\mathbf{v} : U \rightarrow \mathbb{R}^3$ a vector field of class $C^1(U)$. We call rotation of \mathbf{v} the vector field $\mathbf{rot} \mathbf{v} : U \rightarrow \mathbb{R}^3$ defined as

$$\mathbf{rot} \mathbf{v}(\mathbf{x}) = \begin{pmatrix} D_2v_3(\mathbf{x}) - D_3v_2(\mathbf{x}) \\ D_3v_1(\mathbf{x}) - D_1v_3(\mathbf{x}) \\ D_1v_2(\mathbf{x}) - D_2v_1(\mathbf{x}) \end{pmatrix}.$$

We can write the rotation of a vector field as the cross product of the operator ∇ with \mathbf{v} :

$$\mathbf{rot} \mathbf{v}(\mathbf{x}) = \nabla \times \mathbf{v}(\mathbf{x})$$

Rotation of a gradient. Let $f : U \rightarrow \mathbb{R}$ be a real valued function of class $C^2(U)$. Then

$$\mathbf{rot} \operatorname{grad} f(\mathbf{x}) = \mathbf{0}$$

or using the representation by the cross product,

$$\nabla \times \nabla f(\mathbf{x}) = \mathbf{0}.$$

This gives us the necessary condition for a vector field to be the gradient of a real valued function. For the sufficient condition see Analysis 3.

Divergence of the rotation. Let $\mathbf{v} : U \rightarrow \mathbb{R}^3$ be a vector field of class $C^2(U)$. Then

$$\operatorname{div}(\mathbf{rot} \mathbf{v}(\mathbf{x})) = \mathbf{0}$$

using the representation with cross product and scalar product:

$$\langle \nabla, \nabla \times \mathbf{v}(\mathbf{x}) \rangle = 0.$$

This gives us the necessary condition for a vector field to be the rotation of a vector field. For the sufficient condition see Analysis 3.

Example - A constant magnetic field. Let $B > 0$ and \mathbf{A} the potential given by

$$\mathbf{A}(x, y, z) = \begin{pmatrix} -By/2 \\ Bx/2 \\ 0 \end{pmatrix} = -By/2\mathbf{e}_1 + Bx/2\mathbf{e}_2.$$

We have

$$\nabla \times \mathbf{A}(x, y, z) = \begin{pmatrix} 0 \\ 0 \\ B \end{pmatrix} = B\mathbf{e}_3.$$

If f is a real valued function of class C^1 , the rotation of $\mathbf{A} + \nabla f$ is always $B\mathbf{e}_3$. This property is called gauge invariance.

Rotation in two dimensions. For a vector field $\mathbf{v} : \mathbb{R}^2 \rightarrow \mathbb{R}^2$ we can define the rotation as the scalar

$$\text{rot } \mathbf{v}(\mathbf{x}) = D_1v_2(\mathbf{x}) - D_2v_1(\mathbf{x})$$

If $f : \mathbb{R}^2 \rightarrow \mathbb{R}$ is a real valued function of class $C^2(U)$, we have again

$$\text{rot } \mathbf{grad } f(\mathbf{x}) = 0$$

and with the cross product representation:

$$\nabla \times \nabla f(\mathbf{x}) = 0.$$

4.2.2 Invertibility of vector fields

Invertibility of vector fields. Let $U, V \subset \mathbb{R}^n$ be open. If the vector field $\mathbf{v} : U \rightarrow V$ is a bijective application, then the inverse application $\mathbf{w} = \mathbf{v}^{-1} : V \rightarrow U$ exists and:

$$(\mathbf{w} \circ \mathbf{v})(\mathbf{x}) = \mathbf{x}, \quad (\mathbf{v} \circ \mathbf{w})(\mathbf{y}) = \mathbf{y}$$

for all $\mathbf{x} \in U$ and $\mathbf{y} \in V$.

Inversibility - necessary condition. Let $U \subset \mathbb{R}^n$ be open, $\mathbf{v} : U \rightarrow \mathbb{R}^n$ a vector field of class $C^1(U)$. If \mathbf{v} is invertible, with $\mathbf{w} = \mathbf{v}^{-1}$ the inverse function of class C^1 , then

$$J_{\mathbf{w} \circ \mathbf{v}}(\mathbf{x}) = Id_n = J_{\mathbf{w}}(\mathbf{v}(\mathbf{x})) \cdot J_{\mathbf{v}}(\mathbf{x}) \quad (4.8)$$

and

$$\det J_{\mathbf{w} \circ \mathbf{v}}(\mathbf{x}) = 1 = \det J_{\mathbf{w}}(\mathbf{v}(\mathbf{x})) \cdot \det J_{\mathbf{v}}(\mathbf{x}). \quad (4.9)$$

Consequently, if \mathbf{v} is invertible, then $\det J_{\mathbf{v}}(\mathbf{x}) \neq 0$. Equality (4.9) allows us to calculate the Jacobian matrix of the inverse field at $\mathbf{v}(\mathbf{x})$.

Example 1. The function $\mathbf{v} : \mathbb{R}^2 \setminus \{(0, 0)\} \rightarrow \mathbb{R}^2$ defined as

$$\mathbf{v}(x, y) = \frac{1}{\sqrt{x^2 + y^2}} \begin{pmatrix} -y \\ x \end{pmatrix}$$

is not invertible because

$$D\mathbf{v}(x, y) = \begin{pmatrix} D_1v_1(x, y) & D_2v_1(x, y) \\ D_1v_2(x, y) & D_2v_2(x, y) \end{pmatrix} = \frac{1}{\sqrt{x^2 + y^2}^3} \begin{pmatrix} xy & -x^2 \\ y^2 & -xy \end{pmatrix}$$

and its Jacobian determinant is always zero.

Example 2. Let $\mathbf{v} : \mathbb{R}^2 \setminus \{(0, 0)\} \rightarrow \mathbb{R}^2$ be defined as

$$\mathbf{v}(x, y) = \begin{pmatrix} x^2 - y^2 \\ 2xy \end{pmatrix}.$$

Its Jacobian matrix is

$$J_{\mathbf{v}}(x, y) = \begin{pmatrix} D_1 v_1(x, y) & D_2 v_1(x, y) \\ D_1 v_2(x, y) & D_2 v_2(x, y) \end{pmatrix} = \begin{pmatrix} 2x & -2y \\ 2y & 2x \end{pmatrix}.$$

Its Jacobian determinant is $4x^2 + 4y^2 > 0$. The function $\mathbf{v} : \mathbb{R}^2 \setminus \{(0, 0)\} \rightarrow \mathbb{R}^2$ is not bijective since $\mathbf{v}(x, y) = \mathbf{v}(-x, -y)$. Therefore, \mathbf{v} is not invertible in its domain.

Locally invertible functions. The following theorem shows that a vector field of class C^1 is always invertible in the neighborhood of a point \mathbf{a} if its Jacobian determinant is non zero at \mathbf{a} .

Inverse function theorem. Let $U \subset \mathbb{R}^n$ be open. If the Jacobian determinant of a vector field $\mathbf{v} : U \rightarrow \mathbb{R}^n$ of class C^1 is non zero at $\mathbf{a} \in U$, then \mathbf{v} is locally invertible around the point $\mathbf{a} \in U$ with an inverse function of class C^1 .

Remark. An application of this theorem is the implicit function theorem. We will apply the inverse function theorem later on to the change of coordinate systems. Its proof is based on the fixed point Banach theorem given in Chapter 1.

SUPPLEMENT - Proof. Without loss of generality we can assume $\mathbf{a} = \mathbf{0}$, $\mathbf{v}(\mathbf{a}) = \mathbf{0}$ and $J_{\mathbf{v}}(\mathbf{a}) = E_n$ where E_n represents the identity matrix (note that the transformation $\mathbf{u}(\mathbf{x}) = A(\mathbf{v}(\mathbf{x} + \mathbf{a}) - \mathbf{v}(\mathbf{a}))$ where $A = J_{\mathbf{v}}(\mathbf{a})^{-1}$ gives the vector field with these properties). Consequently,

$$\mathbf{v}(\mathbf{h}) = \mathbf{h} + \mathbf{o}(\mathbf{h}).$$

We define $\mathbf{g}(\mathbf{h}) = \mathbf{h} - \mathbf{v}(\mathbf{h})$. Using the mean value theorem (see Chapter 3, Equation (3.11)) applied to a ball $B_{\delta}(\mathbf{0})$ we obtain:

$$\mathbf{g}(\mathbf{x}_2) - \mathbf{g}(\mathbf{x}_1) = \int_0^1 J_{\mathbf{g}}(\mathbf{k}(t))(\mathbf{x}_2 - \mathbf{x}_1) dt$$

where $\mathbf{k}(t) = (1-t)\mathbf{x}_1 + t\mathbf{x}_2$ is the segment between $\mathbf{x}_1, \mathbf{x}_2 \in B_{\delta}(\mathbf{0})$ (which is in $B_{\delta}(\mathbf{0})$). By the continuity of $J_{\mathbf{v}}(\mathbf{x})$ and so of $J_{\mathbf{g}}(\mathbf{x})$ with $J_{\mathbf{g}}(\mathbf{0}) = 0$ there exists a $\delta > 0$ such that $\|J_{\mathbf{g}}(\mathbf{x})\|_2 \leq \frac{1}{2}$ in $B_{\delta}(\mathbf{0})$ and so for every $\mathbf{x}_j, \|\mathbf{x}_j\|_2 \leq \delta, j = 1, 2$:

$$\|\mathbf{g}(\mathbf{x}_2) - \mathbf{g}(\mathbf{x}_1)\|_2 \leq \frac{1}{2} \|\mathbf{x}_2 - \mathbf{x}_1\|_2. \quad (4.10)$$

In particular, $\mathbf{g} : \overline{B}_{\delta}(\mathbf{0}) \rightarrow \overline{B}_{\delta/2}(\mathbf{0})$ (take $\mathbf{x}_2 = \mathbf{0}$). For each $\mathbf{y} \in \overline{B}_{\delta/2}(\mathbf{0})$ we define a function $\mathbf{g}_{\mathbf{y}} : \overline{B}_{\delta}(\mathbf{0}) \rightarrow \overline{B}_{\delta}(\mathbf{0})$ by

$$\mathbf{g}_{\mathbf{y}}(\mathbf{x}) = \mathbf{y} + \mathbf{g}(\mathbf{x}) \quad (4.11)$$

By (4.10) the function $\mathbf{g}_{\mathbf{y}}$ is a contraction on the complete metric space $\overline{B}_{\delta}(\mathbf{0})$. Therefore it has a unique fixed point $\bar{\mathbf{x}}_{\mathbf{y}} \in \overline{B}_{\delta}(\mathbf{0})$. In other words, for each $\mathbf{y} \in \overline{B}_{\delta/2}(\mathbf{0})$ there exists a unique $\bar{\mathbf{x}}_{\mathbf{y}} \in \overline{B}_{\delta}(\mathbf{0})$ such that $\mathbf{y} = \mathbf{v}(\bar{\mathbf{x}}_{\mathbf{y}})$.

Linear functions. For linear functions the condition $\det J_{\mathbf{v}}(\mathbf{x}) \neq 0$ is necessary and sufficient: let $A \in M_{n,n}(\mathbb{R})$ and $\mathbf{v} : \mathbb{R}^n \rightarrow \mathbb{R}^n$ be given by

$$\mathbf{v}(\mathbf{x}) = A\mathbf{x}.$$

Then $J_{\mathbf{v}}(\mathbf{x}) = A$ for every $\mathbf{x} \in \mathbb{R}^n$ and the field \mathbf{v} is invertible if and only if the matrix A is invertible. In this case,

$$\mathbf{w}(\mathbf{x}) = \mathbf{v}^{-1}(\mathbf{x}) = A^{-1}\mathbf{x}.$$

A necessary and sufficient condition so that the matrix A is invertible is $\det A \neq 0$.

The case $n = 2$. For $a, b, c, d \in \mathbb{R}$ let

$$A = \begin{pmatrix} a & b \\ c & d \end{pmatrix}$$

be a matrix such that $\det A = ad - bc \neq 0$. Then

$$A^{-1} = \frac{1}{ad - bc} \begin{pmatrix} d & -b \\ -c & a \end{pmatrix}.$$

Example 2 - continued. Again, we consider the function $\mathbf{v} : \mathbb{R}^2 \setminus \{(0, 0)\} \rightarrow \mathbb{R}^2$ given by

$$\mathbf{v}(x, y) = \begin{pmatrix} x^2 - y^2 \\ 2xy \end{pmatrix}.$$

By the inverse function theorem \mathbf{v} is locally invertible around any point $(a, b) \in \mathbb{R}^2 \setminus \{(0, 0)\}$. To compute its inverse we need to solve the system

$$x^2 - y^2 = s, 2xy = t \tag{4.12}$$

for (x, y) . We are also trying to determine the maximum open domain on which \mathbf{v} is invertible. In the next part we will prove that the system has a unique solution (x, y) if $x > 0$, that is that the function

$$\mathbf{v} :]0, \infty[\times \mathbb{R} \rightarrow \mathbb{R}^2 \setminus \left\{ \begin{pmatrix} s \\ t \end{pmatrix} : s \leq 0, t = 0 \right\}$$

is bijective. In fact, the first equation of (4.12) implies $x = \sqrt{y^2 + s}$ since $x > 0$ (the solution $x = -\sqrt{y^2 + s}$ is in this case not allowable). By the second equation $2y\sqrt{y^2 + s} = t$, from which we obtain

$$4(y^2)^2 + 4sy^2 - t^2 = 0.$$

If $t = 0$, then $y = 0$ because $x = \sqrt{y^2 + s} > 0$, so $x = \sqrt{s}$. If $t \neq 0$ only the square root $y^2 = \frac{-s + \sqrt{s^2 + t^2}}{2} > 0$ is allowable (since $\frac{-s - \sqrt{s^2 + t^2}}{2} < 0$). The second equation of (4.12) implies that y and t have the same sign. We have found:

$$\mathbf{v}^{-1}(s, t) = \begin{pmatrix} x \\ y \end{pmatrix} = \begin{pmatrix} \sqrt{\frac{s + \sqrt{s^2 + t^2}}{2}} \\ \sqrt{\frac{-s + \sqrt{s^2 + t^2}}{2}} \end{pmatrix}$$

if $y > 0$,

$$\mathbf{v}^{-1}(s, t) = \begin{pmatrix} x \\ y \end{pmatrix} = \begin{pmatrix} \sqrt{\frac{s + \sqrt{s^2 + t^2}}{2}} \\ -\sqrt{\frac{-s + \sqrt{s^2 + t^2}}{2}} \end{pmatrix}$$

if $y < 0$ and if $t = 0$, then $s > 0$

$$\mathbf{v}^{-1}(s, 0) = \begin{pmatrix} x \\ 0 \end{pmatrix} = \begin{pmatrix} \sqrt{s} \\ 0 \end{pmatrix}.$$

This function represents the real and imaginary parts of the complex function $z = x + iy \mapsto z^2 = x^2 - y^2 + 2ixy$. We have constructed the real and imaginary part of $z \mapsto \sqrt{z}$ when $\operatorname{Re} z > 0$ (see Analysis 1, Chapter 1).

Examples - Calculation of inverse fields and Jacobian matrices . Let \mathbf{v} be a vector field of class C^1 and locally invertible at \mathbf{a} . To calculate the reverse field we have to resolve the system $\mathbf{y} = \mathbf{v}(\mathbf{x})$ for every \mathbf{x} in the neighborhood of \mathbf{a} (see example above). The theorem states that there exists a unique solution in the neighborhood of \mathbf{a} . We write $\mathbf{w}(\mathbf{y}) = \mathbf{v}^{-1}(\mathbf{y})$. We often only want to determine the Jacobian matrix of the reverse field (see the Chapter on multiple integrals). This can be done using the composition rule without determining the reverse field explicitly $\mathbf{v}^{-1}(\mathbf{y})$: the Jacobian matrix of the reverse field \mathbf{w} at the point $\mathbf{v}(\mathbf{a})$ is the inverse of the Jacobian matrix $J_{\mathbf{v}}(\mathbf{a})$.

1. We consider the function $\mathbf{v} :]0, \infty[\times \mathbb{R} \rightarrow \mathbb{R}^2$ given by

$$\mathbf{v}(r, \phi) = \begin{pmatrix} r \cos \phi \\ r \sin \phi \end{pmatrix}.$$

This function gives us the change of coordinates between the polar coordinate system and the Cartesian coordinate system if

$$\begin{aligned} x &= v_1(r, \phi) = r \cos \phi \\ y &= v_2(r, \phi) = r \sin \phi \end{aligned}$$

Its Jacobian matrix is

$$J_{\mathbf{v}}(r, \phi) = \begin{pmatrix} \cos \phi & -r \sin \phi \\ \sin \phi & r \cos \phi \end{pmatrix}$$

Its Jacobian determinant $\det J_{\mathbf{v}}(r, \phi) = r$ is non-zero if $r > 0$. Then $\mathbf{v}(r, \phi)$ is locally invertible at every point $(r, \phi) \in]0, \infty[\times \mathbb{R}$. The inverse matrix of $J_{\mathbf{v}}(r, \phi), (J_{\mathbf{v}}(r, \phi))^{-1}$ is given by

$$(J_{\mathbf{v}}(r, \phi))^{-1} = \frac{1}{r} \begin{pmatrix} r \cos \phi & r \sin \phi \\ -\sin \phi & \cos \phi \end{pmatrix}$$

Let $r > 0$. Using the relation $r = \sqrt{x^2 + y^2}$, $x/r = \cos \phi$ et $y/r = \sin \phi$ we obtain

$$(J_{\mathbf{v}}(r, \phi))^{-1} = \frac{1}{x^2 + y^2} \begin{pmatrix} x\sqrt{x^2 + y^2} & y\sqrt{x^2 + y^2} \\ -y & x \end{pmatrix} = J_{\mathbf{v}^{-1}}(x, y)$$

where \mathbf{v}^{-1} is the inverse function of \mathbf{v} . We can give an explicit representation of the inverse function (see Analysis 1, Chapter 1). Let $V = \{(r, \phi) : r > 0, \phi \in]-\pi, \pi[\}$ and $W = \mathbb{R}^2 \setminus (]-\infty, 0] \times \{0\})$. Then the function $\mathbf{v} : V \rightarrow W$ is bijective and its inverse function is given by

$$\mathbf{v}^{-1}(x, y) = \left(\begin{array}{c} \sqrt{x^2 + y^2} \\ 2 \arctan \frac{y}{x + \sqrt{x^2 + y^2}} \end{array} \right).$$

2. We consider the function $\mathbf{v} : \mathbb{R}^2 \rightarrow \mathbb{R}^2$ given by

$$\mathbf{v}(x, y) = \begin{pmatrix} e^y \\ x^2 \end{pmatrix}.$$

This function is locally invertible if $x > 0$ (or $x < 0$). Indeed,

$$J_{\mathbf{v}}(x, y) = \begin{pmatrix} 0 & e^y \\ 2x & 0 \end{pmatrix}$$

is invertible and

$$(J_{\mathbf{v}}(x, y))^{-1} = \begin{pmatrix} 0 & \frac{1}{2x} \\ e^{-y} & 0 \end{pmatrix}.$$

The explicit expression for the inverse function is

$$\mathbf{w}(v_1, v_2) = \begin{pmatrix} \sqrt{v_2} \\ \ln v_1 \end{pmatrix}.$$

3. We consider the function $\mathbf{v} : \mathbb{R}^2 \rightarrow]0, \infty[\times]0, \infty[$ given by

$$\mathbf{v}(x, y) = \begin{pmatrix} e^{x+y} \\ e^{x-y} \end{pmatrix}.$$

Its Jacobian matrix

$$J_{\mathbf{v}}(x, y) = \begin{pmatrix} e^{x+y} & e^{x+y} \\ e^{x-y} & -e^{x-y} \end{pmatrix}$$

is invertible and

$$(J_{\mathbf{v}}(x, y))^{-1} = \frac{1}{2e^{2x}} \begin{pmatrix} e^{x-y} & e^{x+y} \\ e^{x-y} & -e^{x+y} \end{pmatrix} = \frac{1}{2} \begin{pmatrix} e^{-(x+y)} & e^{-(x-y)} \\ e^{-(x+y)} & -e^{-(x-y)} \end{pmatrix} = \frac{1}{2} \begin{pmatrix} \frac{1}{v_1} & \frac{1}{v_2} \\ \frac{1}{v_1} & -\frac{1}{v_2} \end{pmatrix}.$$

Note that $v_1 v_2 = e^{2x}$ and $v_1 / v_2 = e^{2y}$ so

$$\mathbf{w}(v_1, v_2) = \frac{1}{2} \begin{pmatrix} \ln(v_1 v_2) \\ \ln\left(\frac{v_1}{v_2}\right) \end{pmatrix} = \begin{pmatrix} \ln v_1 + \ln v_2 \\ \ln v_1 - \ln v_2 \end{pmatrix}.$$

4. Change of coordinate system between the spherical coordinate system and the Cartesian coordinates system in \mathbb{R}^3 : We consider the function

$$\begin{aligned} x &= v_1(r, \theta, \phi) = r \sin \theta \cos \phi \\ y &= v_2(r, \theta, \phi) = r \sin \theta \sin \phi \\ z &= v_3(r, \theta, \phi) = r \cos \theta \end{aligned}$$

Its Jacobian matrix is

$$J_{\mathbf{v}}(r, \phi, \theta) = \begin{pmatrix} \sin \theta \cos \phi & r \cos \theta \cos \phi & -r \sin \theta \sin \phi \\ \sin \theta \sin \phi & r \cos \theta \sin \phi & r \sin \theta \cos \phi \\ \cos \theta & -r \sin \theta & 0 \end{pmatrix}$$

Therefore,

$$\begin{aligned} \det J_{\mathbf{v}}(r, \theta, \phi) &= r \cos \theta \cos \phi r \sin \theta \cos \phi \cos \theta \\ &\quad + r \sin \theta \sin \phi \sin \theta \sin \phi r \sin \theta \\ &\quad + r \sin \theta \sin \phi r \cos \theta \sin \phi \cos \theta \\ &\quad + \sin \theta \cos \phi r \sin \theta \cos \phi r \sin \theta \\ &= r^2 \sin \theta (\cos^2 \phi \cos^2 \theta + \sin^2 \phi \sin^2 \theta \\ &\quad + \cos^2 \phi \sin^2 \theta + \cos^2 \phi \sin^2 \theta) \\ &= r^2 \sin \theta \end{aligned}$$

When $x > 0, y > 0, z > 0$ the inverse function is given by

$$\begin{aligned} r &= w_1(x, y, z) = \sqrt{x^2 + y^2 + z^2} \\ \phi &= w_2(x, y, z) = \arcsin \frac{y}{\sqrt{x^2 + y^2}} \\ \theta &= w_3(x, y, z) = \arccos \frac{z}{\sqrt{x^2 + y^2 + z^2}} \end{aligned}$$

4.2.3 Transformations of the Gradient and the Laplacian

Transformation of the Gradient in 2 dimensions. Let $U, V \subset \mathbb{R}^2$ and $\mathbf{v} : U \rightarrow V$ an invertible function of class $C^1(U)$ defined as

$$\mathbf{v}(s, t) = (x, y).$$

Let $f : \mathbb{R}^2 \rightarrow \mathbb{R}$ be a real valued function of class C^1 . Let us define $g(s, t) = f(x, y) = f(\mathbf{v}(s, t))$ and reciprocally $f(x, y) = g(\mathbf{v}^{-1}(x, y))$. We calculate the Jacobian matrices of $\mathbf{v}(s, t)$ and $\mathbf{v}^{-1}(x, y)$ as

$$J_{\mathbf{v}}(s, t) = \begin{pmatrix} D_s x & D_t x \\ D_s y & D_t y \end{pmatrix}, \quad \text{respectively} \quad J_{\mathbf{v}^{-1}}(x, y) = \begin{pmatrix} D_x s & D_y s \\ D_x t & D_y t \end{pmatrix}$$

Using the composition rule we have

$$\begin{aligned} \nabla_{x,y} g(s, t) &= \begin{pmatrix} \frac{\partial s}{\partial x} \frac{\partial g(s,t)}{\partial s} + \frac{\partial t}{\partial x} \frac{\partial g(s,t)}{\partial t} \\ \frac{\partial s}{\partial y} \frac{\partial g(s,t)}{\partial s} + \frac{\partial t}{\partial y} \frac{\partial g(s,t)}{\partial t} \end{pmatrix} \\ &= (J_{\mathbf{v}^{-1}}(x, y))^T \nabla_{s,t} g(s, t) \\ &= (J_{\mathbf{v}^{-1}}(\mathbf{v}(s, t)))^T \nabla_{s,t} g(s, t). \end{aligned}$$

Consequently,

$$\begin{aligned} \|\nabla_{x,y} g(s, t)\|_2^2 &= \|(J_{\mathbf{v}^{-1}}(\mathbf{v}(s, t)))^T \nabla_{s,t} g(s, t)\|_2^2 \\ &= \nabla_{s,t} g(s, t)^T J_{\mathbf{v}^{-1}}(\mathbf{v}(s, t)) \cdot (J_{\mathbf{v}^{-1}}(\mathbf{v}(s, t)))^T \nabla_{s,t} g(s, t), \end{aligned}$$

where

$$J_{\mathbf{v}^{-1}}(\mathbf{v}(s, t)) \cdot (J_{\mathbf{v}^{-1}}(\mathbf{v}(s, t)))^T = \begin{pmatrix} \|\nabla_{x,y} s\|_2^2 & \langle \nabla_{x,y} s, \nabla_{x,y} t \rangle \\ \langle \nabla_{x,y} s, \nabla_{x,y} t \rangle & \|\nabla_{x,y} t\|_2^2 \end{pmatrix}$$

is the metric tensor of the coordinates (s, t) .

Examples - polar coordinates. Let $V = \{(r, \phi) : r > 0, \phi \in]-\pi, \pi[\}$ and $W = \mathbb{R}^2 \setminus (]-\infty, 0] \times \{0\})$. Consider the bijective mapping $\mathbf{v} : V \rightarrow W$ defined as

$$\begin{pmatrix} x \\ y \end{pmatrix} = \mathbf{v}(r, \phi) = \begin{pmatrix} r \cos \phi \\ r \sin \phi \end{pmatrix}.$$

Recall that its Jacobian matrix is

$$J_{\mathbf{v}}(r, \phi) = \begin{pmatrix} \cos \phi & -r \sin \phi \\ \sin \phi & r \cos \phi \end{pmatrix}$$

and that the inverse of $J_{\mathbf{v}}(r, \phi), (J_{\mathbf{v}}(r, \phi))^{-1}$ is given as

$$\begin{aligned} (J_{\mathbf{v}}(r, \phi))^{-1} &= \frac{1}{r} \begin{pmatrix} r \cos \phi & r \sin \phi \\ -\sin \phi & \cos \phi \end{pmatrix} \\ &= \frac{1}{x^2 + y^2} \begin{pmatrix} x\sqrt{x^2 + y^2} & y\sqrt{x^2 + y^2} \\ -y & x \end{pmatrix} = J_{\mathbf{v}^{-1}}(x, y) \end{aligned}$$

It follows that

$$D_x g(r, \phi) = \cos \phi D_r g(r, \phi) - \frac{\sin \phi}{r} D_\phi g(r, \phi)$$

$$D_y g(r, \phi) = \sin \phi D_r g(r, \phi) + \frac{\cos \phi}{r} D_\phi g(r, \phi)$$

and

$$(D_x g(r, \phi))^2 + (D_y g(r, \phi))^2 = (D_r g(r, \phi))^2 + \frac{1}{r^2} (D_\phi g(r, \phi))^2.$$

The transformation formulas for partial derivatives

$$\frac{\partial g(r, \phi)}{\partial x} = \frac{\partial r}{\partial x} \frac{\partial g(r, \phi)}{\partial r} + \frac{\partial \phi}{\partial x} \frac{\partial g(r, \phi)}{\partial \phi}$$

and

$$\frac{\partial g(r, \phi)}{\partial y} = \frac{\partial r}{\partial y} \frac{\partial g(r, \phi)}{\partial r} + \frac{\partial \phi}{\partial y} \frac{\partial g(r, \phi)}{\partial \phi}.$$

are calculated in a very intuitive way: the partial derivative with respect to the variable x (respectively y) of a function $g(r, \phi)$ is calculated by summing the partial derivatives with respect to x (resp. y) of the coordinates (r, ϕ) multiplied by the partial derivative of $g(r, \phi)$ with respect to coordinates (r, ϕ) . Note as well that

$$(D_x g(r, \phi))^2 + (D_y g(r, \phi))^2 = (D_r g(r, \phi))^2 + \frac{1}{r^2} (D_\phi g(r, \phi))^2.$$

Transformation of the Gradient. Let $U \subset \mathbb{R}^n$ and $\mathbf{v} : U \rightarrow \mathbb{R}^n$ be an invertible mapping of class $C^1(U)$. Set

$$\mathbf{x} = \mathbf{v}(\mathbf{s}).$$

We write $\mathbf{x}(\mathbf{s})$ and $\mathbf{s}(\mathbf{x})$ for the reverse mapping $v^{-1}(\mathbf{x})$. Let $g : U \rightarrow \mathbb{R}$ be a function of class $C^1(U)$ of the coordinates \mathbf{s} and set $f(\mathbf{x}) = g(\mathbf{s})$, that is to say, $f = g \circ \mathbf{s}$. Then

$$J_f(\mathbf{x}) = J_g(\mathbf{s})J_{\mathbf{s}}(\mathbf{x})$$

and

$$J_f(\mathbf{x})J_f(\mathbf{x})^T = J_g(\mathbf{s})J_s(\mathbf{x})J_s^T(\mathbf{x})\nabla_s g(\mathbf{s}).$$

The elements of the metric tensor $J_s(\mathbf{x})J_s^T(\mathbf{x})$ are given as

$$(J_s(\mathbf{x})J_s^T(\mathbf{x}))_{ij} = \langle \nabla_{\mathbf{x}} s_i, \nabla_{\mathbf{x}} s_j \rangle.$$

Transformation of the Laplacian. Let $U \subset \mathbb{R}^n$ and $\mathbf{v}: U \rightarrow \mathbb{R}^n$ be an invertible mapping of class $C^2(U)$. We set

$$\mathbf{x} = \mathbf{v}(\mathbf{s}).$$

For a function $g: U \rightarrow \mathbb{R}$ of class $C^2(U)$, defined as a function of the coordinates \mathbf{s} , we seek to calculate

$$\Delta_{\mathbf{x}} g(\mathbf{s}) = \sum_{i=1}^n D_{x_i x_i} g(\mathbf{s})$$

As above we calculate

$$\frac{\partial g(\mathbf{s})}{\partial x_i} = \sum_{j=1}^n \frac{\partial s_j}{\partial x_i} \frac{\partial g(\mathbf{s})}{\partial s_j}$$

and

$$\begin{aligned} \frac{\partial^2 g(\mathbf{s})}{\partial x_i^2} &= \sum_{j=1}^n \frac{\partial^2 s_j}{\partial x_i^2} \frac{\partial g(\mathbf{s})}{\partial s_j} \\ &+ \sum_{j=1}^n \frac{\partial s_j}{\partial x_i} \sum_{k=1}^n \frac{\partial s_k}{\partial x_i} \frac{\partial^2 g(\mathbf{s})}{\partial s_j \partial s_k} \end{aligned}$$

Therefore

$$\begin{aligned} \Delta_{\mathbf{x}} g(\mathbf{s}) &= \sum_{j=1}^n \Delta_{\mathbf{x}} s_j \frac{\partial g(\mathbf{s})}{\partial s_j} \\ &+ \sum_{j=1}^n \sum_{k=1}^n \langle \nabla_{\mathbf{x}} s_j, \nabla_{\mathbf{x}} s_k \rangle \frac{\partial^2 g(\mathbf{s})}{\partial s_j \partial s_k} \end{aligned}$$

Example - polar coordinates. Given $V = \{(r, \phi) : r > 0, \phi \in]-\pi, \pi[\}$ and $W = \mathbb{R}^2 \setminus (]-\infty, 0] \times \{0\})$. We consider the bijective mapping $\mathbf{v}: V \rightarrow W$ given by

$$\mathbf{v}(r, \phi) = (x, y) = (r \cos \phi, r \sin \phi).$$

and $f: \mathbb{R}^2 \rightarrow \mathbb{R}$ a real valued function of class C^1 . We set $g(r, \phi) = f(x, y) = f(\mathbf{v}(r, \phi))$. We calculate the Laplacian of g directly

$$\frac{\partial g(r, \phi)}{\partial x} = \frac{\partial r}{\partial x} \frac{\partial g(r, \phi)}{\partial r} + \frac{\partial \phi}{\partial x} \frac{\partial g(r, \phi)}{\partial \phi}$$

and

$$\begin{aligned} \frac{\partial^2 g(r, \phi)}{\partial x^2} &= \frac{\partial^2 r}{\partial x^2} \frac{\partial g(r, \phi)}{\partial r} + \left(\frac{\partial r}{\partial x} \right)^2 \frac{\partial^2 g(r, \phi)}{\partial r^2} + \frac{\partial r}{\partial x} \frac{\partial \phi}{\partial x} \frac{\partial^2 g(r, \phi)}{\partial \phi \partial r} \\ &+ \frac{\partial^2 \phi}{\partial x^2} \frac{\partial g(r, \phi)}{\partial \phi} + \left(\frac{\partial \phi}{\partial x} \right)^2 \frac{\partial^2 g(r, \phi)}{\partial \phi^2} + \frac{\partial r}{\partial x} \frac{\partial \phi}{\partial x} \frac{\partial^2 g(r, \phi)}{\partial \phi \partial r}. \end{aligned}$$

Therefore

$$\begin{aligned}\Delta_{x,y}g(r, \phi) &= \Delta_{x,y}r \frac{\partial g(r, \phi)}{\partial r} + \|\nabla_{x,y}r\|_2^2 \frac{\partial^2 g(r, \phi)}{\partial r^2} \\ &\quad + \Delta_{x,y}\phi \frac{\partial g(r, \phi)}{\partial \phi} + \|\nabla_{x,y}\phi\|_2^2 \frac{\partial^2 g(r, \phi)}{\partial \phi^2} \\ &\quad + 2\langle \nabla_{x,y}r, \nabla_{x,y}\phi \rangle \frac{\partial^2 g(r, \phi)}{\partial \phi \partial r}\end{aligned}$$

Using the Jacobian matrix we observe that

$$\|\nabla_{x,y}r\|_2^2 = 1, \quad \|\nabla_{x,y}\phi\|_2^2 = \frac{1}{r^2}, \quad \langle \nabla_{x,y}r, \nabla_{x,y}\phi \rangle = 0$$

in addition

$$\Delta_{x,y}r = \frac{d^2 r}{dr^2} + \frac{1}{r} \frac{dr}{dr} = \frac{1}{r}$$

and

$$\Delta_{x,y}\phi = -\frac{\partial}{\partial x} \frac{y}{r^2} + \frac{\partial}{\partial y} \frac{x}{r^2} = 0.$$

Consequently,

$$\Delta_{x,y}g(r, \phi) = \frac{\partial^2 g(r, \phi)}{\partial r^2} + \frac{1}{r} \frac{\partial g(r, \phi)}{\partial r} + \frac{1}{r^2} \frac{\partial^2 g(r, \phi)}{\partial \phi^2}.$$

4.3 Implicit functions

introduction. Let $U \subset \mathbb{R}^2$ be open and $f : U \rightarrow \mathbb{R}$ be a function of class $C^1(U)$. For $C \in \mathbb{R}$ consider the level set of f :

$$N_f(c) = \{(x, y) \in \mathbb{R}^2 : f(x, y) = c\}$$

To understand the form of $N_f(c)$ we can seek to solve the equation $f(x, y) = c$ for y as a function of x (or for x as a function of y). In the first case, $N_f(c)$ can be represented as the graph of a real valued function $g(x)$ and $y = g(x)$ is its equation.

Example. Let $f : \mathbb{R}^2 \rightarrow \mathbb{R}$ be defined as

$$f(x, y) = x^2 + e^y - 1.$$

To determine the form of $N_f(0)$ we try to solve the equation $x^2 + e^y - 1 = 0$ for y as a function of x . A solution exists only for $-1 \leq x \leq 1$ and we find that

$$y = \ln(1 - x^2).$$

Therefore $N_f(0)$ is given by the graph of the function

$$g(x) = \ln(1 - x^2).$$

The function g is differentiable at all $x \in]-1, +1[$ and satisfies the equation

$$x^2 + e^{g(x)} - 1 = 0.$$

We can use this equation to calculate the derivative of $g(x)$. This technique is called implicit differentiation. By computing the derivative with respect to x , we get

$$2x + g'(x)e^{g(x)} = 0$$

i.e.

$$g'(x) = -2xe^{-g(x)} = -\frac{2x}{1 - x^2}$$

Note that $D_1f(x, y) = 2x$ and $D_2f(x, y) = e^y$. Hence,

$$g'(x) = -\frac{D_1f(x, g(x))}{D_2f(x, g(x))}.$$

This relation is verified in the general case:

Implicit function theorem. Let $U \subset \mathbb{R}^2$ be open and $f : U \rightarrow \mathbb{R}$ be a function of class $C^k(U)$, $k \geq 1$, such that $f(a, b) = 0$ for a point $(a, b) \in U$ and $D_2f(a, b) \neq 0$. Then there exists a neighborhood $B_\epsilon(a)$ and a unique function $g : B_\epsilon(a) \rightarrow \mathbb{R}$ such that

1. The graph of g is in U : $G_g = \{(x, g(x)) : x \in B_\epsilon(a)\} \subset U$.
2. $g(a) = b$
3. $f(x, g(x)) = 0$ for every $x \in B_\epsilon(a)$.

4. The function g is of class $C^k(B_\epsilon(a))$ and

$$g'(x) = -\frac{D_1 f(x, g(x))}{D_2 f(x, g(x))}$$

for every $x \in B_\epsilon(a)$. In particular,

$$g'(a) = -\frac{D_1 f(a, b)}{D_2 f(a, b)}.$$

Remark. The theorem states that when close to the point $(a, b) \in \mathbb{R}^2$, we can solve the equation $f(x, y) = 0$ (or more generally $f(x, y) = c$ for a $c \in \mathbb{R}$) by rewriting y as a function of the variable x . In other words, the function $y = g(x)$ is given implicitly by the equation

$$f(x, g(x)) = 0.$$

In a neighborhood of the point $(a, b) \in \mathbb{R}^2$, the level set $N_f(0)$ is given by the graph of g .

Remark. The relation

$$g'(x) = -\frac{D_1 f(x, g(x))}{D_2 f(x, g(x))} \quad (4.13)$$

is verified in the neighborhood of a since the continuity of the derivatives implies the existence of a neighborhood of (a, b) such that $D_2 f(x, y) \neq 0$.

Proof. We define a mapping $\mathbf{v} : U \rightarrow \mathbb{R}^2$ of class C^1 by

$$\mathbf{v}(x, y) = \begin{pmatrix} s \\ t \end{pmatrix} := \begin{pmatrix} x \\ f(x, y) \end{pmatrix}$$

Its Jacobian matrix is given by

$$J_{\mathbf{v}}(x, y) = \begin{pmatrix} \frac{\partial s}{\partial x} & \frac{\partial s}{\partial y} \\ \frac{\partial t}{\partial x} & \frac{\partial t}{\partial y} \end{pmatrix} = \begin{pmatrix} 1 & 0 \\ \frac{\partial f(x, y)}{\partial x} & \frac{\partial f(x, y)}{\partial y} \end{pmatrix}.$$

The Jacobian determinant is $\det J_{\mathbf{v}}(x, y) = \frac{\partial f(x, y)}{\partial y}$. At (a, b) :

$$\mathbf{v}(a, b) = \begin{pmatrix} a \\ 0 \end{pmatrix}, \quad \det J_{\mathbf{v}}(a, b) = D_2 f(a, b) \neq 0.$$

Consequently, \mathbf{v} is invertible in a neighborhood of (a, b) and the reverse mapping is given by:

$$\begin{pmatrix} x \\ y \end{pmatrix} = \begin{pmatrix} x(s, t) \\ y(s, t) \end{pmatrix} = \begin{pmatrix} s \\ y(s, t) \end{pmatrix}.$$

Set $g(s) := y(s, 0)$. By construction, g is of class C^1 and its graph is in U . We have $g(a) = b$ and

$$\begin{pmatrix} s \\ 0 \end{pmatrix} = \mathbf{v}(x(s, 0), y(s, 0)) = \begin{pmatrix} s \\ f(s, g(s)) \end{pmatrix}$$

therefore $0 = f(s, g(s))$. Formula (4.13) for $g'(x)$ follows the composition rule. If f is of class C^k with $k > 1$, the right-hand side of the equation (4.13) is of class C^1 so g' is of class C^1 and therefore g is of class C^2 . We establish an identity for $g''(x)$ etc. (Equation (4.14) below) going up to order k .

Example. The equation $x \sin x - e^y \sin y = 0$ has a unique solution $y = g(x)$ of class C^1 (even C^∞) in the neighborhood of $(x, y) = (0, 0)$. Actually, $f(x, y) = x \sin x - e^y \sin y$ satisfies all the hypotheses of the implicit function theorem. In particular, $f(0, 0) = 0$ and $D_2 f(0, 0) = -1$.

Generalization of the implicit function theorem. Let $U \subset \mathbb{R}^n$ be open and $f : U \rightarrow \mathbb{R}$ a function of class $C^k(U)$, $k \geq 1$, such that $f(a_1, \dots, a_{n-1}, a_n) = 0$ for a point $(a_1, \dots, a_{n-1}, a_n) \in U$ and $D_n f(a_1, \dots, a_{n-1}, a_n) \neq 0$. Then there exists neighborhood $B_\epsilon(a) \subset \mathbb{R}^{n-1}$ and a unique function $g : B_\epsilon(a_1, \dots, a_{n-1}) \rightarrow \mathbb{R}$ such that

1. The graph of g is in U : $G_g = \{(x_1, \dots, x_{n-1}, g(x_1, \dots, x_{n-1})) : x \in B_\epsilon(a_1, \dots, a_{n-1})\} \subset U$.
2. $g(a_1, \dots, a_{n-1}) = a_n$
3. $f((x_1, \dots, x_{n-1}, g(x_1, \dots, x_{n-1}))) = 0$ for all $(x_1, \dots, x_{n-1}) \in B_\epsilon(a_1, \dots, a_{n-1})$.
4. The function g is of class $C^k(B_\epsilon(a_1, \dots, a_{n-1}))$ and

$$D_i g(x_1, \dots, x_{n-1}) = - \frac{D_i f(x_1, \dots, x_{n-1}, g(x_1, \dots, x_{n-1}))}{D_n f(x_1, \dots, x_{n-1}, g(x_1, \dots, x_{n-1}))}$$

for every $x \in B_\epsilon(a)$.

Example. Show that close to the point $(1, 2, 3)$,

$$6x^4 + xyz + y^4 - y^2 z^2 + 8 = 0$$

is a surface in \mathbb{R}^3 . Find the equations of the tangent plane to this surface at the point $(1, 2, 3)$. We set

$$f(x, y, z) = 6x^4 + xyz + y^4 - y^2 z^2 + 8.$$

The function f is of class $C^1(\mathbb{R}^3)$ (and even of class $C^k(\mathbb{R}^3)$ for any $k \in \mathbb{N}$) and its partial derivatives are

$$D_1 f(x, y, z) = 24x^3 + yz, \quad D_2 f(x, y, z) = xz + 4y^3 - 2yz^2, \quad D_3 f(x, y, z) = xy - 2y^2 z$$

we have $f(1, 2, 3) = 0$ and $D_3 f(1, 2, 3) = -22 \neq 0$. Therefore there exists a unique function $g(x, y)$ defined in the neighborhood of $(1, 2)$ such that

$$g(1, 2) = 3, \quad f(x, y, g(x, y)) = 0.$$

The equation of the tangent plane is given by

$$z = g(1, 2) + \langle \nabla g(1, 2), \begin{pmatrix} x - 1 \\ y - 2 \end{pmatrix} \rangle$$

with

$$D_1 g(1, 2) = - \frac{D_1 f(1, 2, g(1, 2))}{D_3 f(1, 2, g(1, 2))} = - \frac{D_1 f(1, 2, 3)}{D_3 f(1, 2, 3)}$$

and

$$D_2 g(1, 2) = - \frac{D_2 f(1, 2, g(1, 2))}{D_3 f(1, 2, g(1, 2))} = - \frac{D_2 f(1, 2, 3)}{D_3 f(1, 2, 3)}$$

we obtain that

$$(z - 3)D_3f(1, 2, 3) = -D_1f(1, 2, 3)(x - 1) - D_2f(1, 2, 3)(y - 2)$$

i.e.

$$0 = D_1f(1, 2, 3)(x-1) + D_2f(1, 2, 3)(y-2) + (z-3)D_3f(1, 2, 3) = \langle \nabla f(1, 2, 3), \begin{pmatrix} x-1 \\ y-2 \\ z-3 \end{pmatrix} \rangle$$

This equation confirms the geometric intuition that the gradient of f is orthogonal to the tangent plane of the surface $N_f(0)$. Therefore

$$z = \frac{19}{11} + \frac{15x}{11} - \frac{y}{22}$$

is the equation of the tangent plane.

Example. If $D_2f(a, b) = 0$ the function $g(x)$ may exist but it is not necessarily unique. Let $f : \mathbb{R}^2 \rightarrow \mathbb{R}$ be defined as

$$f(x, y) = x^2 + y^4 - 1.$$

Let $(a, b) = (1, 0)$. The equation $x^2 + y^4 - 1 = 0$ for y as a function of x has two solutions for $-1 \leq x \leq 1$ and we find

$$y = \begin{cases} \sqrt[4]{1-x^2} & \text{if } y \geq 0, \\ -\sqrt[4]{1-x^2} & \text{if } y < 0. \end{cases}$$

In addition, the function

$$g(x) = \sqrt[4]{1-x^2}$$

is not differentiable at $x = 1$. However, for the point $(a, b) = (0, 1)$ the implicit function theorem can be used and gives the unique function

$$g(x) = \sqrt[4]{1-x^2}$$

differentiable in the neighborhood of a and can be extended for any $x \in]-1, +1[$ and is differentiable on this interval with derivative

$$g'(x) = -\frac{D_1f(x, g(x))}{D_2f(x, g(x))} = -\frac{x}{2\sqrt[4]{(1-x^2)^3}}.$$

Derivatives of higher order. Consider the implicit function theorem for $U \subset \mathbb{R}^2$ an open set and a function $f : U \rightarrow \mathbb{R}$ of class $C^k(U)$, $k \geq 2$. If the hypotheses of the theorem are satisfied, then there exists a function $g(x)$ such that $f(x, g(x)) = 0$. The derivative of $g(x)$ verifies the equation

$$D_1f(x, g(x)) + g'(x)D_2f(x, g(x)) = 0$$

Let us take the derivative of this identity, we obtain

$$D_{11}f(x, g(x)) + 2g'(x)D_{12}f(x, g(x)) + g''(x)D_2f(x, g(x)) + g'(x)^2D_{22}f(x, g(x)) = 0$$

i.e.

$$g''(x) = - \frac{D_{11}f(x, g(x)) + 2g'(x)D_{12}f(x, g(x)) + g'(x)^2 D_{22}f(x, g(x))}{D_2f(x, g(x))}. \quad (4.14)$$

In particular, if $g'(a) = 0$ (horizontal tangent at a), then

$$g''(a) = - \frac{D_{11}f(a, g(a))}{D_2f(a, g(a))} = - \frac{D_{11}f(a, b)}{D_2f(a, b)}.$$

We can then calculate the successive derivatives of the implicit function $g(x)$ at a without determining $g(x)$ and we can therefore calculate its linear approximation at $x = a$.

4.3.1 Implicit differentiation

The technique we used above to compute the derivative of a function is called implicit differentiation. It can for example be applied to variable substitution to calculate the partial derivatives without explicitly reversing the substitution.

Example - polar coordinates. Given $V = \{(r, \phi) : r > 0, \phi \in]-\pi, \pi[\}$ and $W = \mathbb{R}^2 \setminus (]-\infty, 0] \times \{0\})$. Consider the bijective mapping $\mathbf{v} : V \rightarrow W$ defined as

$$\mathbf{v}(r, \phi) = (x, y) = (r \cos \phi, r \sin \phi).$$

We will calculate the partial derivatives $\frac{\partial r}{\partial x}, \frac{\partial r}{\partial y}, \frac{\partial \phi}{\partial x}, \frac{\partial \phi}{\partial y}$ with the implicit differentiation technique using the partial derivatives with respect to the variable x and y in the equations of the substitution $x = r \cos \phi$ et $y = r \sin \phi$. We obtain four linear equations with the four partial derivatives we want to determine:

$$\begin{aligned} 1 &= \cos \phi \frac{\partial r}{\partial x} - r \sin \phi \frac{\partial \phi}{\partial x} \\ 0 &= \cos \phi \frac{\partial r}{\partial y} - r \sin \phi \frac{\partial \phi}{\partial y} \\ 0 &= \sin \phi \frac{\partial r}{\partial x} + r \cos \phi \frac{\partial \phi}{\partial x} \\ 1 &= \sin \phi \frac{\partial r}{\partial y} + r \cos \phi \frac{\partial \phi}{\partial y}. \end{aligned}$$

This yields

$$\frac{\partial r}{\partial x} = \cos \phi, \quad \frac{\partial r}{\partial y} = \sin \phi, \quad \frac{\partial \phi}{\partial x} = \frac{-\sin \phi}{r}, \quad \frac{\partial \phi}{\partial y} = \frac{\cos \phi}{r}.$$

4.4 Addendum - a few formulas

Let $f, g : \mathbb{R}^n \rightarrow \mathbb{R}$, and $\mathbf{u}, \mathbf{v}, \mathbf{w} : \mathbb{R}^n \rightarrow \mathbb{R}^n$ smooth enough.

$$\nabla(fg) = f\nabla g + g\nabla f, \quad (4.15)$$

$$\operatorname{div}(f\mathbf{u}) = \langle \nabla f, \mathbf{u} \rangle + f \operatorname{div} \mathbf{u}, \quad (4.16)$$

$$\operatorname{div}(\mathbf{v} \times \mathbf{w}) = \langle \mathbf{w}, \nabla \times \mathbf{v} \rangle - \langle \mathbf{v}, \nabla \times \mathbf{w} \rangle, (n = 3) \quad (4.17)$$

$$\nabla \times (f\mathbf{u}) = \nabla f \times \mathbf{u} + f\nabla \times \mathbf{u}, (n = 2, 3). \quad (4.18)$$

$$\Delta(fg) = f\Delta g + 2\langle \nabla f, \nabla g \rangle + g\Delta f, \quad (4.19)$$

$$\Delta \ln(f^2) = 2 \frac{f\Delta f - \langle \nabla f, \nabla f \rangle}{f^2}, f \neq 0. \quad (4.20)$$

$$\langle \mathbf{v}, \nabla \rangle \mathbf{w} = J_{\mathbf{w}} \cdot \mathbf{v}, \quad (4.21)$$

$$\nabla(\langle \mathbf{v}, \mathbf{w} \rangle) = J_{\mathbf{v}}^T \cdot \mathbf{w} + J_{\mathbf{w}}^T \cdot \mathbf{v}. \quad (4.22)$$

$$\nabla \times \nabla f = 0 \quad (4.23)$$

$$\operatorname{div}(\nabla \times f) = 0 \quad (4.24)$$

Chapter 5

Local extrema

As in the case of single variable functions, it is important for many applications to determine the local extrema of a function $f : \mathbb{R}^n \rightarrow \mathbb{R}$.

5.1 Extrema and stationary points

Definition - Local extremum. A function $f : \mathbb{R}^n \rightarrow \mathbb{R}$ reaches a local maximum at $\mathbf{a} \in \mathbb{R}^n$ if there exists a ball $B_\delta(\mathbf{a})$ such that $f(\mathbf{x}) \leq f(\mathbf{a})$ for any $\mathbf{x} \in B_\delta(\mathbf{a})$. The maximum is called a strict maximum if $f(\mathbf{x}) < f(\mathbf{a})$ for $\mathbf{x} \neq \mathbf{a}$. A function $f : \mathbb{R}^n \rightarrow \mathbb{R}$ reaches a local minimum at $\mathbf{a} \in \mathbb{R}^n$ if there exists a ball $B_\delta(\mathbf{a})$ such that $f(\mathbf{x}) \geq f(\mathbf{a})$ for any $\mathbf{x} \in B_\delta(\mathbf{a})$. The minimum is called a strict minimum if $f(\mathbf{x}) > f(\mathbf{a})$ for $\mathbf{x} \neq \mathbf{a}$. We say that f has a local extremum at $\mathbf{a} \in \mathbb{R}^n$ if f has a local maximum or a local minimum at $\mathbf{a} \in \mathbb{R}^n$.

Definition - Stationary point. Let $f : \mathbb{R}^n \rightarrow \mathbb{R}$ be differentiable at $\mathbf{a} \in \mathbb{R}^n$ with $\nabla f(\mathbf{a}) = \mathbf{0}$, \mathbf{a} is called a stationary point or a critical point of f .

Definition - Saddle point. A stationary point $\mathbf{a} \in \mathbb{R}^n$ is called a saddle point of f if there exists two vectors $\mathbf{v}_1, \mathbf{v}_2 \in \mathbb{R}^n$ such that the function $t \mapsto f(\mathbf{a} + t\mathbf{v}_1)$ has a strict local maximum at $t = 0$ and $t \mapsto f(\mathbf{a} + t\mathbf{v}_2)$ has a strict local minimum at $t = 0$.

Theorem 5.1. - necessary condition for local extrema. Let $f : \mathbb{R}^n \rightarrow \mathbb{R}$ be differentiable at $\mathbf{a} \in \mathbb{R}^n$. If f has a local extremum at \mathbf{a} then \mathbf{a} is a stationary point of f , that is to say $\nabla f(\mathbf{a}) = \mathbf{0}$.

Proof. Without loss of generality we can suppose that f has a local maximum at \mathbf{a} . Let $B_\delta(\mathbf{a})$ be such that $f(\mathbf{x}) \leq f(\mathbf{a})$ for any $\mathbf{x} \in B_\delta(\mathbf{a})$. Then for any $\mathbf{a} + \mathbf{h} \in B_\delta(\mathbf{a})$ the function $g : [-1, 1] \rightarrow \mathbb{R}$ defined as $g(t) = f(\mathbf{a} + t\mathbf{h})$ is differentiable at $t = 0$ and has a local maximum at $t=0$, hence

$$g'(0) = \langle \nabla f(\mathbf{a}), \mathbf{h} \rangle = 0.$$

for any $\mathbf{h} \in B_\delta(\mathbf{0})$ and therefore $\nabla f(\mathbf{a}) = \mathbf{0}$. □

5.2 Quadratic forms

Let $A \in M_{n,n}(\mathbb{R})$ be a symmetric matrix and $q : \mathbb{R}^n \rightarrow \mathbb{R}$ a quadratic form defined as

$$q(\mathbf{x}) = \frac{1}{2} \langle A\mathbf{x}, \mathbf{x} \rangle.$$

The function $q(\mathbf{x})$ is of class C^2 with

$$\nabla q(\mathbf{x}) = \sum_{k=1}^n \langle A\mathbf{x}, \mathbf{e}_k \rangle \mathbf{e}_k = A\mathbf{x}$$

and

$$\text{Hess}(q)(\mathbf{x}) = A.$$

For any $\mathbf{x}, \mathbf{a} \in \mathbb{R}^n$ the quadratic form can be represented as

$$q(\mathbf{x}) = q(\mathbf{a}) + \langle \nabla q(\mathbf{a}), \mathbf{x} - \mathbf{a} \rangle + \frac{1}{2} \langle \text{Hess}(q)(\mathbf{a})(\mathbf{x} - \mathbf{a}), \mathbf{x} - \mathbf{a} \rangle.$$

In particular, if \mathbf{a} is a stationary point of $q(\mathbf{x})$, i.e. $A\mathbf{a} = 0$, then

$$q(\mathbf{x}) = q(\mathbf{a}) + \frac{1}{2} \langle \text{Hess}(q)(\mathbf{a})(\mathbf{x} - \mathbf{a}), \mathbf{x} - \mathbf{a} \rangle.$$

The equation $A\mathbf{a} = 0$ implies that the point $\mathbf{a} = \mathbf{0}$ is always a stationary point. The quadratic form $q(\mathbf{x})$ has stationary points $\mathbf{a} \neq \mathbf{0}$ if and only if 0 is an eigenvalue of the matrix A . To study the nature of stationary points we introduce the following definition.

Definition. Let $A \in M_{n,n}(\mathbb{R})$ be a symmetric matrix. A is said to be positive-semidefinite (respectively positive-definite) if the quadratic form

$$q(\mathbf{x}) = \frac{1}{2} \langle A\mathbf{x}, \mathbf{x} \rangle$$

associated with it satisfies $q(\mathbf{x}) \geq 0$ (respectively $q(\mathbf{x}) > 0$) for any $\mathbf{x} \neq \mathbf{0}$. A is said to be negative-semidefinite (respectively negative-definite) if $q(\mathbf{x}) \leq 0$ (respectively $q(\mathbf{x}) < 0$) for any $\mathbf{x} \neq \mathbf{0}$. The matrix A is said to be indefinite if A is neither negative-semidefinite nor positive-semidefinite.

Link with the eigenvalues. For any symmetric matrix $A \in M_{n,n}(\mathbb{R})$ there exists an orthogonal matrix P such that $P^{-1}AP = D$ where D is the diagonal matrix

$$D = \text{diag}(\lambda_1, \dots, \lambda_n) = \sum_{i=1}^n \lambda_i E_{ii} \quad \text{and} \quad \lambda_1 \leq \dots \leq \lambda_n.$$

$\lambda_1, \dots, \lambda_n$ are the eigenvalues of A . We have the following equivalences:

$$\begin{aligned} A \geq 0 &\Leftrightarrow 0 \leq \lambda_1 \leq \dots \leq \lambda_n \\ A > 0 &\Leftrightarrow 0 < \lambda_1 \leq \dots \leq \lambda_n \\ A \leq 0 &\Leftrightarrow \lambda_1 \leq \dots \leq \lambda_n \leq 0 \\ A < 0 &\Leftrightarrow \lambda_1 \leq \dots \leq \lambda_n < 0 \\ A \text{ indefinite} &\Leftrightarrow \lambda_1 < 0 < \lambda_n \end{aligned}$$

and

$$\lambda_1 \langle \mathbf{x}, \mathbf{x} \rangle \leq \langle A\mathbf{x}, \mathbf{x} \rangle \leq \lambda_n \langle \mathbf{x}, \mathbf{x} \rangle$$

for any $\mathbf{x} \in \mathbb{R}^n$.

Example. In the case where $n = 2$, let $A \in M_{2,2}(\mathbb{R})$ be a symmetric matrix such that

$$A = \begin{pmatrix} p & q \\ q & r \end{pmatrix}.$$

Then $\text{tr } A = p + r = \lambda_1 + \lambda_2$ and $\det A = pr - q^2 = \lambda_1 \lambda_2$. Consequently, for a matrix $A \in M_{2,2}(\mathbb{R})$,

1. $A \geq 0$ if and only if $\det A \geq 0$ and $\text{tr } A \geq 0$.
2. $A > 0$ if and only if $\det A > 0$ and $\text{tr } A \geq 0$.
3. $A \leq 0$ if and only if $\det A \geq 0$ and $\text{tr } A \leq 0$.
4. $A < 0$ if and only if $\det A > 0$ and $\text{tr } A \leq 0$.
5. A is indefinite if and only if $\det A < 0$.

Local extrema - sufficient conditions.

1. If $A < 0$, then $\mathbf{0}$ is a strict local maximum of $q(\mathbf{x})$.
2. If $A > 0$, then $\mathbf{0}$ is a strict local minimum of $q(\mathbf{x})$.
3. If A is indefinite, then $\mathbf{0}$ is a saddle point of $q(\mathbf{x})$.

Remark. In Chapter 5.3 we will extend these three conditions to stationary points of real valued functions of class C^2 where the matrix A corresponds to the Hessian matrix of these stationary points.

Remark. We have already seen that the quadratic form $q(\mathbf{x})$ has a stationary point $\mathbf{a} \neq \mathbf{0}$ if and only if 0 is an eigenvalue of A . Consequently, if $A < 0$ (respectively $A > 0$), $\mathbf{a} = \mathbf{0}$ is the only stationary point of $q(\mathbf{x})$ and therefore, the quadratic form has a global extremum at 0.

Remark. For quadratic forms, the weaker condition $A \leq 0$ (respectively $A \geq 0$) implies that A has a local maximum (respectively a local minimum). However, for general functions these conditions are not sufficient.

5.3 Finite expansion

Theorem 5.2. - finite expansion of order 2. Let $U \subset \mathbb{R}^n$ be open and $f : U \rightarrow \mathbb{R}$ of class $C^2(U)$. Then, for any $\mathbf{a}, \mathbf{a} + \mathbf{h} \in U$:

$$f(\mathbf{a} + \mathbf{h}) = f(\mathbf{a}) + \langle \nabla f(\mathbf{a}), \mathbf{h} \rangle + \frac{1}{2} \langle (\text{Hess } f)(\mathbf{a}) \mathbf{h}, \mathbf{h} \rangle + o(\|\mathbf{h}\|_2^2).$$

Proof. For a fixed \mathbf{h} , consider the function $g : [0, 1] \rightarrow \mathbb{R}$ of class C^2 defined as

$$g(t) = f(\mathbf{a} + t\mathbf{h})$$

From the theorem of finite expansions for single variable functions, there exists $\theta \in [0, 1]$ such that

$$g(1) = g(0) + g'(0) + \frac{g''(0)}{2} + R_2(1)$$

and

$$R_2(1) = \frac{g''(\theta) - g''(0)}{2} (1 - 0)^2 = \frac{g''(\theta) - g''(0)}{2}.$$

By definition of g , $g(0) = f(\mathbf{a})$ and $g(1) = f(\mathbf{a} + \mathbf{h})$. Next, calculate the derivatives of the function $g(t)$:

$$g'(t) = \langle \nabla f(\mathbf{a} + t\mathbf{h}), \mathbf{h} \rangle \quad g'(0) = \langle \nabla f(\mathbf{a}), \mathbf{h} \rangle$$

$$g''(t) = \langle (\text{Hess } f)(\mathbf{a} + t\mathbf{h})\mathbf{h}, \mathbf{h} \rangle$$

and

$$o(\|\mathbf{h}\|_2^2) = \frac{1}{2} \langle (\text{Hess } f)(\mathbf{a} + \theta\mathbf{h}) - (\text{Hess } f)(\mathbf{a})\mathbf{h}, \mathbf{h} \rangle.$$

because Hess f is continuous.

Remark. We can obtain the limited expansion of order k , $k > 2$ using the function $g(t)$. \square

5.4 Local extreme values - sufficient conditions

The theorem of finite expansions enables us to formulate sufficient conditions for a stationary point to be a local extrema.

Theorem 5.3. - sufficient conditions. Let $f : \mathbb{R}^n \rightarrow \mathbb{R}$ be a function of class $C^2(\mathbb{R}^n)$. Let $\mathbf{a} \in \mathbb{R}^n$ be a stationary point of f , i.e. $\nabla f(\mathbf{a}) = \mathbf{0}$ and we note $A = (\text{Hess } f)(\mathbf{a})$.

1. If $A < 0$, then \mathbf{a} is a strict local maximum of $f(\mathbf{x})$.
2. If $A > 0$, then \mathbf{a} is a strict local minimum of $f(\mathbf{x})$.
3. If A is indefinite, then \mathbf{a} is a saddle point of $f(\mathbf{x})$.

This result allows us to find the relative extrema of a function in \mathbb{R}^n or inside a given region. When studying the extrema on a closed set, one must study the behaviour on the edge of the set. We remind the following result for continuous functions (Chapter 1):

Theorem. Let $C \subset \mathbb{R}^n$ be closed and bounded and $f : \mathbb{R}^n \rightarrow \mathbb{R}$ a continuous function on C . Then f reaches its maximum and minimum in C .

Remark. For a continuous function $f : \mathbb{R}^n \rightarrow \mathbb{R}$ on the closed and bounded set C of class $C^k(U)$ with U the interior of C , the extrema are either the stationary points in the interior U or on the edge ∂U .

Example - problem 1. Determine the nature of the stationary points of the function

$$f(x, y) = x^3 - 6x^2 + \frac{1}{8}y^3 - 6y.$$

The stationary points are determined by the condition $\nabla f = 0$, i.e.

$$3x^2 - 12x = 0 \quad \text{and} \quad \frac{3}{8}y^2 - 6 = 0.$$

There are four stationary points of $f(x, y)$:

$$P_1 = (0, 4), P_2 = (0, -4), P_3 = (4, 4), P_4 = (4, -4)$$

We have

$$\text{Hess}(f)(x, y) = \begin{pmatrix} 6x - 12 & 0 \\ 0 & \frac{3}{4}y \end{pmatrix}.$$

and therefore

$$\text{Hess}(f)(P_1) = \begin{pmatrix} -12 & 0 \\ 0 & 3 \end{pmatrix}, \quad f \text{ has a saddle point at } P_1, \quad f(P_1) = -16$$

$$\text{Hess}(f)(P_2) = \begin{pmatrix} -12 & 0 \\ 0 & -3 \end{pmatrix}, \quad f \text{ has a strict local maximum at } P_2, \quad f(P_2) = 16$$

$$\text{Hess}(f)(P_3) = \begin{pmatrix} 12 & 0 \\ 0 & 3 \end{pmatrix}, \quad f \text{ has a strict local minimum at } P_3, \quad f(P_3) = -48$$

$$\text{Hess}(f)(P_4) = \begin{pmatrix} 12 & 0 \\ 0 & -3 \end{pmatrix}, \quad f \text{ has a saddle point at } P_4, \quad f(P_4) = -16$$

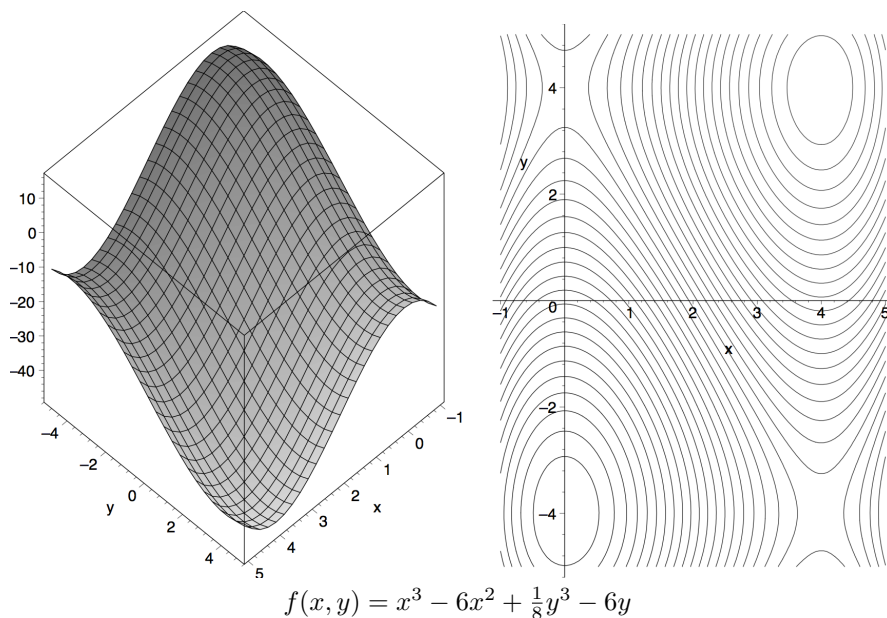

Example - problem 2. Give the maximum and the minimum of $f(x, y)$ (from the previous example) on the rectangle $R = [-2, 5] \times [0, 6]$.

The stationary points P_1 (saddle point) and P_3 (strict local minimum) are in R . We need to study the function f on the edge of R which consists of four segments.

1. $S_1 = \{-2\} \times [0, 6]$. The function $f(x, y)$, constrained to S_1 , is given by

$$f|_{S_1}(x, y) = f(-2, y) = f_1(y) = \frac{1}{8}y^3 - 6y - 32, \quad 0 \leq y \leq 6$$

We have $f_1'(y) = \frac{3}{8}y^2 - 6$. $f_1(y)$ has a stationary point $y_1 = 4$ in $[0, 6]$ (strict local minimum). We also need to compute $f_1(y)$ on the edge of $[0, 6]$, i.e at $y = 0$ and $y = 6$. We find

$$f_1(0) = -32, \quad f_1(4) = -48, \quad f_1(6) = -41.$$

2. $S_2 = [-2, 5] \times \{0\}$. The function $f(x, y)$, constrained to S_2 , is given by

$$f|_{S_2}(x, y) = f(x, 0) = f_2(x) = x^3 - 6x^2, \quad -2 \leq x \leq 5$$

We have $f_2'(x) = 3x^2 - 12x$. $f_2(x)$ has stationary points at $x_1 = 0$ and $x_2 = 4$ in $[-2, 5]$ (strict local maximum and strict local minimum respectively). We also need to compute $f_2(x)$ on the edge of $[0 - 2, 5]$, i.e at $x = -2$ and $x = 5$. We find

$$f_2(-2) = -32, \quad f_2(0) = 0, \quad f_2(4) = -32, \quad f_2(5) = -25.$$

3. $S_3 = \{5\} \times [0, 6]$. The function $f(x, y)$, constrained to S_3 , is given by

$$f|_{S_3}(x, y) = f(5, y) = f_3(y) = \frac{1}{8}y^3 - 6y - 25, \quad 0 \leq y \leq 6$$

Note that $f_3(y) = f_1(y) + 7$. So $f_3(y)$ has the same stationary point and

$$f_3(0) = -25, \quad f_3(4) = -41, \quad f_3(6) = -34.$$

4. $S_4 = [-2, 5] \times \{6\}$. The function $f(x, y)$, constrained to S_4 , is given by

$$f|_{S_4}(x, y) = f(x, 6) = f_4(x) = x^3 - 6x^2 - 9, \quad -2 \leq x \leq 5$$

Note that $f_4(x) = f_2(x) - 9$. $f_4(x)$ has the same stationary points as $f_2(x)$: $x_1 = 0$ and $x_2 = 4$ in $[-2, 5]$ and

$$f_4(-2) = -41, \quad f_4(0) = -9, \quad f_4(4) = -41, \quad f_4(5) = -34.$$

Consequently, $\max f|_R = 0$ is reached at $(0, 0)$ and $\min f|_R = -48$ is reached at P_3 and at $(-2, 4)$.

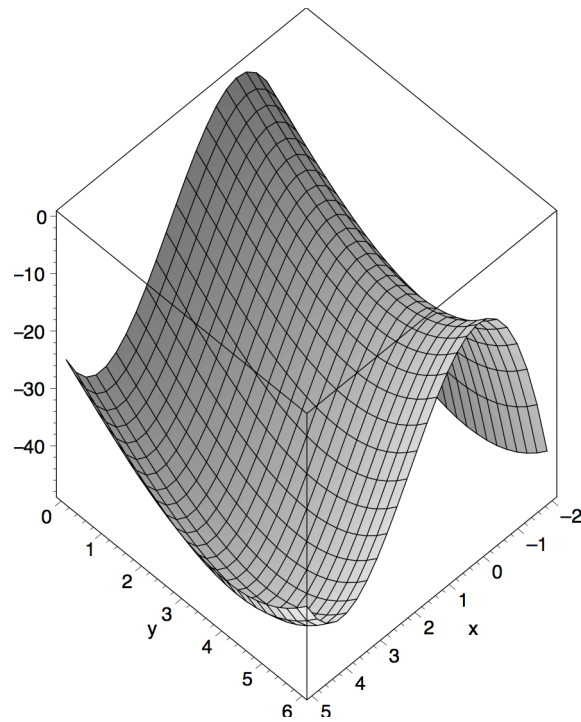

$$f(x, y) = x^3 - 6x^2 + \frac{1}{8}y^3 - 6y \text{ on the rectangle } R.$$

The case with eigenvalue 0 - Examples. If one of the eigenvalues of the Hessian matrix is zero, the theorem of the sufficient conditions is not applicable any more. If $n \geq 3$ and if we have one positive eigenvalue and one negative eigenvalue then the stationary point is a saddle point (by the definition of a saddle point). For example, let

$$f(x, y, z) = x^2 + y^4 - z^2.$$

Then,

$$\nabla f(x, y, z) = \begin{pmatrix} 2x \\ 4y^3 \\ -2z \end{pmatrix}, \quad \nabla f(0, 0, 0) = \mathbf{0}, \quad \text{Hess}(f)(0, 0, 0) = \begin{pmatrix} 2 & 0 & 0 \\ 0 & 0 & 0 \\ 0 & 0 & -2 \end{pmatrix}.$$

The Hessian matrix has the eigenvalues 2, 0, -2. The function f has a saddle point at $\mathbf{0}$ since $f(x, 0, 0) > 0$ for all $x \neq 0$ and $f(0, 0, z) < 0$ for all $z \neq 0$.

If an eigenvalue of the Hessian matrix at a stationary point is zero and the others don't have opposite signs the situation is more complex. For example, the function $g(x, y) = x^2 + y^4$ has a strict local minimum (and even global) at $(0, 0)$. The eigenvalues of the Hessian matrix at this stationary point are 0, 2 and the function $h(x, y) = x^2 - y^4$, which has the same stationary point and the same Hessian matrix at this point, has a saddle point at $(0, 0)$.

Finally, let $f(x, y) = x^2 + y^4 + 2xy^2$. We have

$$\nabla f(x, y) = \begin{pmatrix} 2(x + y^2) \\ 4(y^3 + xy) \end{pmatrix}, \quad \text{Hess}(f)(x, y) = \begin{pmatrix} 2 & 4y \\ 4y & 12y^2 + 4x \end{pmatrix}.$$

The stationary points are given by the equation $x = -y^2$ and the Hessian matrix at these points is

$$\text{Hess}(f)(-y^2, y) = \begin{pmatrix} 2 & 4y \\ 4y & 8y^2 \end{pmatrix}.$$

It has eigenvalues 0 and $2 + 8y^2 > 0$. We can not determine the nature of the stationary points using the Hessian matrix. But noticing that $f(x, y) = (x + y^2)^2 \geq 0$ we find that these points are local minimums (but not strict local minimums as the curve of equation $x = -y^2$ is a curve of the level set of f).

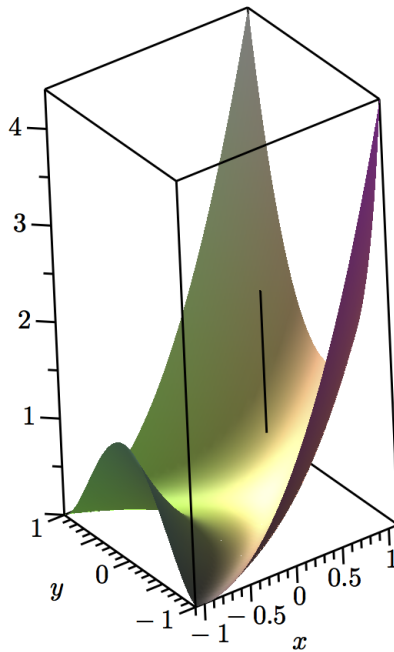

$$f(x, y) = (x + y^2)^2$$

5.5 Extrema of a function under constraints

To analyze the function on the edge of a rectangle (or a triangle) we have substituted the equation of the edge into the function that we are studying. We often look for the extrema of a function $h(\mathbf{x}) = h(x_1, \dots, x_n)$ on a given set by solving the equation $h(\mathbf{x}) = 0$. If we can solve this equation for a real variable, for example $x_n = g(x_1, \dots, x_{n-1})$, we can substitute this expression and study the function of $n - 1$ real variables given by

$$\tilde{h}(x_1, \dots, x_{n-1}) = h(x_1, \dots, x_{n-1}, g(x_1, \dots, x_{n-1}))$$

by using the method presented in the previous section. However, it is often impossible to solve the equation $h(\mathbf{x}) = 0$ for a real variable or such a substitution makes the function \tilde{h} too complex to easily calculate the derivatives. For these situations, there exists another method that follows the idea of substitution and applies the implicit function theorem.

Theorem 5.4. - *The method of Lagrange multipliers I.* Let $U \subset \mathbb{R}^n$ be open. Let $h, f : U \rightarrow \mathbb{R}$ be of class $C^1(U)$ and

$$M = \{\mathbf{x} \in U : f(\mathbf{x}) = 0\}.$$

Let $\mathbf{a} \in M$ such that $\nabla f(\mathbf{a}) \neq \mathbf{0}$ and $h|_M$ has a local extremum at \mathbf{a} . Then there exists a $\lambda \in \mathbb{R}$ such that

$$\nabla h(\mathbf{a}) + \lambda \nabla f(\mathbf{a}) = \mathbf{0}.$$

Proof. We can assume that $D_n f(\mathbf{a}) \neq 0$. By the implicit function theorem there exists a unique function g defined on a neighborhood V of $(a_1, \dots, a_{n-1}) \in \mathbb{R}^{n-1}$ such that for all $(x_1, \dots, x_{n-1}) \in V$:

$$f(x_1, \dots, x_{n-1}, g(x_1, \dots, x_{n-1})) = 0.$$

and

$$D_i f(\mathbf{a}) + D_i g(a_1, \dots, a_{n-1}) D_n f(\mathbf{a}) = 0$$

for any $i = 1, \dots, n - 1$. We consider the function

$$H(x_1, \dots, x_{n-1}) = h(x_1, \dots, x_{n-1}, g(x_1, \dots, x_{n-1})).$$

By assumption, the function H has a local extremum at (a_1, \dots, a_{n-1}) . So $D_i H(a_1, \dots, a_{n-1}) = 0$ for any $i = 1, \dots, n$. The partial derivatives of H at (a_1, \dots, a_{n-1}) verify the relation

$$D_i H(a_1, \dots, a_{n-1}) = D_i h(\mathbf{a}) + D_i g(a_1, \dots, a_{n-1}) D_n h(\mathbf{a}) = 0.$$

If we set

$$\lambda = -\frac{D_n h(\mathbf{a})}{D_n f(\mathbf{a})}$$

then for any $i = 1, \dots, n - 1, n$:

$$D_i h(\mathbf{a}) + \lambda D_i f(\mathbf{a}) = 0.$$

□

Remark. The number λ is called the Lagrange multiplier.

Practical Calculus I. If M is bounded, then the extrema of h exist and we find them as follows: solve the system of equations ($n + 1$ equations)

$$\nabla h(\mathbf{a}) + \lambda \nabla f(\mathbf{a}) = \mathbf{0}, \quad f(\mathbf{a}) = 0 \quad (5.1)$$

for the $n + 1$ variables \mathbf{a}, λ . Then compare the values of h at these points. Note that the theorem does not guarantee the existence of extrema.

Practical Calculus II and discussion of the hypotheses of the theorem.

If $\nabla f(\mathbf{a}) = \mathbf{0}$ for an $\mathbf{a} \in M$, the extrema of $h|_M$ are not necessarily among the solutions of (5.1). In other words, a local extremum of $h|_M$ can be such a point \mathbf{a} . For example, consider $f(x, y) = x^3 - y^7$ and $h(x, y) = x + y^2$. Then, by substitution

$$h|_M(x, y) = y|y|^{\frac{4}{3}} + y^2 > 0 \quad \text{if } -1 < y, y \neq 0,$$

and $h(0, 0) = 0$. Consequently, $h|_M$ has a strict local minimum at $(0, 0) \in M$. If we try applying the method of Lagrange multipliers by solving the system (5.1), we need to solve the equations

$$1 + 3\lambda x^2 = 0, \quad 2y - 7\lambda y^6 = 0, \quad x^3 - y^7 = 0.$$

Observe that $(0, 0)$ is not a solution (this system does not have any solution!). So the method of Lagrange multipliers does not function at the stationary points of f .

We can extend the method of Lagrange multipliers to restrictions on different sets M_k by applying the general version of the implicit function theorem:

Theorem 5.5. - Method of Lagrange multipliers II. Let $U \subset \mathbb{R}^n$ be open. Let $h, f_k : U \rightarrow \mathbb{R}, k = 1, \dots, p$ be of class $C^1(U)$ and

$$M_k = \{\mathbf{x} \in U : f_k(\mathbf{x}) = 0\}.$$

Let $\mathbf{a} \in M_1 \cap \dots \cap M_p$ such that the vectors $\nabla f_k(\mathbf{a})$ are linearly independent and $h|_{M_1 \cap \dots \cap M_p}$ has a local extremum at \mathbf{a} . Then there exists $\lambda_1, \dots, \lambda_p \in \mathbb{R}$ such that

$$\nabla h(\mathbf{a}) + \sum_{k=1}^p \lambda_k \nabla f_k(\mathbf{a}) = \mathbf{0}.$$

Example. Give the maximum and the minimum of the function

$$h(x, y) = x^3 - 6x^2 + \frac{1}{8}y^3 - 6y$$

on $M = \{(x, y) \in \mathbb{R}^2 : x^2 + (y - 2)(y - 6) = 0\}$.

First, note that M is the circle of centre $(0, 4)$ and of radius 2. M is closed and bounded. So, the function h reaches its maximum and its minimum in M . Furthermore, with $f(x, y) = x^2 + (y - 2)(y - 6)$ we have

$$\nabla f(x, y) = \begin{pmatrix} 2x \\ 2(y - 4) \end{pmatrix} \neq \begin{pmatrix} 0 \\ 0 \end{pmatrix} \quad \text{if } \begin{pmatrix} x \\ y \end{pmatrix} \in M.$$

Indeed, $\nabla f(x, y)$ is zero if and only if $x = 0$ and $y = 4$, but $(0, 4) \notin M$. We can apply the theorem, i.e. the minimum and the maximum of $h(x, y)$ are among the solutions of this system of equations

$$\nabla h(x, y) + \lambda \nabla f(x, y) = \mathbf{0}, \quad f(x, y) = 0.$$

Written explicitly, the system of equations is:

$$\begin{aligned} x(3x - 12 + 2\lambda) &= 0 \\ (y - 4)\left(\frac{3}{8}(y + 4) + 2\lambda\right) &= 0 \\ x^2 + (y - 2)(y - 6) &= 0 \end{aligned}$$

Let's analyze this system: using the first equation, we have that either $x = 0$ or $3x - 12 + 2\lambda = 0$. If $x = 0$, then by the third equation $y = 2$ (and so $\lambda = -\frac{9}{8}$, but it is not necessary to compute λ) or $y = 6$ (and so $\lambda = -\frac{16}{8}$). If $y = 4$, then by the third equation $x = 2$ (and so $\lambda = 3$, but again it is not necessary to compute λ) or $x = -2$ (and so $\lambda = 9$). This leaves the case where $3x - 12 + 2\lambda = \frac{3}{8}(y + 4) + 2\lambda = 0$ so $y = 8x - 36$ which has no solutions in M . We have the four solutions:

$$\begin{aligned} (x, y) &= (0, 2) \quad \text{and} \quad h(0, 2) = -11 \\ (x, y) &= (0, 6) \quad \text{and} \quad h(0, 6) = -9 \\ (x, y) &= (-2, 4) \quad \text{and} \quad h(-2, 4) = -48 \\ (x, y) &= (2, 4) \quad \text{and} \quad h(2, 4) = -32 \end{aligned}$$

So $\min h|_M = -48$ and $\max h|_M = -9$.

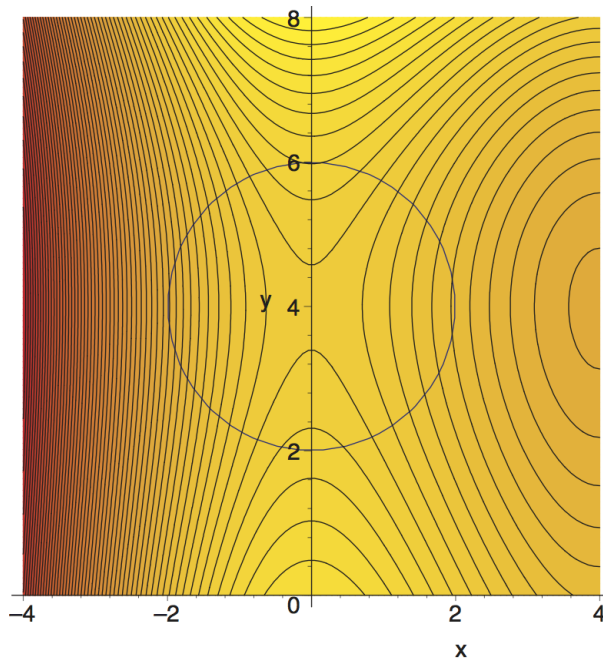

$h(x, y) = x^3 - 6x^2 + \frac{1}{8}y^3 - 6y$ in M (blue circle). At the extrema, the level lines are tangent to the circle.

Example. Find the maximum and the minimum of the function

$$h(x, y, z) = x + y + z$$

under the conditions $f_1(x, y, z) := x^2 + y^2 - 2 = 0$ and $f_2(x, y, z) := x + z - 1 = 0$. The set

$$M := \{(x, y, z) \in \mathbb{R}^3 : f_1(x, y, z) = f_2(x, y, z) = 0\}$$

is closed and bounded. Consequently, the function $h(x, y, z)$ reaches its maximum and its minimum in M . The vectors

$$\nabla f_1(x, y, z) = \begin{pmatrix} 2x \\ 2y \\ 0 \end{pmatrix}, \nabla f_2(x, y, z) = \begin{pmatrix} 1 \\ 0 \\ 1 \end{pmatrix}$$

are linearly independent in M . The minimum and the maximum of $h(x, y, z)$ find themselves among the solutions of the system of equations

$$\nabla h(x, y, z) + \lambda_1 \nabla f_1(x, y, z) + \lambda_2 \nabla f_2(x, y, z) = \mathbf{0}, \quad f_1(x, y, z) = f_2(x, y, z) = 0.$$

Written explicitly, the system of equations is:

$$\begin{aligned} 1 + 2\lambda_1 x + \lambda_2 &= 0 \\ 1 + 2\lambda_1 y &= 0 \\ 1 + \lambda_2 &= 0 \\ x^2 + y^2 - 2 &= 0 \\ x + z - 1 &= 0 \end{aligned}$$

Let's analyze this system: the first and third equation give us $2\lambda_1 x = 0$ i.e. either $x = 0$ or $\lambda_1 = 0$. Recalling the second equation, the last case is impossible. So $x = 0$. The condition $f_1(x, y, z) = 0$ implies that $y = \pm\sqrt{2}$ and $f_2(x, y, z) = 0$ implies that $z = 1$. Furthermore,

$$h(0, \sqrt{2}, 1) = 1 + \sqrt{2} \quad \text{and} \quad h(0, -\sqrt{2}, 1) = 1 - \sqrt{2}.$$

So $\min h|_M = 1 - \sqrt{2}$ and $\max h|_M = 1 + \sqrt{2}$.

Remark. For the last example there is a quicker solution: we can directly inject the relation $z = 1 - x$ into h and look for the extrema of $\tilde{h}(x, y) = y + 1$ under the constraint $x^2 + y^2 = 2$ to obtain the solution without calculations.

Chapter 6

Multiple integrals

6.1 Integrals depending on a parameter

Proposition 1. Let $a < b$ and I be an open interval and $f : [a, b] \times I \rightarrow \mathbb{R}$ a continuous function. Then the function $g : I \rightarrow \mathbb{R}$ defined as

$$g(y) := \int_a^b f(x, y) dx$$

is continuous. If f is continuous and its partial derivative $\frac{\partial f(x, y)}{\partial y}$ is continuous then g is of class $C^1(I)$ and additionally for any $y \in I$:

$$g'(y) := \int_a^b \frac{\partial f(x, y)}{\partial y} dx.$$

Additional: Proof-continuity. The main ingredient of the proof is the fact that the function f is uniformly continuous on the domains $[a, b] \times I_0$ for all $I_0 \subset I$ that is closed and bounded (see Chapter 1). Let $y \in I$, then there exists a $I_0 \subset I$ closed and bounded such that $y \in \overset{\circ}{I}_0$ (the interior of I_0). Thanks to the uniform continuity of f on $[a, b] \times I_0$, for any $\epsilon > 0$, there exists a $\delta > 0$ such that for all $|h| < \delta$ and for all $x \in [a, b]$:

$$(x, y), (x, y + h) \in [a, b] \times I_0 \quad \text{and} \quad |f(x, y + h) - f(x, y)| < \epsilon.$$

Consequently, for any $\epsilon > 0$, there exists a $\delta > 0$ such that for all $|h| < \delta$: $y + h \in I_0$ and

$$|g(y + h) - g(y)| \leq \int_a^b |f(x, y + h) - f(x, y)| dx \leq \epsilon(b - a)$$

proving the continuity of g since ϵ can be chosen arbitrarily small.

Proof - differentiability. We use the uniform continuity of f and of $\partial f / \partial y$ on the domains $[a, b] \times I_0$. Using the mean value theorem:

$$\frac{g(y + h) - g(y)}{h} = \int_a^b \frac{f(x, y + h) - f(x, y)}{h} dx = \int_a^b \frac{\partial f(x, y + h\theta_h)}{\partial y} dx$$

for a $\theta_h \in]0, 1[$. We write

$$\int_a^b \frac{\partial f(x, y + h\theta_h)}{\partial y} dx = \int_a^b \frac{\partial f(x, y)}{\partial y} dx + \int_a^b \frac{\partial f(x, y + h\theta_h)}{\partial y} - \frac{\partial f(x, y)}{\partial y} dx.$$

to establish an estimation of the last integral, like in the first part.

Applications. This Proposition gives us a new technique to calculate integrals, as the next example shows:

Example 1. We want to calculate

$$\int_0^b x^2 \cos x dx.$$

Instead of integration by parts (see Chapter 6 of semester 1) we consider the function

$$g(y) := \int_0^b \cos xy dx$$

on an open interval containing $y = 1$, for example $]1/2, 2[$. Applying Proposition 1, first to $g(y)$:

$$g'(y) := - \int_0^b x \sin xy dx$$

and then to $g'(y)$:

$$g''(y) = - \int_0^b x^2 \cos xy dx,$$

so

$$\int_0^b x^2 \cos x dx = -g''(1)$$

We can determine the function g explicitly:

$$g(y) = \frac{\sin xy}{y} \Big|_0^b = \frac{\sin by}{y}.$$

The derivatives of g are given by

$$g'(y) = - \frac{\sin by}{y^2} + \frac{b \cos by}{y}$$

and

$$g''(y) = \frac{2 \sin by}{y^3} - \frac{2b \cos by}{y^2} - \frac{b^2 \sin by}{y^2}.$$

Therefore,

$$\int_0^b x^2 \cos x dx = -g''(1) = (b^2 - 2) \sin b + 2b \cos b.$$

Generalized integrals. Proposition 1 extends to generalized integrals on $[a, \infty[$ if we can control the behavior of $f(x, y)$ and its partial derivative $\frac{\partial f(x, y)}{\partial y}$ when x goes to infinity:

Proposition 2. Let I be an open interval and $f : [a, \infty[\times I \rightarrow \mathbb{R}$ a continuous function. Let $\phi : [a, \infty[\rightarrow \mathbb{R}_+$ be a function for which the generalized integral

$$\int_a^\infty \phi(x) dx$$

converges as $|f(x, y)| \leq \phi(x)$ for all $(x, y) \in [a, \infty[\times I$. Then the function $g : I \rightarrow \mathbb{R}$ defined as

$$g(y) := \int_a^\infty f(x, y) dx$$

is continuous. If f is continuous and its partial derivative $\frac{\partial f(x, y)}{\partial y}$ is continuous and satisfies $|\frac{\partial f(x, y)}{\partial y}| \leq \psi(x)$ for $(x, y) \in [a, \infty[\times I$ and for a function $\psi : I \rightarrow \mathbb{R}_+$ whose generalized integral exists on $[a, \infty[$, then g is of class $C^1(I)$ and moreover, for any $y \in I$:

$$g'(y) := \int_a^\infty \frac{\partial f(x, y)}{\partial y} dx.$$

Example 2. We want to calculate

$$\int_0^\infty x^3 e^{-x^2} dx$$

We set $I =]1/2, 2[$ and $f(x, y) = x e^{-yx^2}$. The function f satisfies the hypotheses of the proposition with $\phi(x) = x e^{-x^2/2}$ and $\psi(x) = x^3 e^{-x^2/2}$. So

$$g(y) = \int_0^\infty x e^{-yx^2} dx.$$

is of class C^1 and

$$g'(y) = - \int_0^\infty x^3 e^{-yx^2} dx.$$

Note that

$$g(y) = - \int_0^\infty \frac{d}{dx} \left(\frac{e^{-yx^2}}{2y} \right) dx = \frac{1}{2y}.$$

So $g'(y) = \frac{-1}{2y^2}$ and

$$\int_0^\infty x^3 e^{-x^2} dx = -g'(1) = \frac{1}{2}.$$

Integrands and integration bounds with a parameter. If the integration bounds depend on the parameter y of class C^1 we can easily generalize the result of Chapter 6.4.2 of Analysis I to integrals depending on the parameter y .

Proposition 3. Let I, J be two open intervals and $f : J \times I \rightarrow \mathbb{R}$ a function of class C^1 and $a, b : I \rightarrow J$ two functions of class C^1 . Then the function $g : I \rightarrow \mathbb{R}$ defined as

$$g(y) := \int_{a(y)}^{b(y)} f(x, y) dx$$

is of class $C^1(I)$ and, moreover, for any $y \in I$:

$$g'(y) := f(b(y), y)b'(y) - f(a(y), y)a'(y) + \int_{a(y)}^{b(y)} \frac{\partial f(x, y)}{\partial y} dx.$$

Proof. Simply note that for all $y, y + h \in I$:

$$\begin{aligned} \frac{g(y+h) - g(y)}{h} &= \frac{1}{h} \int_{b(y)}^{b(y+h)} f(x, y+h) dx - \frac{1}{h} \int_{a(y)}^{a(y+h)} f(x, y+h) dx \\ &\quad + \frac{1}{h} \int_{a(y)}^{b(y)} f(x, y+h) - f(x, y) dx. \end{aligned}$$

This statement follows from the uniform continuity of f and the mean value theorem.

Example 3. Calculate

$$\lim_{y \rightarrow 0} \int_0^y \frac{(y-x) \cos x^2}{\sin y^2} dx.$$

We define

$$g(y) = \int_0^y (y-x) \cos x^2 dx.$$

Then

$$g'(y) = \int_0^y \cos x^2 dx, \quad g''(y) = \cos y^2.$$

Let's note that $(\sin y^2)'' = (2y \cos y^2)' = 2 \cos y^2 + 4y^2 \sin y^2$. So

$$\lim_{y \rightarrow 0} \frac{g''(y)}{(\sin y^2)''} = \frac{1}{2}$$

and by l'Hôpital's rule:

$$\lim_{y \rightarrow 0} \int_0^y \frac{(y-x) \cos x^2}{\sin y^2} dx \equiv \lim_{y \rightarrow 0} \frac{g(y)}{\sin y^2} = \lim_{y \rightarrow 0} \frac{g''(y)}{(\sin y^2)''} = \frac{1}{2}.$$

Extension to n paramters. In the Propositions 1 -3 we can replace the parameter y by n parameters \mathbf{y} by switching to the partial derivatives of

$$g(\mathbf{y}) := \int_a^b f(x, \mathbf{y}) dx \quad \text{or} \quad g(\mathbf{y}) := \int_{a(\mathbf{y})}^{b(\mathbf{y})} f(x, \mathbf{y}) dx.$$

Then, under the same hypotheses,

$$\frac{\partial g(\mathbf{y})}{\partial y_k} = \int_a^b \frac{\partial f(x, \mathbf{y})}{\partial y_k} dx$$

respectively

$$\frac{\partial g(\mathbf{y})}{\partial y_k} = \frac{\partial b(\mathbf{y})}{\partial y_k} f(b(\mathbf{y}), \mathbf{y}) - \frac{\partial a(\mathbf{y})}{\partial y_k} f(a(\mathbf{y}), \mathbf{y}) + \int_{a(\mathbf{y})}^{b(\mathbf{y})} \frac{\partial f(x, \mathbf{y})}{\partial y_k} dx.$$

6.2 Double integrals

Let $D \subset \mathbb{R}^2$ and $f : D \rightarrow \mathbb{R}$ be a continuous function. We define the double integral

$$\iint_D f(x, y) dx dy.$$

for a few types of domains D without presenting a theory of integration.

6.2.1 Double integral on a closed rectangle

Let $a < b$, $c < d$ and $f : [a, b] \times [c, d] \rightarrow \mathbb{R}$ a continuous function. Then, using Proposition 1, the functions $g : [c, d] \rightarrow \mathbb{R}$ and $h : [a, b] \rightarrow \mathbb{R}$ defined by

$$g(y) := \int_a^b f(x, y) dx \quad \text{and} \quad h(x) := \int_c^d f(x, y) dy$$

are continuous. So the integrals

$$\int_c^d g(y) dy, \quad \int_a^b h(x) dx$$

exist. Furthermore, we have

Theorem 1 - Fubini Theorem for continuous functions.

$$\int_c^d g(y) dy = \int_a^b h(x) dx.$$

We can define the double integral on a closed rectangle $D = [a, b] \times [c, d]$ by

$$\begin{aligned} \iint_D f(x, y) dx dy &= \int_c^d g(y) dy = \int_c^d \left(\int_a^b f(x, y) dx \right) dy \\ &= \int_a^b h(x) dx = \int_a^b \left(\int_c^d f(x, y) dy \right) dx \end{aligned}$$

Proof. We define the function $\psi : [c, d] \rightarrow \mathbb{R}$ by

$$\psi(x, t) = \int_c^t f(x, y) dy.$$

and the function $\phi : [c, d] \rightarrow \mathbb{R}$ by

$$\phi(t) = \int_a^b \psi(x, t) dx = \int_a^b \left(\int_c^t f(x, y) dy \right) dx.$$

We have $\psi(x, c) \equiv 0$ and so $\phi(c) = 0$. Using Proposition 1, the function $\psi(x, t)$ is continuous. By the fundamental theorem of calculus, its partial derivative relatively to t is continuous. Then, by Proposition 1 $\phi(t)$ is differentiable and

$$\phi'(t) = \int_a^b \frac{\partial}{\partial t} \psi(x, t) dx = \int_a^b \frac{\partial}{\partial t} \left(\int_c^t f(x, y) dy \right) dx = \int_a^b f(x, t) dx = g(t)$$

Consequently,

$$\int_c^d g(t) dt = \int_c^d \phi'(t) dt = \phi(d) = \int_a^b \left(\int_c^d f(x, y) dy \right) dx = \int_a^b h(x) dx.$$

The double integral verifies the properties of linearity and monotonicity.

Theorem 2. Let $D = [a, b] \times [c, d]$ and $f, g : D \rightarrow \mathbb{R}$ be two continuous functions. Then for any $\alpha, \beta \in \mathbb{R}$:

$$\iint_D (\alpha f(x, y) + \beta g(x, y)) dx dy = \alpha \iint_D f(x, y) dx dy + \beta \iint_D g(x, y) dx dy \quad (6.1)$$

If $f(x, y) \leq g(x, y)$ for all $(x, y) \in D$, then

$$\iint_D f(x, y) dx dy \leq \iint_D g(x, y) dx dy. \quad (6.2)$$

$$\left| \iint_D f(x, y) dx dy \right| \leq \iint_D |f(x, y)| dx dy. \quad (6.3)$$

Mean value theorem. Let $D = [a, b] \times [c, d]$ and $f, g : D \rightarrow \mathbb{R}$ be two continuous functions and $g \geq 0$. Then, there exists (at least) one $(x_0, y_0) \in D$ such that

$$\iint_D f(x, y)g(x, y) dx dy = f(x_0, y_0) \iint_D g(x, y) dx dy$$

In particular, if $g \equiv 1$:

$$\iint_D f(x, y) dx dy = f(x_0, y_0) \text{Area}(D) = f(x_0, y_0)|D|.$$

Consequently,

$$\iint_D dx dy = \text{Area}(D) = |D| = \text{Vol}(D \times [0, 1]).$$

Examples.

1. Let $D = [a, b] \times [c, d]$ and $f : [a, b] \rightarrow \mathbb{R}$, $g : [c, d] \rightarrow \mathbb{R}$ be two continuous functions. Then,

$$\iint_D f(x)g(y) dx dy = \int_a^b f(x) dx \cdot \int_c^d g(y) dy.$$

For example,

$$\iint_{[0,1] \times [0,2]} e^{x+2y} dx dy = \int_0^1 e^x dx \cdot \int_0^2 e^{2y} dy = (e - 1) \cdot \left(\frac{e^4 - 1}{2}\right).$$

- 2.

$$\begin{aligned} \iint_{[0,\pi/2] \times [0,\pi/2]} \sin(x+y) dx dy &= \int_0^{\pi/2} (-\cos(x+\pi/2) + \cos x) dx \\ &= \int_0^{\pi/2} \cos x + \sin x dx = 2 \end{aligned}$$

Interpretation of the double integral. Let $D = [a, b] \times [c, d]$ and $f : D \rightarrow \mathbb{R}_+$ be a continuous function. We define

$$E = \{(x, y, z) \in \mathbb{R}^3 : (x, y) \in D : \text{and } 0 \leq z \leq f(x, y)\}$$

Then the volume of E , written $\text{Vol}(E)$, is given by

$$\text{Vol}(E) = \iint_D f(x, y) \, dx dy.$$

Example - volume of a pyramid. Let $a > 0$, $D = [-a/2, a/2] \times [-a/2, a/2]$ and $f : D \rightarrow \mathbb{R}_+$ be defined as

$$f(x, y) = h(1 - \max(2|x|/a, 2|y|/a))$$

The set $E \in \mathbb{R}^3$ defined above describes a pyramid of height h and of base D . To calculate the volume of E we note that

$$\text{Vol}(E) = 4h \iint_{[0, a/2] \times [0, a/2]} f(x, y) \, dx dy.$$

So

$$\begin{aligned} \text{Vol}(E) &= 4h \int_0^{a/2} \left(\int_0^y (1 - 2y/a) \, dx + \int_y^{a/2} (1 - 2x/a) \, dx \right) dy \\ &= 4h \int_0^{a/2} \left(y(1 - 2y/a) + (a/2 - y) - \left(\frac{(a/2)^2}{a} - \frac{y^2}{a} \right) \right) dy \\ &= 4h \int_0^{a/2} \left(\frac{a}{4} - \frac{y^2}{a} \right) dy \\ &= 4h \left(\frac{a^2}{8} - \frac{a^2}{24} \right) \\ &= \frac{ha^2}{3} \end{aligned}$$

Almost disjoint closed rectangles. A subset D of \mathbb{R}^2 is called a closed rectangle if it is given as the Cartesian product of two closed and bounded intervals: $D = [a, b] \times [c, d]$. We call $(D_k)_{k \in \mathbb{N}}$ a family of almost disjoint rectangles if for any couple of integers $n \neq m$:

$$\overset{\circ}{D}_n \cap \overset{\circ}{D}_m = \emptyset.$$

For any continuous function $f : \mathbb{R}^2 \rightarrow \mathbb{R}$ we have:

$$\iint_{\bigcup_k D_k} f(x, y) \, dx dy = \sum_k \iint_{D_k} f(x, y) \, dx dy.$$

If D is the reunion of the rectangles of a family of almost disjoint rectangles and $f, g : D \rightarrow \mathbb{R}$ are two continuous and bounded functions such that $f < g$ on D . Then, the volume

$$E = \{(x, y, z) \in \mathbb{R}^3 : (x, y) \in D : \text{and } f(x, y) \leq z \leq g(x, y)\}$$

is given by

$$\text{Vol}(E) = \iint_D g(x, y) - f(x, y) \, dx dy.$$

This extension allows us to treat generalized integrals such as, for example, f continuous on an open rectangle:

$$\iint_{[0,1] \times [0,1]} \frac{1}{\sqrt{xy}} \, dx dy = \int_0^1 \frac{1}{\sqrt{x}} \, dx \int_0^1 \frac{1}{\sqrt{y}} \, dy = 4.$$

We notice that the double integral on these domains verifies the properties of linearity and monotonicity (6.1) - (6.3) and the mean value theorem.

Calculating double integrals. The technique introduced in the previous example can be generalized as follows: let $\phi, \psi : [a, b] \rightarrow \mathbb{R}$ be two continuous functions such that $\phi(x) < \psi(x)$ for all $x \in]a, b[$. We consider the open and bounded set D defined by

$$D = \{(x, y) \in \mathbb{R}^2 : x \in]a, b[\text{ and } \phi(x) < y < \psi(x)\}$$

Then, for any continuous function

$$f : \bar{D} = \{(x, y) \in \mathbb{R}^2 : x \in [a, b] \text{ and } \phi(x) \leq y \leq \psi(x)\} \rightarrow \mathbb{R},$$

we have

$$\iint_D f(x, y) \, dx dy = \int_a^b \left(\int_{\phi(x)}^{\psi(x)} f(x, y) \, dy \right) dx.$$

For any $t \in]a, b[$ the function $A :]a, b[\rightarrow \mathbb{R}$ defined by

$$A(t) = \int_{\phi(t)}^{\psi(t)} f(t, y) \, dy$$

gives the surface obtained by dividing the set

$$E = \{(x, y, z) \in \mathbb{R}^3 : (x, y) \in D \text{ and } 0 \leq z \leq f(x, y)\}$$

by the plane of equation $x = t$. The volume of E is

$$\text{Vol}(E) = \int_a^b A(t) \, dt.$$

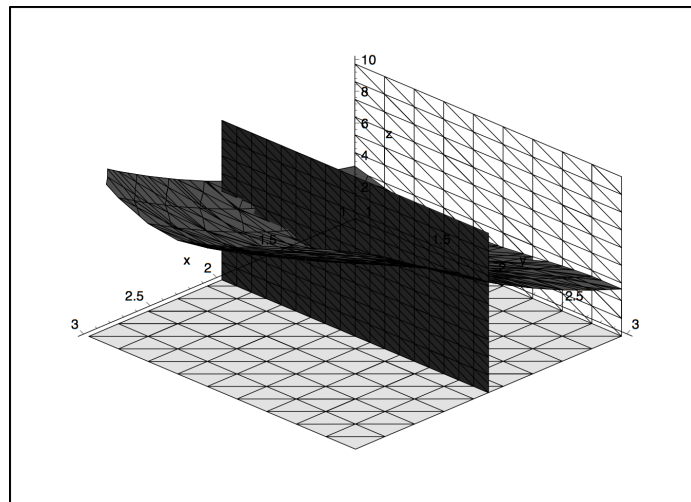

More generally, if $g : \bar{D} \rightarrow \mathbb{R}$ is a continuous function such that $f < g$ in D , then for any $t \in]a, b[$ the function $A :]a, b[\rightarrow \mathbb{R}$ defined as

$$A(t) = \int_{\phi(t)}^{\psi(t)} (g(t, y) - f(t, y)) dy$$

describes the surface obtained by cutting the set

$$E = \{(x, y, z) \in \mathbb{R}^3 : (x, y) \in D : \text{et } f(x, y) \leq z \leq g(x, y)\}$$

with the plane of equation $x = t$. The volume of E is

$$\text{Vol}(E) = \int_a^b A(t) dt.$$

In the example of the pyramid we can divide by the plane of equation $y = t$. We have $A(t) = (1 - \frac{t}{h})^2 a^2$, $t \in [0, h]$, from which we get

$$\text{Vol}(E) = a^2 \int_0^h (1 - \frac{t}{h})^2 dt = a^2 h \int_0^1 (1 - s)^2 ds = \frac{A(0)h}{3}.$$

Example - triangular domain. Let $D \subset \mathbb{R}^2$ be the triangle given by

$$\begin{aligned} D &= \{(x, y) \in \mathbb{R}^2 : 0 \leq x \leq 1, 0 \leq y \leq x\} \\ &= \{(x, y) \in \mathbb{R}^2 : 0 \leq y \leq 1, y \leq x \leq 1\} \end{aligned}$$

Then, for any continuous function on D :

$$\begin{aligned} \iint_D f(x, y) dx dy &= \int_0^1 \left(\int_0^x f(x, y) dy \right) dx \\ &= \int_0^1 \left(\int_y^1 f(x, y) dx \right) dy \end{aligned}$$

If $f(x, y) = \sinh x^2$ the second expression for the double integral on D is not applicable as you need to know the primitive function of $\sinh x^2$. However,

$$\iint_D f(x, y) dx dy = \int_0^1 \left(\int_0^x \sinh x^2 dy \right) dx = \int_0^1 x \sinh x^2 dx = \frac{\cosh x^2}{2} \Big|_0^1$$

Let T be the triangle given by the vertices $A = (0, 0)$, $B = (4, 0)$, $C = (0, 3)$. Then,

$$\begin{aligned} T &= \{(x, y) \in \mathbb{R}^2 : 0 \leq x \leq 4, 0 \leq y \leq 3 - \frac{3x}{4}\} \\ &= \{(x, y) \in \mathbb{R}^2 : 0 \leq y \leq 3, 0 \leq x \leq 4 - \frac{4y}{3}\}. \end{aligned}$$

So,

$$\begin{aligned}
\iint_T \frac{x}{3x+4y} dx dy &= \int_0^4 dx \int_0^{3-\frac{3x}{4}} dy \frac{x}{3x+4y} \\
&= \int_0^4 dx \frac{x}{4} \ln(3x+4y) \Big|_{y=0}^{y=3-\frac{3x}{4}} \\
&= \int_0^4 dx \frac{x}{4} (\ln 12 - \ln 3x) = \frac{1}{4} \int_0^4 dx (2 \ln 2)x - x \ln x \\
&= \frac{(4 \ln 2)x^2 - 2x^2 \ln x + x^2}{16} \Big|_{x=0}^{x=4} = 1.
\end{aligned}$$

Example - the parity of the domain and the function. Let $D = B_1(\mathbf{0}) \subset \mathbb{R}^2$ be the unit ball. Calculate

$$\iint_D x^2 \sin y dx dy.$$

We have

$$\iint_D x^2 \sin y dx dy = \int_{-1}^1 x^2 \left(\int_{-\sqrt{1-x^2}}^{\sqrt{1-x^2}} \sin y dy \right) dx = 2 \int_{-1}^1 0 dx = 0.$$

More generally, let D be a domain such that $(x, y) \in D$ implies that $(x, -y) \in D$. If f is a continuous function on D and odd at y , then

$$\begin{aligned}
\iint_D f(x, y) dx dy &= \iint_{D \cap \{y > 0\}} f(x, y) dx dy + \iint_{D \cap \{y < 0\}} f(x, y) dx dy \\
&= \iint_{D \cap \{y > 0\}} f(x, y) dx dy + \iint_{D \cap \{y > 0\}} f(x, -y) dx dy \\
&= \iint_{D \cap \{y > 0\}} f(x, y) dx dy + \iint_{D \cap \{y > 0\}} -f(x, y) dx dy = 0
\end{aligned}$$

6.2.2 Double integrals on \mathbb{R}^2

Here we define the double integral

$$\iint_{\mathbb{R}^2} f(x, y) dx dy$$

of a continuous function $f : \mathbb{R}^2 \rightarrow \mathbb{R}$ as the limit of the integrals on bounded rectangles D_k such that $D_k \rightarrow \mathbb{R}^2$ when $k \rightarrow \infty$ (in analogy to Analysis I). An important property of the double integral on \mathbb{R}^2 is its invariance when translated: for any $(x_0, y_0) \in \mathbb{R}^2$,

$$\iint_{\mathbb{R}^2} f(x - x_0, y - y_0) dx dy = \iint_{\mathbb{R}^2} f(x, y) dx dy.$$

This invariance to translation is valid if the translation in one real variable, for example, $x_0 = x_0(y)$, is a continuous function of the other variable.

Example. To calculate

$$I := \iint_{\mathbb{R}^2} \frac{e^{x-\frac{y^2}{2}}}{(1+e^{x+\frac{y^2}{2}})^2} dx dy$$

we first note that

$$\begin{aligned} \int_{\mathbb{R}} \frac{e^{x-\frac{y^2}{2}}}{(1+e^{x+\frac{y^2}{2}})^2} dx &= e^{-y^2} \int_{\mathbb{R}} \frac{e^{x+\frac{y^2}{2}}}{(1+e^{x+\frac{y^2}{2}})^2} dx \\ &= e^{-y^2} \int_{\mathbb{R}} \frac{e^x}{(1+e^x)^2} dx \\ &= e^{-y^2} \int_{\mathbb{R}} \frac{d}{dx} \left(\frac{-1}{1+e^x} \right) dx = e^{-y^2}. \end{aligned}$$

Therefore, by the change of variable $y^2 = t$:

$$I = \int_{\mathbb{R}} e^{-y^2} dy = 2 \int_0^{\infty} e^{-y^2} dy = \int_0^{\infty} t^{-\frac{1}{2}} e^{-t} dt = \Gamma\left(\frac{1}{2}\right) = \sqrt{\pi}.$$

6.2.3 Change of variables in \mathbb{R}^2

An interpretation of the determinant. Let $\mathbf{v}, \mathbf{w} \in \mathbb{R}^2$ be linearly independent. The set

$$D = \{s\mathbf{v} + t\mathbf{w}, 0 \leq s \leq 1, 0 \leq t \leq 1\}$$

describes a parallelogram in \mathbb{R}^2 . Its area is given by

$$|D| := \text{Area}(D) = |\det(\mathbf{v}, \mathbf{w})|$$

The change of area by continuous functions. Let $A \in M_{2,2}(\mathbb{R})$ be invertible and $\lambda_A : \mathbb{R}^2 \rightarrow \mathbb{R}^2$ be the linear mapping defined as $\lambda_A(\mathbf{x}) = A\mathbf{x}$. Let $C = [0, 1] \times [0, 1]$. Then the set $\lambda_A(C)$ is a parallelogram in \mathbb{R}^2 . Its area is given by

$$|\lambda_A(C)| := \text{Area}(\lambda_A(C)) = |\det(A)|.$$

Formula for the change of variables for linear mappings. Let $A \in M_{2,2}(\mathbb{R})$ be invertible, then

$$\iint_C f(\lambda_A(s, t)) |\det(A)| ds dt = \iint_{\lambda_A(C)} f(x, y) dx dy.$$

Example. For a diagonal matrix $A = \text{diag}(\lambda, \mu)$ we have

$$\int_0^1 \int_0^1 f(\lambda t, \mu s) |\lambda\mu| ds dt = \int_0^\lambda \int_0^\mu f(x, y) dx dy.$$

Example. Let $\mathbf{v} = \begin{pmatrix} 1 \\ 2 \end{pmatrix}$, $\mathbf{w} = \begin{pmatrix} 3 \\ 4 \end{pmatrix}$. Calculate the following integral on the parallelogram $D = \{s\mathbf{v} + t\mathbf{w}, 0 \leq s \leq 1, 0 \leq t \leq 1\}$:

$$\iint_D x + y \, dx dy = \int_0^1 \int_0^1 ((s + 3t) + (2s + 4t)) \cdot 2 \, ds dt = 10.$$

The change of variables. Let $\psi : U \rightarrow V$ be a bijective mapping of class $C^1(U)$. We set $\psi(s, t) = (x, y)$. Then, for any function $f : V \rightarrow \mathbb{R}$ that can be integrated

$$\iint_U f(\psi(s, t)) |\det J_\psi(s, t)| \, ds dt = \iint_V f(x, y) \, dx dy.$$

Example - polar coordinates. Let $\psi(r, \phi) = (r \cos \phi, r \sin \phi) = (x, y)$. So $\det J_\psi(r, \phi) = r$. Let $D = \{(x, y) : x^2 + y^2 \leq R^2\}$ be a disc of radius R . Then,

$$\iint_{[0, R] \times [0, 2\pi]} f(r \cos \phi, r \sin \phi) r \, dr d\phi = \iint_D f(x, y) \, dx dy.$$

In particular,

$$\iint_{[0, \infty] \times [0, 2\pi]} f(r \cos \phi, r \sin \phi) r \, dr d\phi = \iint_{\mathbb{R}^2} f(x, y) \, dx dy.$$

This change of variable allows us to calculate the Gauss integral

$$I := \int_{\mathbb{R}} e^{-\frac{x^2}{2}} \, dx$$

since

$$\begin{aligned} I^2 &= \left(\int_{\mathbb{R}} e^{-\frac{x^2}{2}} \, dx \right)^2 \\ &= \int_{\mathbb{R}} e^{-\frac{x^2}{2}} \, dx \int_{\mathbb{R}} e^{-\frac{y^2}{2}} \, dy \\ &= \iint_{\mathbb{R}^2} e^{-\frac{x^2+y^2}{2}} \, dx dy \\ &= \iint_{[0, \infty] \times [0, 2\pi]} e^{-\frac{r^2}{2}} r \, dr d\phi \\ &= 2\pi \int_0^\infty e^{-\frac{r^2}{2}} r \, dr \\ &= -2\pi e^{-\frac{r^2}{2}} \Big|_0^\infty \\ &= 2\pi. \end{aligned}$$

If the function $f(x, y)$ is a spherical function i.e. $f(x, y) = g(r)$, then

$$\iiint_{B_R} f(x, y) \, dx dy = 2\pi \int_{[0, R]} g(r) r \, dr.$$

The 2π factor corresponds to the arc-length of a unit circle $\mathbf{S}_1 \subset \mathbf{R}^2$.

6.2.4 Calculating multiple integrals

Multiple integrals. Let $f : \mathbb{R}^3 \rightarrow \mathbb{R}$ be continuous. By generalizing the construction of the double integral described above we can define

$$\iiint_D f(x, y, z) \, dx dy dz$$

where $D = [a_1, b_1] \times [a_2, b_2] \times [a_3, b_3]$ or D is an open bounded set in \mathbb{R}^3 or even $D = \mathbb{R}^3$. In particular,

$$\text{Vol}(D) = |D| = \iiint_D dx dy dz.$$

More generally, for a continuous function $f : \mathbb{R}^n \rightarrow \mathbb{R}$ we can define

$$\int \dots \int_D f(x_1, \dots, x_n) \, dx_1 \dots dx_n$$

for suitable domains D .

The change of variables. Let $\psi : U \rightarrow V$ be a bijective mapping of class $C^1(U)$. We set $\psi(t_1, \dots, t_n) = (x_1, \dots, x_n)$. Then for any function $f : V \rightarrow \mathbb{R}$ that can be integrated

$$\int \dots \int_U f(\psi(t_1, \dots, t_n)) |\det J_\psi(t_1, \dots, t_n)| dt_1, \dots, dt_n = \int \dots \int_V f(x_1, \dots, x_n) dx_1 \dots dx_n.$$

Example - spherical coordinates. Let

$$\psi(r, \theta, \phi) = (r \sin \theta \cos \phi, r \sin \theta \sin \phi, r \cos \theta) = (x, y, z)$$

with $r > 0, \theta \in [0, \pi], \phi \in [0, 2\pi]$. Then $\det J_\psi(r, \theta, \phi) = r^2 \sin \theta > 0$. Let $D = B_R = \{(x, y, z) : x^2 + y^2 + z^2 \leq R^2\}$ be the ball of radius R . Then,

$$\begin{aligned} & \iiint_{[0, R] \times [0, \pi] \times [0, 2\pi]} f(r \sin \theta \cos \phi, r \sin \theta \sin \phi, r \cos \theta) r^2 \sin \theta \, dr d\theta d\phi = \\ & \iiint_{B_R} f(x, y, z) \, dx dy dz. \end{aligned}$$

In particular,

$$\begin{aligned} & \iiint_{[0, \infty] \times [0, \pi] \times [0, 2\pi]} f(r \sin \theta \cos \phi, r \sin \theta \sin \phi, r \cos \theta) r^2 \sin \theta \, dr d\theta d\phi = \\ & \iiint_{\mathbb{R}^3} f(x, y, z) \, dx dy dz. \end{aligned}$$

The integral in spherical coordinates consists of an integral on the unit sphere (the angles θ, ϕ) of radius r . If the function $f(x, y, z)$ is a spherical function, i.e. $f(x, y, z) = g(r)$, then

$$\iiint_{B_R} f(x, y, z) \, dx dy dz = 4\pi \int_{[0, R]} g(r) r^2 \, dr.$$

The 4π factor corresponds to the area of the unit sphere $\mathbf{S}_2 \subset \mathbf{R}^3$ and $4\pi r^2$ represents the area of a sphere of radius r . In particular,

$$\text{Vol}(B_R) = \iiint_{B_R} dx dy dz = 4\pi \int_0^R r^2 \, dr = \frac{4\pi R^3}{3}.$$

Example - mass distribution. Let $D \subset \mathbf{R}^3$ be bounded and $f : D \rightarrow \mathbb{R}_+$ a continuous function. We can interpret f as a density of mass. Then,

$$M = \iiint_D f(x, y, z) \, dx dy dz$$

represents the mass of the body D and the integrals

$$R_x = \frac{1}{M} \iiint_D x f(x, y, z) \, dx dy dz,$$

$$R_y = \frac{1}{M} \iiint_D y f(x, y, z) \, dx dy dz,$$

$$R_z = \frac{1}{M} \iiint_D z f(x, y, z) \, dx dy dz$$

are the coordinates of the center of gravity of D . If $D = B_R$ and $f = e^{-r}$ then

$$M = \iiint_{B_R} e^{-r} \, dx dy dz = 4\pi \int_{[0, R]} e^{-r} r^2 \, dr = 8\pi(1 - (1 + R + R^2/2)e^{-R})$$

and $R_x = R_y = R_z = 0$.

Example - volume of a solid of revolution. Let $f : [a, b] \rightarrow \mathbf{R}$ be a continuous function. The subset E of \mathbf{R}^3 obtained by the rotation of the surface delimited by the graph of f around the axis Ox is given by

$$E = \{(x, y, z) \in \mathbf{R}^3 : x \in [a, b], y^2 + z^2 < f^2(x)\}$$

Then, by taking polar coordinates for y, z , we obtain

$$\text{Vol}(E) = \iiint_E \, dx dy dz = 2\pi \int_a^b \left(\int_0^{|f(x)|} r \, dr \right) dx = \pi \int_a^b f^2(x) \, dx.$$

Example - Radial function in \mathbf{R}^n and volume of the unit ball Let $f : \mathbf{R}^n \rightarrow \mathbf{R}$ be a radial function (spherical), that is $f(\mathbf{x}) = g(\|\mathbf{x}\|_2)$ for all $\mathbf{x} \in \mathbf{R}^n$. Then :

$$\int_{\mathbf{R}^n} f(\mathbf{x}) \, d\mathbf{x} = |S_{n-1}| \int_0^\infty g(r) r^{n-1} \, dr$$

where $|S_{n-1}| = \text{Vol}_{n-1}(\{\mathbf{x} \in \mathbf{R}^n : \|\mathbf{x}\|_2 = 1\})$ designates the area of the unit sphere of \mathbf{R}^n . By taking $g(r) = 1$ if $0 \leq r \leq 1$ and $g(r) = 0$ otherwise, we find the volume of the unit ball $B_1(\mathbf{0}) = \{\mathbf{x} \in \mathbf{R}^n : \|\mathbf{x}\|_2 \leq 1\}$:

$$B_n := \text{Vol}_n(B_1(\mathbf{0})) = |S_{n-1}| \int_0^1 r^{n-1} \, dr = \frac{|S_{n-1}|}{n}.$$

Consequently, if $R > 0$

$$\text{Vol}_n(B_R(\mathbf{0})) = B_n R^n.$$

To calculate B_n we use the Gaussian functions $f(\mathbf{x}) = e^{-\|\mathbf{x}\|_2^2} = \prod_{k=1}^n e^{-x_k^2}$. On one hand,

$$\int_{\mathbf{R}^n} f(\mathbf{x}) \, d\mathbf{x} = |S_{n-1}| \int_0^\infty e^{-r^2} r^{n-1} \, dr = \frac{|S_{n-1}|}{2} \int_0^\infty e^{-s} s^{\frac{n-1}{2}} \, ds = \frac{|S_{n-1}|}{2} \Gamma\left(\frac{n}{2}\right)$$

by the change of variable $s = r^2$. On the other hand,

$$\int_{\mathbf{R}^n} f(\mathbf{x}) d\mathbf{x} = \prod_{k=1}^n \int_{\mathbf{R}} e^{-x_k^2} dx_k = \pi^{\frac{n}{2}}$$

since

$$\int_{\mathbf{R}} e^{-x_k^2} dx_k = 2 \int_0^{\infty} e^{-x_k^2} dx_k = \int_0^{\infty} e^{-s} s^{-\frac{1}{2}} ds = \Gamma\left(\frac{1}{2}\right) = \sqrt{\pi}.$$

It follows that

$$B_n = \frac{\pi^{\frac{n}{2}}}{\Gamma\left(\frac{n}{2} + 1\right)}. \quad (6.4)$$

Chapter 7

Differential equations

7.1 Classification of differential equations

Let $I \subset \mathbb{R}$ be an open interval and $f : I \times \mathbb{R} \rightarrow \mathbb{R}$ a continuous function. An equation of the form

$$y' = f(t, y) \quad \text{or} \quad y' = f(x, y) \quad \text{or} \quad \dot{y} = f(t, y) \quad (7.1)$$

is called a first order differential equation. $y = y(t)$ is said to be a solution of $y' = f(t, y)$ on the interval I if $y(t) \in C^1(I)$ is such that

$$\frac{dy(t)}{dt} = f(t, y(t))$$

In the differential equation (7.1) we call y the dependent variable and t the independent variable.

Geometric interpretation. Let $\mathbf{v} : I \times \mathbb{R} \rightarrow \mathbb{R}^2$ be a continuous vector field defined as

$$\mathbf{v}(t, y) = \begin{pmatrix} 1 \\ f(t, y) \end{pmatrix}$$

The graph of a solution $y(t)$ defines a curve $\mathbf{k} : I \rightarrow \mathbb{R}^2$ of class $C^1(I)$

$$\mathbf{k}(t) = \begin{pmatrix} t \\ y(t) \end{pmatrix}$$

This curve is tangent to the vector field \mathbf{v} since

$$\frac{d\mathbf{k}(t)}{dt} = \mathbf{v}(t, y(t)).$$

We call such a curve an integral curve of the vector field \mathbf{v} .

Cauchy problem. By searching for an integral curve containing the point (t_0, y_0) we are searching for a solution to the Cauchy problem

$$y' = f(t, y) \quad \text{and} \quad y(t_0) = y_0. \quad (7.2)$$

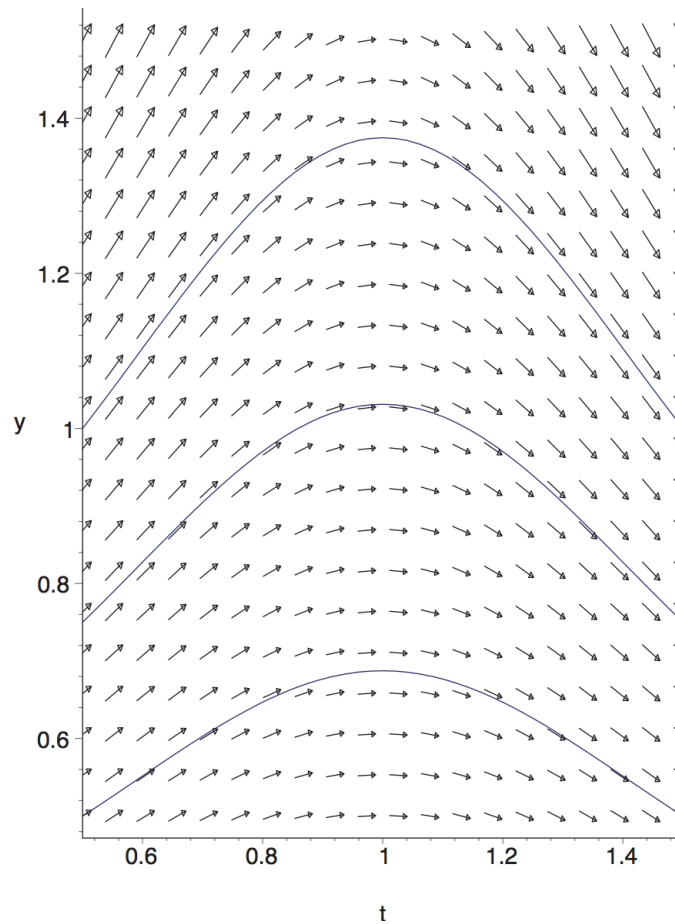

$\mathbf{v}(t, y)$ and its integral curves.

The equation

$$y'' = f(t, y, y') \quad (7.3)$$

is called a second order differential equation where $f : I \times \mathbb{R}^2 \rightarrow \mathbb{R}$. In mechanics, Newton's law $F = ma$, which describes the one dimensional motion of a particle of mass m under the influence of the force F , is a second order differential equation. t represents time, $y(t)$ the position of the mass m at time t , $v(t) = y'(t)$ its velocity and $a(t) = y''(t)$ its acceleration. The force $F = f(t, y, y')$ can depend on three variables t, y, y' . In mechanics derivatives with respect to time t are often denoted as \dot{y}, \ddot{y} etc. There are many examples of differential equations in other areas of physics, for example, in electricity the equation

$$L\ddot{y} + R\dot{y} + C^{-1}y = 0$$

describes the dynamics of a circuit of resistance R , capacitance C and inductance L , where $y(t)$ is the charge. It is the equation of a harmonic oscillator (with friction and without exterior forces).

$y = y(t)$ is said to be a solution of $y'' = f(t, y, y')$ on the interval I if $y(t) \in C^2(I)$ is such that

$$\frac{d^2 y(t)}{dt^2} = f\left(t, y(t), \frac{dy(t)}{dt}\right).$$

The Cauchy problem for the equation $y'' = f(t, y, y')$ is given by

$$y'' = f(t, y, y') \quad \text{and} \quad y(t_0) = y_0, \quad y'(t_0) = v_0. \quad (7.4)$$

In mechanics y_0 and v_0 represent the position, respectively the speed at time t_0 . For the equation $y'' = f(t, y, y')$ we can also set the boundary conditions, for example:

$$y'' = f(t, y, y') \quad \text{and} \quad y(t_0) = y_0, \quad y(t_1) = y_1. \quad (7.5)$$

If $f = f(t, y)$, this equation represents the equation of Euler-Lagrange for the Lagrangian

$$L = \frac{1}{2}y'^2 - F(t, y), \quad \frac{\partial F(t, y)}{\partial y} = f(t, y).$$

More generally, we call an equation of the form

$$y^{(n)} = f(t, y, y', \dots, y^{(n-1)})$$

an n 'th order differential equation. If $\mathbf{y} = \mathbf{y}(t) \in \mathbb{R}^n$ and $\mathbf{f} : I \times \mathbb{R}^n \rightarrow \mathbb{R}^n$ the equation

$$\mathbf{y}' = \mathbf{f}(t, \mathbf{y})$$

is called system of n (first order) differential equations. Any equation of order n can be written as a system of n differential equations. For example, if $n = 2$ we define

$$\mathbf{y} = \begin{pmatrix} y \\ y' \end{pmatrix}$$

and

$$\mathbf{f} = \mathbf{f}(t, \mathbf{y}) = \begin{pmatrix} y' \\ f(t, y, y') \end{pmatrix}.$$

If y is a solution of $y'' = f(t, y, y')$ then \mathbf{y} is a solution of

$$\mathbf{y}' = \mathbf{f}(t, \mathbf{y})$$

and vice versa. For example, the harmonic oscillator can be written as

$$\frac{d}{dt} \begin{pmatrix} y \\ y' \end{pmatrix} = \begin{pmatrix} 0 & 1 \\ -\frac{R}{L} & -\frac{1}{LC} \end{pmatrix} \begin{pmatrix} y \\ y' \end{pmatrix}$$

In practice the objective is to find an explicit solution to a differential equation and the Cauchy problem associated to it. It is often impossible and we must do a qualitative study of the problem and solve the problem numerically. To do such a study, one must first know that solutions to the problem exist. A fundamental mathematical result is the existence and uniqueness of the solution to the Cauchy problem

$$\mathbf{y}' = \mathbf{f}(t, \mathbf{y}) \quad \text{and} \quad \mathbf{y}(t_0) = \mathbf{y}_0$$

under certain fairly general hypotheses.

7.2 Existence and local uniqueness of solutions

First we transform the Cauchy problem for the system of differential equations to a system of integral equations.

Theorem - Integral equation. Let I be an interval, $t_0 \in \overset{\circ}{I}$, $D \subset \mathbb{R}^n$ and $\mathbf{f} : I \times D \rightarrow \mathbb{R}^n$ continuous. Then $\mathbf{y} : I \rightarrow \mathbb{R}^n$ is a solution of class C^1 of

$$\mathbf{y}' = \mathbf{f}(t, \mathbf{y}) \quad \text{and} \quad \mathbf{y}(t_0) = \mathbf{y}_0 \quad (7.6)$$

if and only if $\mathbf{y} : I \rightarrow \mathbb{R}^n$ is a continuous solution of the integral equation

$$\mathbf{y}(t) = \mathbf{y}_0 + \int_{t_0}^t \mathbf{f}(s, \mathbf{y}(s)) ds. \quad (7.7)$$

Proof. If $\mathbf{y} : I \rightarrow \mathbb{R}^n$ is a solution of class C^1 of (7.6), then by integrating the system of differential equations from t_0 to $t \in I$:

$$\int_{t_0}^t \mathbf{y}'(s) ds = \int_{t_0}^t \mathbf{f}(s, \mathbf{y}(s)) ds$$

that is to say

$$\mathbf{y}(t) - \mathbf{y}_0 = \int_{t_0}^t \mathbf{f}(s, \mathbf{y}(s)) ds.$$

If $\mathbf{y} : I \rightarrow \mathbb{R}^n$ is a continuous solution of the integral equation (7.7), then \mathbf{y} is of class C^1 since the right hand side of (7.7) is the indefinite integral of a continuous function (of the variable s), therefore it is C^1 . Taking the derivative of (7.7) with respect to t we obtain the differential equation system of (7.6). In addition, from the integral equation we get $\mathbf{y}(t_0) = \mathbf{y}_0$.

Definitions. Let $t_0 \in \mathbb{R}$, $\mathbf{y}_0 \in \mathbb{R}^n$. We define the closed "cylinder" $R_{a,b} \subset \mathbb{R}^{n+1}$ as

$$R_{a,b} := \left\{ \begin{pmatrix} t \\ \mathbf{y} \end{pmatrix} \in \mathbb{R}^{n+1} : |t - t_0| \leq a, \|\mathbf{y} - \mathbf{y}_0\|_2 \leq b \right\}$$

A continuous function $\mathbf{f} : R_{a,b} \rightarrow \mathbb{R}^n$ is said to be Lipschitz continuous in $R_{a,b}$ with respect to \mathbf{y} if there exists a constant $L > 0$ such that for any

$$\begin{pmatrix} t \\ \mathbf{y}_1 \end{pmatrix}, \begin{pmatrix} t \\ \mathbf{y}_2 \end{pmatrix} \in R_{a,b}:$$

$$\|\mathbf{f}(t, \mathbf{y}_2) - \mathbf{f}(t, \mathbf{y}_1)\|_2 \leq L \|\mathbf{y}_2 - \mathbf{y}_1\|_2. \quad (7.8)$$

Theorem - Existence and local uniqueness. Let $\mathbf{f} : R_{a,b} \rightarrow \mathbb{R}^n$ be Lipschitz continuous in $R_{a,b}$ with respect to \mathbf{y} . Let $M = M_{a,b} = \max\{\|\mathbf{f}(t, \mathbf{y})\|_2 : (t, \mathbf{y}) \in R_{a,b}\}$. Then, the Cauchy problem (7.6)

$$\mathbf{y}' = \mathbf{f}(t, \mathbf{y}) \quad \text{and} \quad \mathbf{y}(t_0) = \mathbf{y}_0 \quad (7.9)$$

has a unique solution $\mathbf{y} : [t_0 - \alpha, t_0 + \alpha] \rightarrow \mathbb{R}^n$, where $\alpha = \min(a, \frac{b}{M})$.

Remark - understanding α . The constant α gives a sufficient condition such that the solution $\mathbf{y}(t)$ remains in the cylinder $R_{a,b}$. In fact, from the triangle inequality (see Chapter 2) and the differential equation

$$\|\mathbf{y}(t) - \mathbf{y}_0\|_2 \leq \int_{[t_0, t]} \|\mathbf{y}'(s)\|_2 ds = \int_{[t_0, t]} \|\mathbf{f}(s, \mathbf{y}(s))\|_2 ds \leq M|t - t_0|,$$

if $M|t - t_0| \leq b$ and $|t - t_0| \leq a$, then $\mathbf{y}(t) \in R_{a,b}$. If $Ma \leq b$, $\alpha = a$ otherwise choose $\alpha = \frac{b}{M}$.

Proof. In $I := [t_0 - \alpha, t_0 + \alpha]$ consider $E = C^0(I)$ the space of continuous functions (curves) $\mathbf{y}(t) : I \rightarrow \mathbb{R}^n$ equipped with the norm

$$\|\mathbf{y}\|_E := \sup\{\|\mathbf{y}(t)\|_2 e^{-2L|t-t_0|} : t \in I\} = \max\{\|\mathbf{y}(t)\|_2 e^{-2L|t-t_0|} : t \in I\}.$$

Then $(E, \|\cdot\|_E)$ is a Banach space (the norm $\|\cdot\|_E$ is equivalent to the usual norm for uniform convergence, that is to say, without the exponential factor). Let F be the set of curves $\mathbf{y} \in E$ such that their graph is in $R_{a,b}$. Then $F \subset E$ is closed in \mathbb{R}^{n+1} . Consider the function $T : F \rightarrow E$ defined as

$$(T\mathbf{y})(t) := \mathbf{y}_0 + \int_{t_0}^t \mathbf{f}(s, \mathbf{y}(s)) ds.$$

Thanks to the estimation $\|(T\mathbf{y})(t) - \mathbf{y}_0\|_2 \leq M\alpha \leq b$, $T : F \rightarrow F$. Using

$$\begin{aligned} e^{-2L|t-t_0|} \|(T\mathbf{y})(t) - (T\mathbf{x})(t)\|_2 &\leq e^{-2L|t-t_0|} \int_{[t_0, t]} \|\mathbf{f}(s, \mathbf{y}(s)) - \mathbf{f}(s, \mathbf{x}(s))\|_2 ds \\ &\leq e^{-2L|t-t_0|} \int_{[t_0, t]} L \|\mathbf{y}(s) - \mathbf{x}(s)\|_2 ds \\ &= Le^{-2L|t-t_0|} \int_{[t_0, t]} e^{2L|s-t_0|} e^{-2L|s-t_0|} \|\mathbf{y}(s) - \mathbf{x}(s)\|_2 ds \\ &\leq Le^{-2L|t-t_0|} \|\mathbf{y} - \mathbf{x}\|_E \int_{[t_0, t]} e^{2L|s-t_0|} ds \\ &\leq Le^{-2L|t-t_0|} \|\mathbf{y} - \mathbf{x}\|_E \frac{e^{2L|t-t_0|} - 1}{2L} \\ &\leq \frac{1}{2} \|\mathbf{y} - \mathbf{x}\|_E \end{aligned}$$

and taking the maximum on the left hand side, we see that $T : F \rightarrow F$ is a contraction

$$\|T(\mathbf{y}) - T(\mathbf{x})\|_E \leq \frac{1}{2} \|\mathbf{y} - \mathbf{x}\|_E.$$

Thus T has a unique fixed point $\mathbf{y} = \mathbf{y}(t)$ in F :

$$\mathbf{y}(t) = (T\mathbf{y})(t) := \mathbf{y}_0 + \int_{t_0}^t \mathbf{f}(s, \mathbf{y}(s)) ds.$$

Locally Lipschitz continuous functions. Let I be an interval, $D \subset \mathbb{R}^n$. A continuous function $\mathbf{f} : I \times D \rightarrow \mathbb{R}^n$ is called locally Lipschitz continuous

with respect to \mathbf{y} in $I \times D$ if for any $t_0 \in \overset{\circ}{I}$, $\mathbf{y}_0 \in \overset{\circ}{D}$ there exists a cylinder $R_{a,b} \subset I \times D$ and a constant $L := L(t_0, \mathbf{y}_0) > 0$ such that

$$\|\mathbf{f}(t, \mathbf{y}_2) - \mathbf{f}(t, \mathbf{y}_1)\|_2 \leq L \|\mathbf{y}_2 - \mathbf{y}_1\|_2$$

in $R_{a,b}$. A continuous function $\mathbf{f} : I \times D \rightarrow \mathbb{R}^n$ such that the partial derivatives $\frac{\partial f_i(t, \mathbf{y})}{\partial y_j}$ are continuous for all $1 \leq i, j \leq n$ is always Lipschitz continuous with respect to \mathbf{y} . In fact, from the composition rule

$$\begin{aligned} \mathbf{f}(t, \mathbf{y}_2) - \mathbf{f}(t, \mathbf{y}_1) &= \int_0^1 \frac{d}{d\sigma} \mathbf{f}(t, \sigma \mathbf{y}_2 + (1 - \sigma) \mathbf{y}_1) d\sigma \\ &= \int_0^1 J_{\mathbf{f}}^{\mathbf{y}}(t, \sigma \mathbf{y}_2 + (1 - \sigma) \mathbf{y}_1) (\mathbf{y}_2 - \mathbf{y}_1) d\sigma \end{aligned}$$

where $J_{\mathbf{f}}^{\mathbf{y}}$ is the $n \times n$ matrix containing the partial derivatives $\frac{\partial f_i(t, \mathbf{y})}{\partial y_j}$. It follows from the continuity of these partial derivatives that

$$\|\mathbf{f}(t, \mathbf{y}_2) - \mathbf{f}(t, \mathbf{y}_1)\|_2 \leq \int_0^1 \|J_{\mathbf{f}}^{\mathbf{y}}(t, \sigma \mathbf{y}_2 + (1 - \sigma) \mathbf{y}_1)\|_2 d\sigma \|\mathbf{y}_2 - \mathbf{y}_1\|_2 \leq L \|\mathbf{y}_2 - \mathbf{y}_1\|_2$$

with $L = \max\{\|J_{\mathbf{f}}^{\mathbf{y}}(t, \mathbf{y})\|_2 : (t, \mathbf{y}) \text{ in } R_{a,b}\}$. For example, the function $f := [0, 1] \times]0, \infty[\rightarrow \mathbb{R}$ defined as $f(t, y) = \frac{t}{y}$ is locally Lipschitz continuous with respect to y . It is not Lipschitz continuous with respect to y for $y \in]0, \infty[$.

Corollary. Let $\mathbf{f} : I \times D \rightarrow \mathbb{R}^n$ be locally Lipschitz continuous with respect to \mathbf{y} in $I \times D$. Then for any $t_0 \in \overset{\circ}{I}$, $\mathbf{y}_0 \in \overset{\circ}{D}$ there exists an interval J such that the Cauchy problem has a unique solution in J .

Other properties. The solution $\mathbf{y}(t)$ to the Cauchy problem depends on the initial conditions t_0, \mathbf{y}_0 . Hence we can write $\mathbf{y} = \mathbf{y}(t, t_0, \mathbf{y}_0)$. With an argument of the type "fixed point" we can prove that \mathbf{y} is continuous in t_0 and \mathbf{y}_0 . Similarly, if the function \mathbf{f} is a continuous function of a parameter λ : $\mathbf{f} = \mathbf{f}(t, \mathbf{y}, \lambda)$, then the solution $\mathbf{y}(t, \lambda)$ is continuous at λ .

7.3 Solving certain first order differential equations

7.3.1 $y' = f(t)$

The general solution of

$$y' = f(t)$$

for a continuous function $f : I \rightarrow \mathbb{R}$ is given by the family of antiderivatives of $f(t)$:

$$y(t) = \int^t f(s) ds + C, \quad C \in \mathbb{R}.$$

The Cauchy problem

$$y' = f(t) \quad \text{and} \quad y(t_0) = y_0$$

has a unique solution given by

$$\int_{t_0}^t y'(s) ds = \int_{t_0}^t f(s) ds$$

i.e.

$$y(t) = \int_{t_0}^t f(s) ds + y(t_0).$$

Examples.

1. The general solution of

$$y' = 2 \sin t \cos t$$

is given by

$$y(t) = \sin^2 t + C, \quad C \in \mathbb{R}.$$

2. Consider

$$y' = \frac{2}{1-t^2}$$

on $I =]-1, 1[$. The solution to the Cauchy problem with $y(-0.5) = 3$ is given by

$$\int_{-0.5}^t y'(s) ds = \int_{-0.5}^t \frac{2}{1-s^2} ds = \int_{-0.5}^t \frac{1}{1+s} + \frac{1}{1-s} ds$$

i.e.

$$y(t) = \ln(1+t) - \ln(1-t) - (\ln 1/2 - \ln 3/2) + 3 = \ln \frac{1+t}{1-t} + \ln 3 + 3.$$

Note as well that

$$\ln \frac{1+t}{1-t} = 2 \operatorname{arctanh} t.$$

7.3.2 $y'(x) + a(x)y(x) = b(x)$

Finding solutions to the linear equation $y'(x) + a(x)y(x) = b(x)$. Let $a, b : I \rightarrow \mathbb{R}$ be continuous. To solve the homogeneous linear equation (i.e. $b(x) \equiv 0$)

$$y'(x) + a(x)y(x) = 0$$

we define

$$u(x) = e^{A(x)}y(x)$$

where $A(x)$ is an antiderivative of $a(x)$, i.e. $A'(x) = a(x)$. The function $u(x)$ satisfies

$$u'(x) = e^{A(x)}(y'(x) + a(x)y(x)) = 0.$$

Therefore $u(x) = c$ for a constant $c \in \mathbb{R}$ and $y(x) = ce^{-A(x)}$ is the general solution of the homogeneous linear equation. To find a particular solution of the inhomogeneous linear equation note that $u(x)$ satisfies

$$u'(x) = b(x)e^{A(x)}.$$

Therefore

$$u(x) = \int_{x_0}^x b(s)e^{A(s)} ds = \int_{x_0}^x b(s)e^{A(s)} ds + c.$$

for an $x_0 \in \mathbb{R}$, i.e.

$$y(x) = ce^{-A(x)} + e^{-A(x)} \int_{x_0}^x b(s)e^{A(s)} ds.$$

Formulas for the linear equation. General solution:

$$y(x) = ce^{-A(x)} + e^{-A(x)} \int_{x_0}^x b(s)e^{A(s)} ds, \quad A'(x) = a(x).$$

Solution to the Cauchy problem $y(x_0) = y_0$:

$$y(x) = y_0e^{A(x_0)-A(x)} + e^{-A(x)} \int_{x_0}^x b(s)e^{A(s)} ds, \quad A'(x) = a(x).$$

Note that there always exists a unique solution to the Cauchy problem.

General properties.

1. Let $y_1(x), y_2(x)$ be two solutions of the homogeneous equation $y'(x) + a(x)y(x) = 0$. Then any linear combination $\alpha y_1(x) + \beta y_2(x)$ of $y_1(x), y_2(x)$ is also a solution of the homogeneous equation.
2. Let $z_1(x), z_2(x)$ be two solutions of the inhomogeneous equation $y'(x) + a(x)y(x) = b(x)$. Then $z_1(x) - z_2(x)$ is a solution of the homogeneous equation. Or if $z(x)$ is a solution of the non-homogeneous equation, then $y(x) + z(x)$ is a solution of the inhomogeneous equation. That is why the general solution of the non-homogeneous equation is written as the sum of the general solution of the homogeneous equation and of a particular solution of the inhomogeneous equation.

Variation of constants method. A useful method to find a particular solution of the inhomogeneous equation is to replace the constant c in the general solution $y(x) = c e^{-A(x)}$ by a function $c(x)$ and to insert this ansatz in the inhomogeneous equation. We find

$$(c(x) e^{-A(x)})' + a(x)c(x) e^{-A(x)} = b(x)$$

and finally

$$c'(x) = b(x)e^{A(x)}$$

Example. Give the general solution of

$$y' + \frac{t}{1+t^2}y = \frac{t}{(1+t^2)^2}$$

Note that $A(t) = \frac{1}{2} \ln(1+t^2)$. Consequently, the general solution of the homogeneous equation is of the form

$$c e^{-A(t)} = \frac{c}{\sqrt{1+t^2}}, \quad c \in \mathbb{R}.$$

A particular solution of the nonhomogeneous equation is given by

$$e^{-A(t)} \int_0^t b(s)e^{A(s)} ds = \frac{1}{\sqrt{1+t^2}} \int_0^t \frac{s}{(1+t^2)^{3/2}} = \frac{-1}{1+t^2}.$$

Hence, the general solution is of the form

$$y(t) = \frac{c}{\sqrt{1+t^2}} - \frac{1}{1+t^2}, \quad c \in \mathbb{R}.$$

7.3.3 $y' = f(y)$

This equation is called an autonomous differential equation since the function f does not depend on the independent variable t . The autonomous differential equation remains invariant under translation in the variable t , i.e. if $y(t)$ is a solution of $y' = f(y)$ then $y(t+s)$ is a solution of $y' = f(y)$ for any fixed real number s . If y_0 is such that $f(y_0) = 0$, then the constant function $y(t) = y_0$ is a solution of the differential equation $y' = f(y)$. Such a solution is called a stationary solution or a stationary point.

Solutions of the autonomous equation. Consider the Cauchy problem

$$y' = f(y), \quad y(t_0) = y_0$$

for a continuous function F such that $f(y_0) \neq 0$ (i.e. y_0 is not a stationary solution). Let F be a primitive integral of the function $1/f$, i.e.

$$\frac{dF(y)}{dy} = \frac{1}{f(y)}$$

then, the unique solution of the Cauchy problem $y(t)$ satisfies the relation

$$F(y(t)) - F(y_0) = t - t_0.$$

Next we must solve this equation for $y(t)$. Note that F is locally invertible around y_0 since $\frac{dF(y)}{dy}|_{y=y_0} = \frac{1}{f(y_0)} \neq 0$. Consequently, in a neighborhood of t_0 we have

$$y(x) = F^{-1}(F(y_0) + t - t_0).$$

Remark. The solution $y(t)$ is unique for any x such that $f(y(x)) \neq 0$. Indeed, if $z(t)$ is another solution such that $f(z(x)) \neq 0$, then $F(z(t)) = F(y(t))$ since

$$\frac{dF(z(t))}{dt} = \frac{z'(t)}{f(z(t))} = 1 = \frac{y'(t)}{f(y(t))} = \frac{dF(y(t))}{dt}$$

and $F(z(t_0)) = F(y(t_0))$. From the mean value theorem there exists $c = c(t)$ between $y(t)$ and $z(t)$ such that $f(c(t)) \neq 0$ and

$$0 = F(z(t)) - F(y(t)) = \frac{1}{f(c(t))} (z(t) - y(t))$$

i.e. $z(t) = y(t)$.

Remark. The condition $f(y_0) \neq 0$ is necessary and sufficient for uniqueness of the solution to the Cauchy problem. For example,

$$y' = 2\sqrt{|y|}, \quad y(0) = 0$$

has two distinct solutions $y_1(t) = 0$ and $y_2(t) = t^2$. To guarantee the uniqueness of stationary solutions f must satisfy stronger hypotheses: A sufficient condition is that f must be Lipschitz continuous on an interval around the initial condition.

Remark. Formally we can write the differential equation $\frac{dy}{dt} = f(y)$ as

$$dy = f(y) dt \quad \text{or} \quad \frac{dy}{f(y)} = dt$$

and we integrate to get

$$\int_{y_0}^y \frac{d\eta}{f(\eta)} d\eta = \int_{t_0}^t d\xi$$

i.e.

$$F(y) - F(y_0) = t - t_0.$$

Example. Give the solution of the Cauchy problem

$$y' = 1 - y^2, \quad y(1) = 0.$$

We have

$$\int_0^y \frac{d\eta}{1 - \eta^2} d\eta = \int_1^t d\xi$$

where

$$\operatorname{arctanh} y(t) = t - 1 \quad \text{i.e.} \quad y(t) = \tanh(t - 1)$$

7.3.4 Variable substitution technique

We can transform the differential equation $y' = f(t, y)$ through the application $(t, y) \mapsto (s, u)$ where $s = s(t, y)$ and $u = h(t, y)$. In the following we will present a few examples:

Transformation of an autonomous equation. The variable substitution

$$s = s(t), \quad y(t) = a(t)u(s), \quad a'(t), a(t) > 0,$$

allows to transform the differential equation

$$y' = a'(t)f(y(t)/a(t))$$

by $y'(t) = a'(t)u(s) + a(t)s'(t)\dot{u}(s)$ with $\dot{u}(s) = \frac{du(s)}{ds}$ into the differential equation

$$a(t)s'(t)\dot{u}(s) = a'(t)f(u(s)) - a'(t)u(s).$$

This becomes an autonomous equation if $s(t) = \ln a(t)$.

Riccati equation. There are transformations that give second order differential equations. To find the general solution of

$$y' = -y^2 + q(x)$$

we set $y = \frac{u'}{u}$, $u > 0$. We obtain

$$u'' = q(x)u$$

Autonomous systems - an equation for orbits in phase space. Consider the autonomous system

$$\dot{x} = -g(x, y), \quad \dot{y} = f(x, y) \tag{7.10}$$

If we cannot solve this system we can formulate a first order differential equation considering y as a function of x . By setting $y(t) = Y(x(t))$ we get

$$f(x, Y(x)) = \dot{y} = \frac{dY}{dx}\dot{x} = -\frac{dY}{dx}g(x, Y(x)).$$

This is (for convenience we keep using the notation y instead of Y) a first order differential equation:

$$f(x, y) + g(x, y)\frac{dy}{dx} = 0, \quad \text{or} \quad \frac{dy}{dx} = -\frac{f(x, y)}{g(x, y)}.$$

7.3.5 Exact differential equations

The most general form of a differential equation is $f(x, y, y') = 0$, called implicit differential equation. A particular case is given by differential equations of the form $f(x, y) + g(x, y)y' = 0$, for which we, under certain conditions, can find solutions given by an equation of the form $H(x, y(x)) = 0$. In fact, if $D \subset \mathbb{R}^2$ and $H : D \rightarrow \mathbb{R}$ is of class C^1 , then for any $(t_0, x_0) \in \overset{\circ}{D}$ a solution of the Cauchy problem

$$\frac{\partial H(x, y)}{\partial x} + \frac{\partial H(x, y)}{\partial y} y' = 0, \quad y(x_0) = y_0$$

is given by the equation $H(x, y(x)) = H(x_0, y_0)$.

Exact differential equation. Let $D =: [a, b] \times [c, d]$ and $f, g : D \rightarrow \mathbb{R}$ of class C^1 . The differential equation

$$f(x, y) + g(x, y)y' = 0 \quad (7.11)$$

is said to be exact if

$$\frac{\partial f(x, y)}{\partial y} = \frac{\partial g(x, y)}{\partial x} \quad (7.12)$$

In this case there exists $H : D \rightarrow \mathbb{R}$ of class C^2 given by (See exercise 27, Chapter 6)

$$H(x, y) = \int_0^1 f(x_t, y_t)(x - x_0) + g(x_t, y_t)(y - y_0) dt + \text{const.} \quad (7.13)$$

where $(x_t, y_t) = (tx + (1-t)x_0, ty + (1-t)y_0) \in \overset{\circ}{D}$. Alternatively, we can find a function $H(x, y)$ as follows: Let

$$F(x, y) = \int_{x_0}^x f(z, y) dz$$

therefore $\frac{\partial F(x, y)}{\partial x} = f(x, y)$. We set $H(x, y) = F(x, y) + K(y)$. Of course $\frac{\partial H(x, y)}{\partial x} = f(x, y)$ and $\frac{\partial H(x, y)}{\partial y} = g(x, y)$ imply that $K'(y) = g(x, y) - \frac{\partial F(x, y)}{\partial y}$. The right hand side is indeed independent of x (this justifies our choice of H) since

$$\frac{\partial}{\partial x} \left(g(x, y) - \frac{\partial F(x, y)}{\partial y} \right) = \frac{\partial g(x, y)}{\partial x} - \frac{\partial f(x, y)}{\partial x} = 0.$$

We must solve an autonomous differential equation for K .

Application to autonomous systems. If the functions f and g verify the condition (7.12) the autonomous system (7.10) can be written like a "Hamiltonian" system

$$\dot{x} = -\frac{\partial H(x, y)}{\partial y}, \quad \dot{y} = \frac{\partial H(x, y)}{\partial x}. \quad (7.14)$$

If $(x(t), y(t))$ is a solution of (7.14), then $H(x(t), y(t)) = \text{const.}$ can be interpreted as the conservation of the "energy $H(x, y)$ ". If we identify the system (7.14) with a mechanical system (movement of a particle in one dimension), then x corresponds to the momentum and y corresponds to the position (see also section 7.4.5).

Integrating factor. If the differential equation (7.11) is not exact, we can in certain cases multiply (7.11) by a function $\lambda(x, y)$ (called the integrating factor) which renders (7.11) exact, in other words

$$\frac{\partial(\lambda(x, y)f(x, y))}{\partial y} = \frac{\partial(\lambda(x, y)g(x, y))}{\partial x}.$$

For example, the inhomogeneous linear differential equation $y' + a(x)y - b(x) = 0$ is not exact ($g(x, y) = 1, f(x, y) = a(x)y - b(x)$). An integrating factor is $\lambda(x) = e^{A(x)}$, $A' = a$. We find $H(x, y) = e^{A(x)}y - k(x)$ where $k'(x) = b(x)e^{A(x)}$.

7.4 Differential equations of order two

7.4.1 Linear homogenous equations - general properties

Let $p, q : I \rightarrow \mathbb{R}$ be continuous. We call an equation of the type

$$y''(t) + p(t)y'(t) + q(t)y(t) = 0. \quad (7.15)$$

a linear homogenous differential equation of order two.

With the exception of a few particular cases we can not give any explicit solutions to equations of this type.

Proposition. Let $y_1(t), y_2(t)$ be two solutions of (7.3). Then, for any $\alpha, \beta \in \mathbb{R}$ the linear combination $\alpha y_1(t) + \beta y_2(t)$ is also a solution of (7.3).

Proposition. The Cauchy problem for the linear homogenous differential equation of order two, i.e.

$$y''(t) + p(t)y'(t) + q(t)y(t) = 0, \quad \text{and} \quad y(t_0) = y_0, y_0'(t_0) = v_0$$

admits a unique solution for every couple $(y_0, v_0) \in \mathbb{R}^2$.

Definition. The two functions $y_1, y_2 : I \rightarrow \mathbb{R}$ are said linearly independent if

$$(\alpha y_1(t) + \beta y_2(t) = 0 \quad \text{for all } t \in I) \Rightarrow \alpha = \beta = 0$$

Definition. Let $y_1, y_2 : I \rightarrow \mathbb{R}$ be two functions of class $C^1(I)$. We call the Wronskian of y_1, y_2 the function $w : I \rightarrow \mathbb{R}$ defined by

$$w(t) = y_1(t)y_2'(t) - y_1'(t)y_2(t).$$

Proposition. Let $y_1(t), y_2(t)$ be two solutions (7.3). Then, the Wronskian of y_1, y_2 is given by

$$w(t) = w(t_0) \exp\left(-\int_{t_0}^t p(s) ds\right).$$

Proof. $w'(t) = y_1(t)y_2''(t) - y_1''(t)y_2(t) = -p(t)w(t)$.

Remark. Consequently we have the following alternative: either the Wronskian is always zero on I or it is never zero on I .

Proposition. Two solutions $y_1(t), y_2(t)$ of (7.3) are linearly independent if and only if their Wronskian is non zero.

Proposition. Equation (7.3) admits two linearly independent solutions $y_1(t), y_2(t)$ and every solution $y(t)$ of (7.3) is of the form

$$y(t) = c_1 y_1(t) + c_2 y_2(t)$$

where c_1 and c_2 are constants.

Remark. To find the unique solution of the Cauchy problem starting from a general solution we resolve the system of linear equations

$$y_0 = c_1 y_1(t_0) + c_2 y_2(t_0) \quad v_0 = c_1 y_1'(t_0) + c_2 y_2'(t_0)$$

for c_1 and c_2 .

Remark. If we have a solution $y_1(t)$ of (7.3) we can find another solution $y_2(t)$ that is linearly independent with $y_1(t)$ with the Wronskian: for a $t_0 \in I$ we set $w(t_0) = 1$ and we solve the relation

$$w(t) = \exp\left(-\int_{t_0}^t p(s) ds\right)$$

for $y_2(t)$ by using that

$$w(t) = y_1(t)y_2'(t) - y_1'(t)y_2(t) = y_1^2(t) \left(\frac{y_2(t)}{y_1(t)}\right)'$$

Therefore, another solution $y_2(t)$ is given by

$$y_2(t) = y_1(t) \int_{t_0}^t \frac{w(s)}{y_1^2(s)} ds = y_1(t) \int_{t_0}^t \frac{e^{-\int_{t_0}^s p(\tau) d\tau}}{y_1^2(s)} ds$$

Interpretation as a system of equations of order 1. The notions "linearly independent" and the Wronskian are more intuitive for the system of equations of order 1 associated to (7.3):

$$\frac{d}{dt} \begin{pmatrix} y \\ y' \end{pmatrix} = \begin{pmatrix} 0 & 1 \\ -q(t) & -p(t) \end{pmatrix} \begin{pmatrix} y \\ y' \end{pmatrix} \quad (7.16)$$

Two solutions are said linearly independent if the vectors $\mathbf{y}_1(t) = \begin{pmatrix} y_1(t) \\ y_1'(t) \end{pmatrix}$, $\mathbf{y}_2(t) = \begin{pmatrix} y_2(t) \\ y_2'(t) \end{pmatrix}$ are two linearly independent vector for any $t \in I$. The Wronskian is the determinant of the matrix formed by the two vectors $\mathbf{y}_1(t), \mathbf{y}_2(t)$:

$$w(t) = \det \begin{pmatrix} y_1(t) & y_2(t) \\ y_1'(t) & y_2'(t) \end{pmatrix}$$

The Wronskian gives the area (more precisely the oriented area since the Wronskian can be positive or negative) of the parallelogram

$$D(t) = \{\alpha \mathbf{y}_1(t) + \beta \mathbf{y}_2(t), 0 \leq \alpha \leq 1, 0 \leq \beta \leq 1\}.$$

By the results above the vectors $\mathbf{y}_1(t), \mathbf{y}_2(t)$ are linearly independent for any $t \in I$ if and only if $\mathbf{y}_1(t_0), \mathbf{y}_2(t_0)$ are linearly independent for a $t_0 \in I$. Consequently, the solutions of the system (7.4) form a vector space of dimension 2.

7.4.2 Homogeneous linear equations with constant coefficients

Consider

$$y''(t) + p y'(t) + q y(t) = 0 \quad \text{with } p, q \in \mathbb{R}. \quad (7.17)$$

We check if $y(t) = \exp(\lambda t)$ is a solution for a given λ . We find that λ must be a root of the characteristic polynomial associated with the matrix

$$A = \begin{pmatrix} 0 & 1 \\ -q & -p \end{pmatrix}$$

i.e.

$$\lambda^2 + p \lambda + q = 0.$$

Note that the roots give the eigenvalues λ_1, λ_2 of the matrix A . We distinguish the following cases:

Two distinct real eigenvalues. $\lambda_1, \lambda_2 \in \mathbb{R}$ and $\lambda_1 \neq \lambda_2$. The general solution is given by

$$y(t) = c_1 e^{\lambda_1 t} + c_2 e^{\lambda_2 t}$$

Two distinct conjugated complex eigenvalues. $\lambda_1 = \mu + i\omega, \lambda_2 = \mu - i\omega$, $\mu, \omega \in \mathbb{R}, \omega \neq 0$. The exponential functions are complex-valued solutions. To obtain real-valued solutions note that the imaginary part and the real part are solutions as well. The general solution is given by

$$y(t) = c_1 e^{\mu t} \cos(\omega t) + c_2 e^{\mu t} \sin(\omega t)$$

A double real eigenvalue. $\lambda_1 = \lambda_2 = \lambda \in \mathbb{R}$. We find a second solution using the Wronskian formula given by $te^{\lambda t}$. The general solution is given by

$$y(t) = c_1 e^{\lambda t} + c_2 t e^{\lambda t} = (c_1 + c_2 t) e^{\lambda t}$$

7.4.3 Inhomogeneous linear equations

Let $p, q, f : I \rightarrow \mathbb{R}$ be continuous. We call an equation of the form

$$y''(t) + p(t)y'(t) + q(t)y(t) = f(t). \quad (7.18)$$

an inhomogeneous second order linear differential equation.

Proposition. A solution $y(t)$ of (7.6) is of the form

$$y(t) = c_1 y_1(t) + c_2 y_2(t) + y_p(t)$$

where $y_1(t), y_2(t)$ are two linearly independent solutions of the associated homogeneous equation and $y_p(t)$ is a particular solution of (7.6).

Construction of a particular solution in the general case. Let $y_1(t), y_2(t)$ be two linearly independent solutions of the homogeneous equation (7.3) and $w(t) = y_1(t)y_2'(t) - y_1'(t)y_2(t)$ its Wronskian. We define the function $k : I \times I \rightarrow \mathbb{R}$ as

$$k(s, t) = \frac{y_1(s)y_2'(t) - y_1'(s)y_2(t)}{y_1(s)y_2'(s) - y_1'(s)y_2(s)} = \frac{y_1(s)y_2'(t) - y_1'(t)y_2(s)}{w(s)}.$$

Proposition. A particular solution $y_p(t)$ of (7.6) is given by

$$y_p(t) = \int_{t_0}^t k(s, t) f(s) ds$$

Proof. Note that $k(t, t) = 0$, we have

$$y_p'(t) = k(t, t) f(t) + \int_{t_0}^t D_t k(s, t) f(s) ds = \int_{t_0}^t D_t k(s, t) f(s) ds$$

and

$$y_p''(t) = D_t k(t, t) f(t) + \int_{t_0}^t D_{tt} k(s, t) f(s) ds.$$

Therefore,

$$y_p''(t) + p(t)y_p'(t) + q(t)y_p(t) = D_t k(t, t) f(t) + \int_{t_0}^t \left(D_{tt} k(s, t) + p(t)D_t k(s, t) + q(t)k(s, t) \right) f(s) ds.$$

Using

$$D_t k(s, t) = \frac{y_1(s)y_2'(t) - y_1'(t)y_2(s)}{w(s)}$$

and

$$D_{tt} k(s, t) = \frac{y_1(s)y_2''(t) - y_1''(t)y_2(s)}{w(s)}$$

we see that

$$D_t k(t, t) = \frac{y_1(t)y_2'(t) - y_1'(t)y_2(t)}{w(t)} = 1$$

and

$$D_{tt} k(s, t) + p(t)D_t k(s, t) + q(t)k(s, t) = 0,$$

hence $y_p(t)$ is a particular solution of (7.6).

Remark. Even though this is a general method there are often more efficient techniques for finding a particular solution.

7.4.4 Non-homogeneous linear equations with constant coefficients

Let $f : I \rightarrow \mathbb{R}$ be continuous. Consider

$$y''(t) + p y'(t) + q y(t) = f(t). \quad (7.19)$$

with $p, q \in \mathbb{R}$. Let us calculate $k(s, t)$:

Two distinct real eigenvalues. $\lambda_1, \lambda_2 \in \mathbb{R}$ and $\lambda_1 \neq \lambda_2$.

$$k(s, t) = \frac{e^{\lambda_2(t-s)} - e^{\lambda_1(t-s)}}{\lambda_2 - \lambda_1}$$

Two distinct complex conjugated eigenvalues. $\lambda_1 = \mu + i\omega, \lambda_2 = \mu - i\omega, \mu, \omega \in \mathbb{R}, \omega \neq 0$. It is easier to calculate $k(s, t)$ using the complex solutions:

$$k(s, t) = e^{\mu(t-s)} \frac{e^{i\omega(t-s)} - e^{-i\omega(t-s)}}{2i\omega} = e^{\mu(t-s)} \frac{\sin \omega(t-s)}{\omega}$$

A double real eigenvalue. $\lambda_1 = \lambda_2 = \lambda \in \mathbb{R}$. Then

$$k(s, t) = (t-s)e^{\lambda(t-s)}$$

Example. Solve the Cauchy problem

$$y''(t) + p y'(t) = -g, \quad \text{and} \quad y(0) = h, y'_0(0) = 0$$

where $g > 0$. This problem describes free fall with air resistance ($p > 0$) from a height h .

Application of the general method. The eigenvalues are 0 and $-p$, therefore $y_1(t) = e^{-pt}$ and $y_2(t) = 1$ are two linearly independent solutions of the homogeneous equation. We have

$$k(s, t) = \frac{1 - e^{-p(t-s)}}{p}$$

and

$$y_p(t) = -g \int_0^t k(s, t) ds = g \frac{1 - pt - e^{-pt}}{p^2}$$

We deduce that $y_p(0) = 0$ and $y'_p(0) = 0$. Therefore

$$y(t) = h + y_p(t)$$

is a solution of the Cauchy problem.

Alternative method. The equation is of first order for y' . From 7.2.2

$$y'(t) = -g \frac{1 - e^{-pt}}{p}$$

is a particular solution and after integrating $y(t) = h + y_p(t)$.

Equations with $\mathbf{f}(t) = \mathbf{E} \sin(\omega t)$ or $\mathbf{f}(t) = \mathbf{E} \cos(\omega t)$. To find a particular solution of (7.7) where (i) $f(t) = E \sin(\omega t)$ or (ii) $f(t) = E \cos(\omega t)$ we pass to complex numbers and search for a particular solution $z_p : \mathbb{R} \rightarrow \mathbb{C}$ of

$$z'' + pz' + qz = Ee^{i\omega t}.$$

Next we take $y_p = \text{Im}z_p$ in case (i) and $y_p = \text{Re}z_p$ in case (ii). We try the Ansatz $z = Ae^{i\omega t}$, $A \in \mathbb{C}$. When inserted in the differential equation it gives the condition

$$(-\omega^2 + ip\omega + q)Ae^{i\omega t} = Ee^{i\omega t}.$$

If $-\omega^2 + ip\omega + q \neq 0$ the solution is given by $A = \frac{E}{-\omega^2 + ip\omega + q}$ and consequently

$$z_p(t) = \frac{E}{-\omega^2 + ip\omega + q} e^{i\omega t}.$$

Example. Find a particular solution of

$$y''(t) + 2y'(t) + y(t) = E \sin(\omega t)$$

where $E > 0$, $\omega \neq 0$. We find the condition

$$A = \frac{E}{1 - \omega^2 + 2i\omega} = \frac{E(1 - \omega^2 - 2i\omega)}{(1 + \omega^2)^2}$$

Therefore,

$$y_p(t) = \text{Im}(A e^{i\omega t}) = E \frac{(1 - \omega^2) \sin(\omega t) - 2\omega \cos(\omega t)}{(1 + \omega^2)^2}$$

Example. Find a particular solution of

$$y''(t) + \omega_0^2 y(t) = E \sin(\omega t).$$

If $\omega^2 \neq \omega_0^2$, then

$$y_p(t) = \text{Im}\left(\frac{E}{-\omega^2 + \omega_0^2} e^{i\omega t}\right) = \frac{E \sin \omega t}{\omega_0^2 - \omega^2}.$$

If $\omega^2 = \omega_0^2$, we do an Ansatz of the variation of constants method $z(t) = A(t)e^{i\omega t}$ and find $A(t) = \frac{-iEt}{2\omega}$, therefore

$$y_p(t) = \text{Im}\left(\frac{-iEt}{2\omega} e^{i\omega t}\right) = \frac{-iEt \cos(\omega t)}{2\omega} = \frac{-iEt \sin(\omega t + \frac{\pi}{2})}{2\omega}.$$

The "phase" $\frac{\pi}{2}$ indicates the delay of the system.

7.4.5 Autonomous equations and conservative systems

Let $f : \mathbb{R}^2 \rightarrow \mathbb{R}$ be continuous. We call autonomous differential equation of order two an equation of the form

$$\ddot{y}(t) = -f(y(t), \dot{y}(t)).$$

This differential equation also has the property of being invariant under translation in t , i.e. if $y(t)$ is a solution then $y(t + s)$ is a solution for any real fixed s . If the function f does not depend on y' , i.e. $f = f(y)$ we call this equation conservative. By introducing a parameter $m > 0$ (the mass of the particle) the associated Cauchy problem is

$$m\ddot{y}(t) = -f(y) \quad \text{and} \quad y(t_0) = y_0, \dot{y}(t)(t_0) = v_0 \quad (7.20)$$

Definition. Let F be a primitive integral of f and $E : \mathbb{R}^2 \rightarrow \mathbb{R}$ be defined by

$$E(y, p) = \frac{1}{2m} p^2 + F(y)$$

If $y(t)$ is a solution of (7.20) we call $E(y(t), m\dot{y}(t))$ the energy of $y(t)$.

Proposition. Let $y(t)$ be a solution of (7.20), then

$$\frac{d}{dt} E(y(t), m\dot{y}(t)) = 0$$

Consequently,

$$E(y, m\dot{y}) = \frac{m\dot{y}^2}{2} + F(y) = \text{const} = E(y_0, v_0) := E_0$$

and we can reduce the problem to an autonomous equation of order 1:

$$\dot{y} = \pm \sqrt{\frac{2E_0 - 2F(y)}{m}}.$$

Notice that the differential equation of (7.20) is equivalent to a Hamiltonian system of the form (7.14) (see section 7.3.5). In fact, if we set $p = m\dot{y}$, then

$$\dot{p} = -\frac{\partial E(y, p)}{\partial y} = -f(y), \quad \dot{y} = \frac{\partial E(y, p)}{\partial p} = \frac{p}{m}. \quad (7.21)$$

7.5 Systems of linear differential equations with constant coefficients

7.5.1 Homogeneous systems

Let $A \in M_{n,n}(\mathbb{R})$ (or even $A \in M_{n,n}(\mathbb{C})$). We consider the homogeneous system of differential equations

$$\mathbf{y}'(t) = A\mathbf{y}(t) \quad (7.22)$$

and its associated Cauchy problem:

$$\mathbf{y}'(t) = A\mathbf{y}(t), \quad \mathbf{y}(0) = \mathbf{y}_0. \quad (7.23)$$

The theorem on existence and uniqueness of local solutions ensures us the existence of a unique solution $\mathbf{y}(t)$ of (7.23). This solution can be extended to \mathbb{R} . In fact, $f(\mathbf{y}) = A\mathbf{y}$ is a Lipschitz function with $L = \|A\|_2$ on \mathbb{R}^n . We can choose $R_{a,b}$ such that $\alpha = \|A\|_2$ for any initial condition \mathbf{y}_0 . By iterations, we extend the solution to \mathbb{R} . Likewise for the solutions of (7.22).

Proposition - Superposition of the solutions. Let $\mathbf{y}_1(t), \mathbf{y}_2(t)$ be the functions of (7.22). Then, for any $\alpha, \beta \in \mathbb{R}$ the linear combination $\alpha\mathbf{y}_1(t) + \beta\mathbf{y}_2(t)$ is a solution of (7.22).

In analogy to the discussion in Chapter 7.3 the n solutions $\mathbf{y}_1(t), \dots, \mathbf{y}_n(t)$ are linearly independent if and only if the vectors $\mathbf{y}_1(t), \dots, \mathbf{y}_n(t)$ are linearly independent for any t . We recall that $\mathbf{y}_1(t), \dots, \mathbf{y}_n(t)$ are linearly independent if and only if

$$Y(t) = (\mathbf{y}_1(t), \dots, \mathbf{y}_n(t))$$

is invertible or if and only if "the Wronskian" $w(t) = \det Y(t)$ is non-zero. To find n linearly independent solutions, we search for $\mathbf{y}_1(t), \dots, \mathbf{y}_n(t)$ such that $\mathbf{y}_1(0) = \mathbf{e}_1, \dots, \mathbf{y}_n(0) = \mathbf{e}_n$, that is $Y(0) = Id_n$ (the identity matrix). From there follows:

Proposition: Every solution $\mathbf{y}(t)$ of (7.23) is of the form

$$\mathbf{y}(t) = \sum_{i=1}^n c_i \mathbf{y}_i(t)$$

Matricial differential equation. Therefore, we are trying to solve a differential equation for a matrix $n \times n$ $Y(t)$:

$$Y'(t) = AY(t), \quad Y(0) = Id_n = 1. \quad (7.24)$$

Its analogy to the equation with one function is perfect: in this case the solution was $y(t) = \exp(At)$ (see Chapter 7.2) In this case, for a matrix $A \in M_{n,n}(\mathbb{C})$ we define the exponential by the series

$$\exp(A) = \sum_{k=0}^{\infty} \frac{A^k}{k!} = 1 + A + \frac{A^2}{2} + \dots$$

This series converges absolutely in regards to the norm $\|A\|_2$. Using the results on absolutely convergent series we have the following result:

Theorem - solution of the matricial differential equation. The solution of (7.24) is given by

$$Y(t) = \exp(At) \quad (7.25)$$

and the solution to the Cauchy problem

$$\mathbf{y}'(t) = A\mathbf{y}(t), \quad \mathbf{y}(0) = \mathbf{y}_0 \quad (7.26)$$

is given by

$$\mathbf{y}(t) = \exp(At)\mathbf{y}_0 \quad (7.27)$$

In what follows we present some useful results for calculating $\exp(A)$.

Proposition - Properties of the exponential function. Let $A, B \in M_{n,n}(\mathbb{C})$. Then,

1.

$$\exp(A)\exp(B) = \exp(A+B) \quad \text{if } [A, B] := AB - BA = 0,$$

2.

$$\exp(B^{-1}AB) = B^{-1}\exp(A)B \quad \text{if } \det B \neq 0.$$

3.

$$\exp(A) = \lim_{k \rightarrow \infty} \left(1 + \frac{A}{k}\right)^k.$$

4.

$$\det(\exp(A)) = e^{\text{Tr}(A)}.$$

5. For a diagonal matrix:

$$\exp\left(\sum_{k=1}^n \lambda_k E_{kk}\right) = \sum_{k=1}^n e^{\lambda_k} E_{kk}.$$

Examples.

1.

$$A = \begin{pmatrix} 0 & 1 \\ 0 & 0 \end{pmatrix}, \quad \exp(At) = E_2 + At = \begin{pmatrix} 1 & t \\ 0 & 1 \end{pmatrix}$$

since $A^2 = A^3 = \dots = 0$.

2.

$$A = \begin{pmatrix} 0 & 1 \\ -1 & 0 \end{pmatrix}, \quad \exp(At) = \begin{pmatrix} \cos t & \sin t \\ -\sin t & \cos t \end{pmatrix}$$

since $A^{2n} = (-1)^n E_2$, $A^{2n+1} = (-1)^n A$.

3.

$$A = \begin{pmatrix} a & 0 \\ 0 & b \end{pmatrix}, \quad \exp(At) = \begin{pmatrix} e^{at} & 0 \\ 0 & e^{bt} \end{pmatrix}$$

The idea is to simplify the matrix by transforming it (for example to diagonalize it if possible) to calculate its exponential. This procedure is linked to determining the eigenvalues and eigenvectors.