

Renewable Energy

Prof. Sophia Haussener

MER Jan van Herle

Laboratory of Renewable Energy Sciences and Engineering

Renewable Energy

- Solar energy – lecture 1 – solar thermal:
 - Solar energy, solar potential
 - Conversion pathways
 - Solar thermal
- Solar energy – lecture 2 – photovoltaics (week 9)
- Solar energy – lecture 3 – solar fuels (week 11)

Learning outcomes of today's lecture

- Solar energy:
 - Theoretical potential, real potential, exploited potential
 - Characteristics of solar energy / solar irradiation
 - Possible conversion pathways
 - Solar energy for thermal applications (non-concentrated, low temperatures; and concentrated, high temperatures)

Renewable Energy

- Solar energy – lecture 1 – solar thermal:
 - Solar energy, solar potential
 - Conversion pathways
 - Solar thermal

Solar energy / Solar potential

- Potential of solar energy^{1,2}:

¹International Energy Agency, Statistics, 2012

²Lewis, MRS Bulletin, 2007

- Global primary energy demand 17 TW
- Of which 87% non-renewable (fossil, nuclear)
- Additional supply of renewable in the future 10-20 TW

	Potential (only land)	Based on:	Practical, Economical?
Solar	36000 TW	Annual average irradiation	500 TW
Wind	50 TW	Annual average wind speed	2 TW
Geothermal	9 TW	Average heat flux at earth surface	1 TW
Hydro	5 TW	Earth topology and water flow	2 TW
Biomass	108 TW	Annual average plant efficiency	7 TW

- Solar radiation is the indirect source for other renewables

Solar energy / Solar potential

- Solar irradiation:
 - Earth's ultimate recoverable oil resource delivered in 1.5 days
 - Global annual energy need delivered in 1 hour
 - 0.1% of earth surface covered (20% efficient) delivers global annual energy

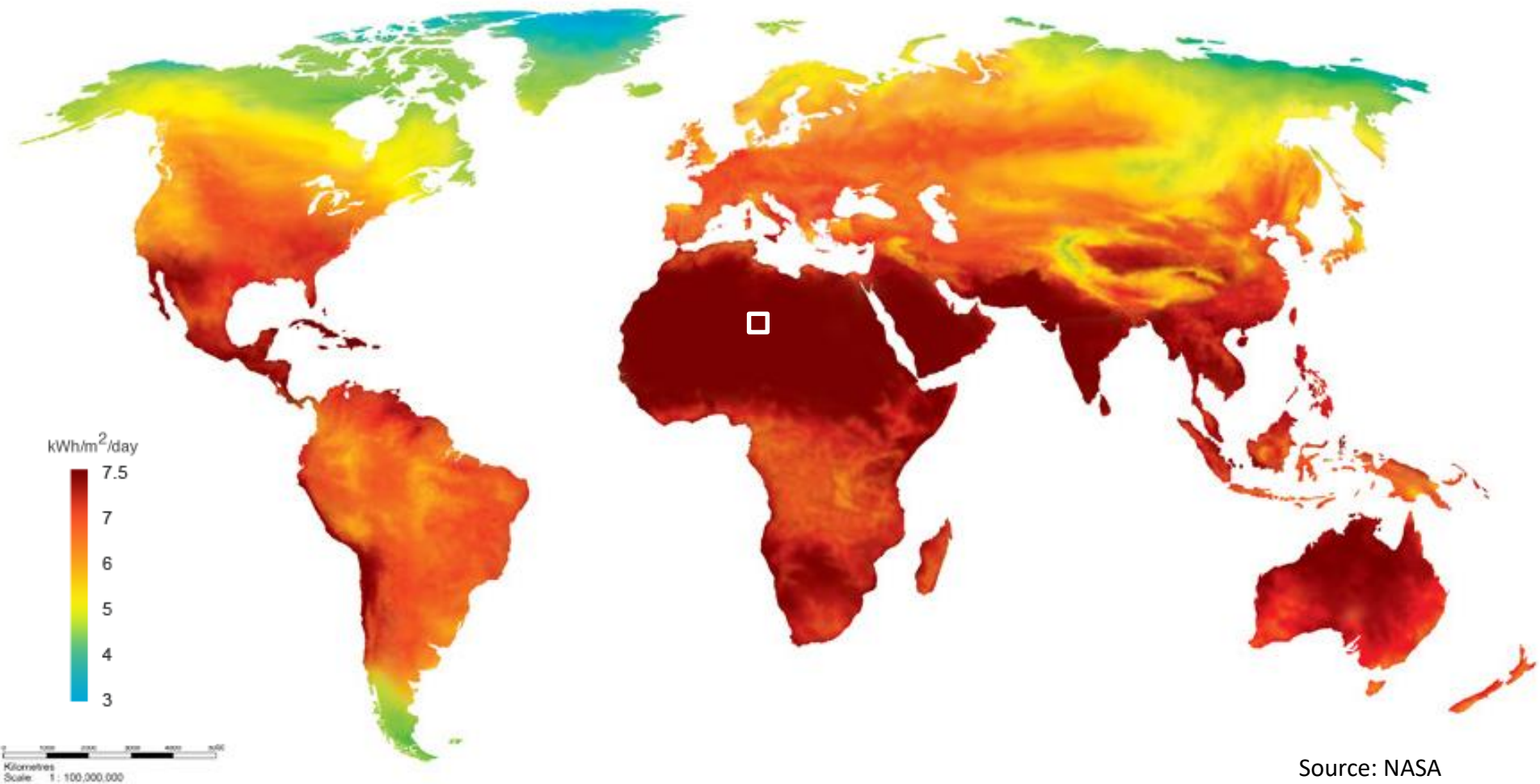

Source: NASA

Solar energy / Solar potential

- Solar energy characterization:
 - Due to fusion in the sun ($4^1\text{H} \rightarrow ^4\text{He} + \text{radiation/energy}$)

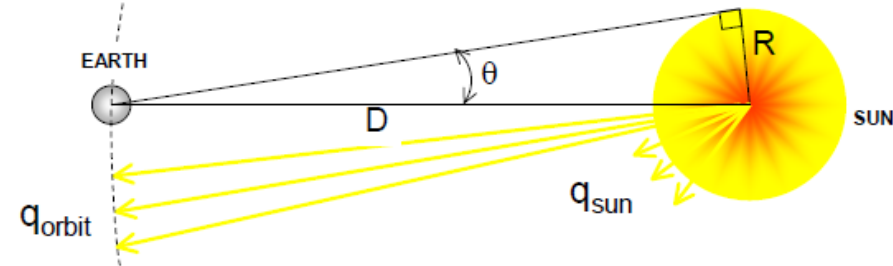

- Solar radiation at earth surface:

- $\theta = \sin^{-1}(R/D) = 4.65 \text{ mrad}$
- $q_{\text{sun}} \cdot 4\pi R^2 = q_{\text{orbit}} \cdot 4\pi D^2 \rightarrow q_{\text{orbit}} = 1353 \text{ W/m}^2$
- Achievable stagnation temperature:

$$q_{\text{use}} = \alpha q_{\text{orbit}} - \varepsilon \sigma (T^4 - T_{\text{amb}}^4) \quad q_{\text{use}} \rightarrow 0 \quad T_{\text{stag}} = 422 \text{ K}$$
- $q_{\text{sun}} = \sigma T^4 \rightarrow T = 5780 \text{ K}$

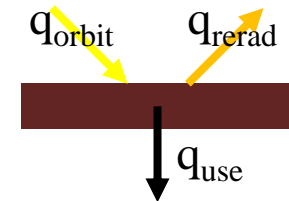

Solar energy / Solar potential

- Solar radiation at earth surface:

- Wavelength distribution

Close to black body at 5780 K:

$$E_{\lambda b}(\lambda, T) = \frac{2hc_0^2}{\lambda^5 (e^{hc_0/(k\lambda T)} - 1)}$$

$$I = \int_0^{\infty} I_{\lambda} d\lambda = 1353 \text{ W/m}^2 \approx 1000 \text{ W/m}^2$$

- Smaller than q_{orbit} (atmosphere)

- Partially diffuse/direct

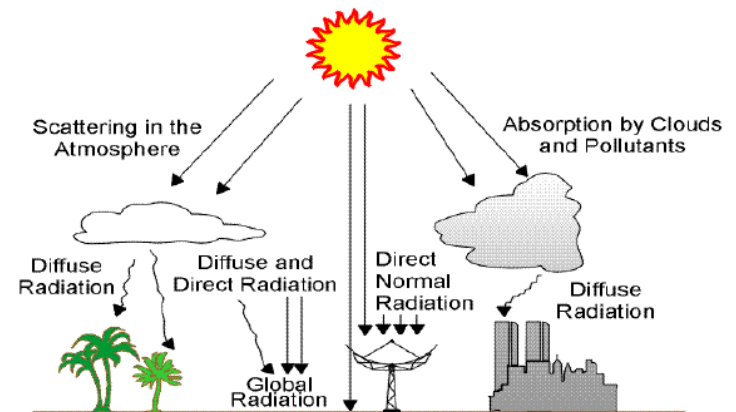
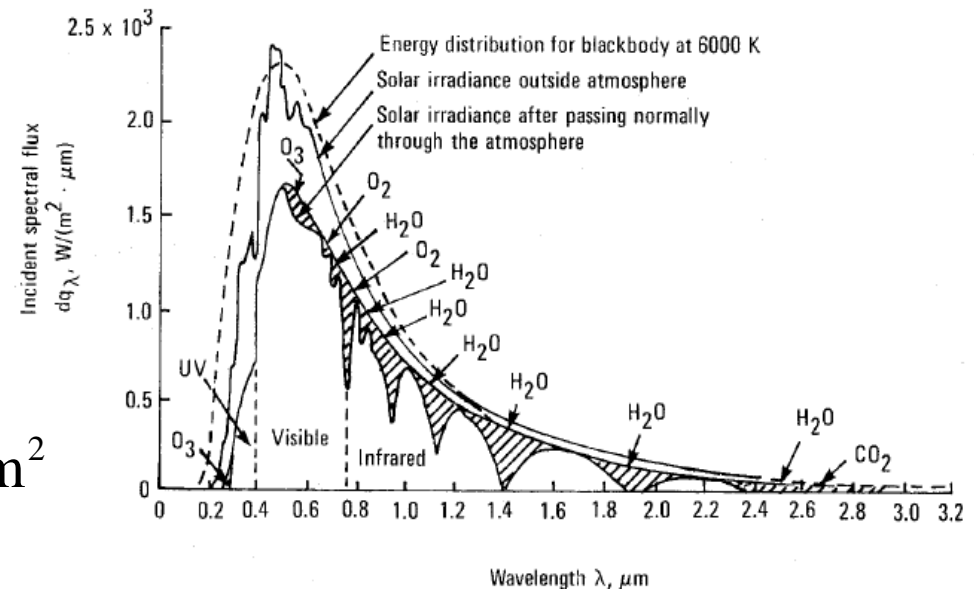

Solar energy / Solar potential

- Solar radiation at earth surface:
 - Effect of the atmosphere on power, spectrum and directionality
 - Power reduction due to absorption, scattering and reflection in the atmosphere
 - Spectral changes due wavelength-dependence of extinction
 - New diffuse component
 - Varies locally according to atmospheric conditions (e.g. such as water vapor, clouds and pollution)

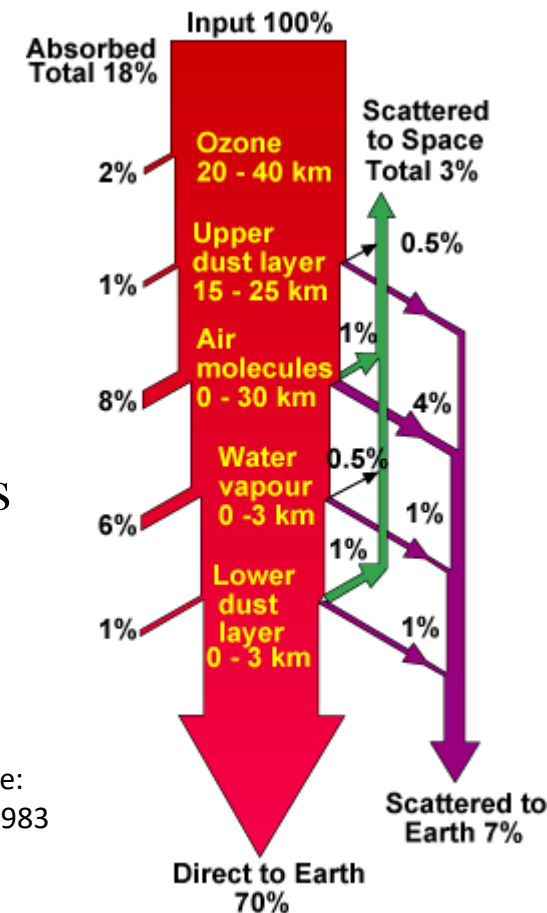

Hu and White:
Solar Cells, 1983

Solar energy / Solar potential

- Definitions:

- Air mass (AM):

AM is the path length which light travels through the atmosphere normalized to the shortest possible path length (sun is directly overhead).

AM quantifies the reduction in the power of light as it passes through the atmosphere and is absorbed by air and dust:

$$AM = \frac{1}{\cos \theta} = \frac{Y}{X}$$

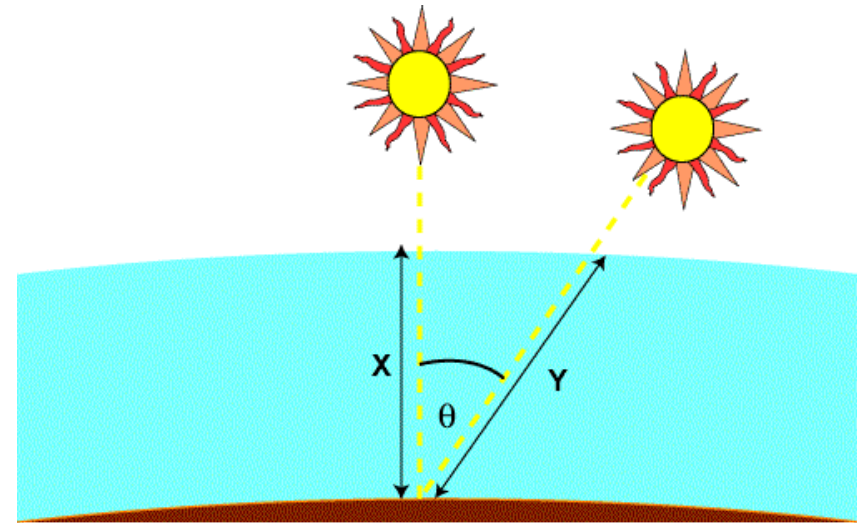

- AM0: solar spectrum outside of the atmosphere with 1353 W/m²
- AMx defines both the spectrum and the power density
- AM1.5D = only direct radiation, normalized at 900 W/m²
- AM1.5G = including diffuse radiation, normalized at 1000 W/m²

Solar energy / Solar potential

- Solar radiation at earth surface:

- Wavelength distribution

Close to black body at 5780 K:

$$E_{\lambda b}(\lambda, T) = \frac{2hc_0^2}{\lambda^5 (e^{hc_0/(k\lambda T)} - 1)}$$

$$E_b = \int_0^{\infty} E_{\lambda b} d\lambda = \sigma T^4 \quad \sigma = \frac{2hc_0^2 \pi^5 k^4}{15h^4 c_0^4}$$

$$\frac{\partial E_{\lambda b}(\lambda, T) / T^5}{\partial(\lambda T)} = 0 \rightarrow \lambda_{\max} T = 2897.8 \mu\text{mK}$$

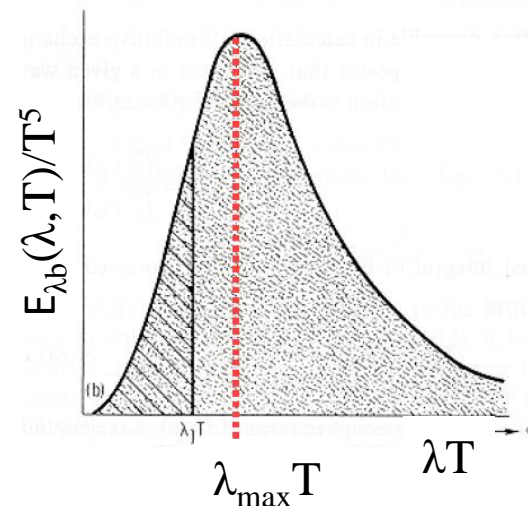
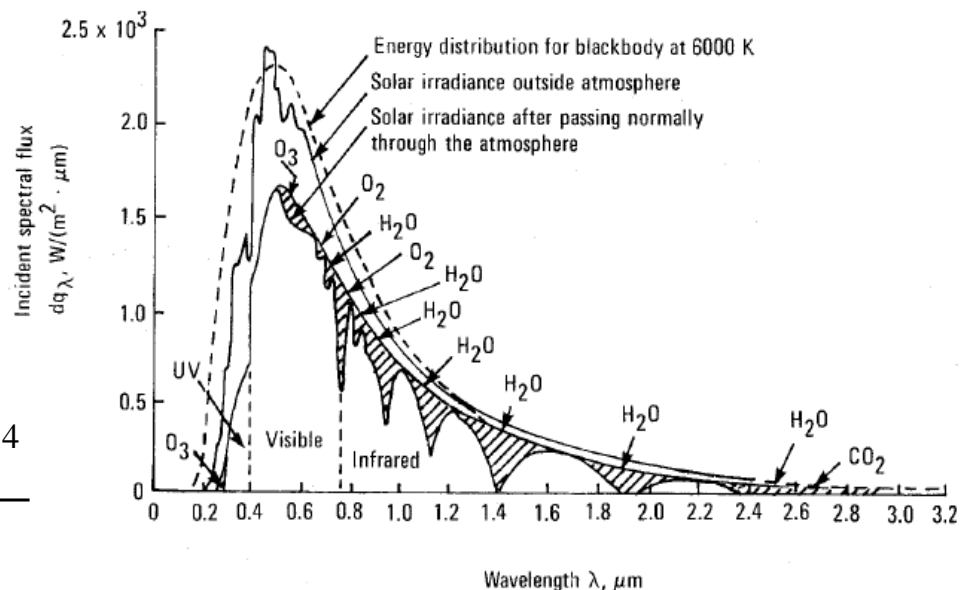

Solar energy / Solar potential

- Solar radiation at earth surface:
 - Wavelength distribution

$$F_{\lambda_1-\lambda_2} = \frac{\int_{\lambda_1}^{\lambda_2} E_{\lambda b} d\lambda}{\int_0^{\infty} E_{\lambda b} d\lambda} = \frac{\int_{\lambda_1}^{\lambda_2} E_{\lambda b} d\lambda}{\sigma T^4}$$

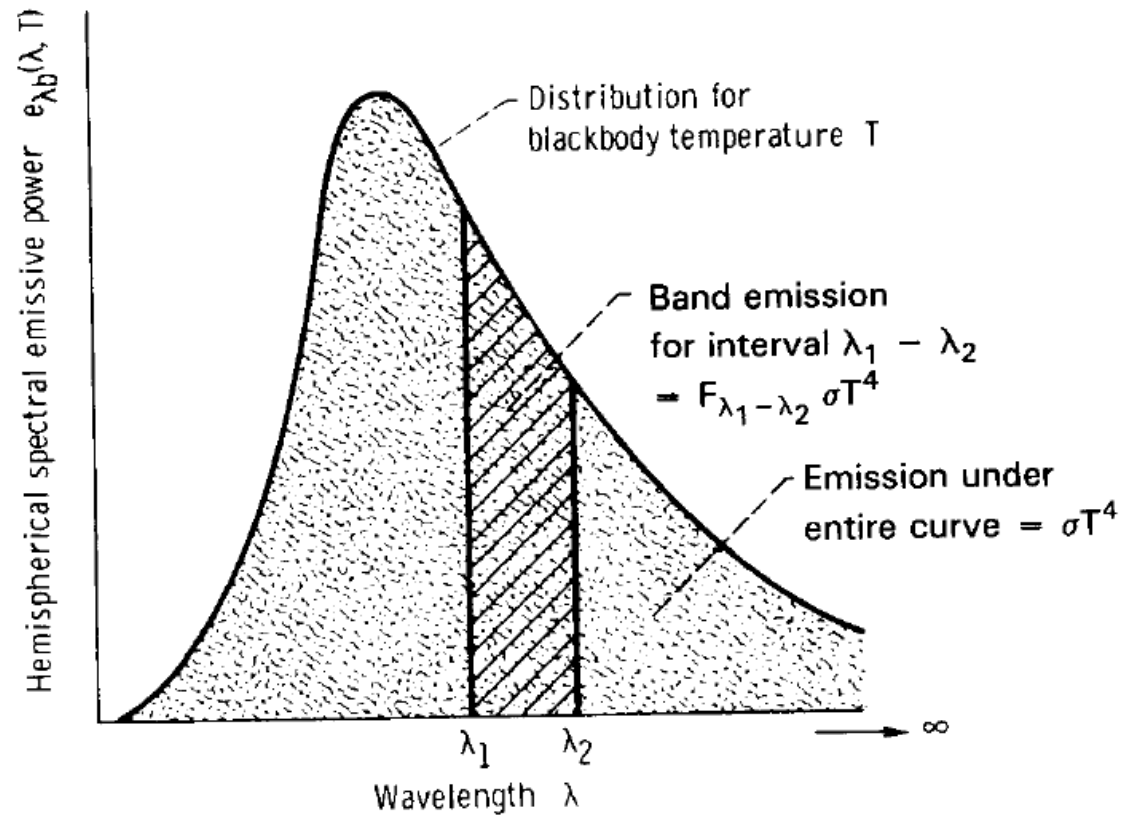

$F_{\lambda_1-\lambda_2}$

λT [10^{-6} m K]	$F_{0-\lambda T}$	λT [10^{-6} m K]	$F_{0-\lambda T}$	λT [10^{-6} m K]	$F_{0-\lambda T}$	λT [10^{-6} m K]	$F_{0-\lambda T}$	λT [10^{-6} m K]	$F_{0-\lambda T}$	λT [10^{-6} m K]	$F_{0-\lambda T}$
500	1.299E-09	3150	0.307	5800	0.720	8450	0.873	11100	0.933	13750	0.961
550	1.349E-08	3200	0.318	5850	0.725	8500	0.875	11150	0.934	13800	0.961
600	9.294E-08	3250	0.329	5900	0.729	8550	0.876	11200	0.935	13850	0.962
650	4.674E-07	3300	0.340	5950	0.734	8600	0.878	11250	0.936	13900	0.962
700	1.839E-06	3350	0.351	6000	0.738	8650	0.879	11300	0.936	13950	0.963
750	5.949E-06	3400	0.362	6050	0.742	8700	0.881	11350	0.937	14000	0.963
800	1.644E-05	3450	0.372	6100	0.746	8750	0.883	11400	0.938	14050	0.963
850	3.990E-05	3500	0.383	6150	0.750	8800	0.884	11450	0.938	14100	0.964
900	8.703E-05	3550	0.393	6200	0.754	8850	0.886	11500	0.939	14150	0.964
950	1.735E-04	3600	0.404	6250	0.758	8900	0.887	11550	0.940	14200	0.964
1000	3.208E-04	3650	0.414	6300	0.762	8950	0.889	11600	0.940	14250	0.965
1050	5.559E-04	3700	0.424	6350	0.766	9000	0.890	11650	0.941	14300	0.965
1100	9.113E-04	3750	0.434	6400	0.769	9050	0.891	11700	0.941	14350	0.965
1150	0.001	3800	0.443	6450	0.773	9100	0.893	11750	0.942	14400	0.965
1200	0.002	3850	0.453	6500	0.776	9150	0.894	11800	0.943	14450	0.966
1250	0.003	3900	0.462	6550	0.780	9200	0.895	11850	0.943	14500	0.966
1300	0.004	3950	0.472	6600	0.783	9250	0.897	11900	0.944	14550	0.966
1350	0.006	4000	0.481	6650	0.786	9300	0.898	11950	0.944	14600	0.967
1400	0.008	4050	0.490	6700	0.790	9350	0.899	12000	0.945	14650	0.967
1450	0.010	4100	0.499	6750	0.793	9400	0.901	12050	0.946	14700	0.967
1500	0.013	4150	0.507	6800	0.796	9450	0.902	12100	0.946	14750	0.968
1550	0.016	4200	0.516	6850	0.799	9500	0.903	12150	0.947	14800	0.968
1600	0.020	4250	0.524	6900	0.802	9550	0.904	12200	0.947	14850	0.968
1650	0.024	4300	0.533	6950	0.805	9600	0.905	12250	0.948	14900	0.968
1700	0.029	4350	0.541	7000	0.808	9650	0.907	12300	0.948	14950	0.969
1750	0.034	4400	0.549	7050	0.811	9700	0.908	12350	0.949	15000	0.969
1800	0.039	4450	0.557	7100	0.814	9750	0.909	12400	0.949	15050	0.969
1850	0.045	4500	0.564	7150	0.816	9800	0.910	12450	0.950	15100	0.969
1900	0.052	4550	0.572	7200	0.819	9850	0.911	12500	0.950	15150	0.970
1950	0.059	4600	0.579	7250	0.822	9900	0.912	12550	0.951	15200	0.970
2000	0.067	4650	0.587	7300	0.824	9950	0.913	12600	0.951	15250	0.970
2050	0.075	4700	0.594	7350	0.827	10000	0.914	12650	0.952	15300	0.971
2100	0.083	4750	0.601	7400	0.829	10050	0.915	12700	0.952	15350	0.971

$F_{\lambda_1-\lambda_2}$

1450	0.010	4100	0.499	6750	0.793	9400	0.901	12050	0.946	14700	0.967
1500	0.013	4150	0.507	6800	0.796	9450	0.902	12100	0.946	14750	0.968
1550	0.016	4200	0.516	6850	0.799	9500	0.903	12150	0.947	14800	0.968
1600	0.020	4250	0.524	6900	0.802	9550	0.904	12200	0.947	14850	0.968
1650	0.024	4300	0.533	6950	0.805	9600	0.905	12250	0.948	14900	0.968
1700	0.029	4350	0.541	7000	0.808	9650	0.907	12300	0.948	14950	0.969
1750	0.034	4400	0.549	7050	0.811	9700	0.908	12350	0.949	15000	0.969
1800	0.039	4450	0.557	7100	0.814	9750	0.909	12400	0.949	15050	0.969
1850	0.045	4500	0.564	7150	0.816	9800	0.910	12450	0.950	15100	0.969
1900	0.052	4550	0.572	7200	0.819	9850	0.911	12500	0.950	15150	0.970
1950	0.059	4600	0.579	7250	0.822	9900	0.912	12550	0.951	15200	0.970
2000	0.067	4650	0.587	7300	0.824	9950	0.913	12600	0.951	15250	0.970
2050	0.075	4700	0.594	7350	0.827	10000	0.914	12650	0.952	15300	0.971
2100	0.083	4750	0.601	7400	0.829	10050	0.915	12700	0.952	15350	0.971
2150	0.092	4800	0.608	7450	0.832	10100	0.916	12750	0.953	15400	0.971
2200	0.101	4850	0.614	7500	0.834	10150	0.917	12800	0.953	15450	0.971
2250	0.110	4900	0.621	7550	0.837	10200	0.918	12850	0.954	15500	0.971
2300	0.120	4950	0.627	7600	0.839	10250	0.919	12900	0.954	15550	0.972
2350	0.130	5000	0.634	7650	0.841	10300	0.920	12950	0.955	15600	0.972
2400	0.140	5050	0.640	7700	0.844	10350	0.921	13000	0.955	15650	0.972
2450	0.151	5100	0.646	7750	0.846	10400	0.922	13050	0.956	15700	0.972
2500	0.161	5150	0.652	7800	0.848	10450	0.923	13100	0.956	15750	0.973
2550	0.172	5200	0.658	7850	0.850	10500	0.924	13150	0.956	15800	0.973
2600	0.183	5250	0.664	7900	0.852	10550	0.925	13200	0.957	15850	0.973
2650	0.194	5300	0.669	7950	0.854	10600	0.925	13250	0.957	15900	0.973
2700	0.205	5350	0.675	8000	0.856	10650	0.926	13300	0.958	15950	0.974
2750	0.217	5400	0.680	8050	0.858	10700	0.927	13350	0.958	16000	0.974
2800	0.228	5450	0.686	8100	0.860	10750	0.928	13400	0.958	16050	0.974
2850	0.239	5500	0.691	8150	0.862	10800	0.929	13450	0.959	16100	0.974
2900	0.251	5550	0.696	8200	0.864	10850	0.930	13500	0.959	16150	0.974
2950	0.262	5600	0.701	8250	0.866	10900	0.930	13550	0.960	16200	0.975
3000	0.273	5650	0.706	8300	0.868	10950	0.931	13600	0.960	16250	0.975
3050	0.285	5700	0.711	8350	0.869	11000	0.932	13650	0.960	16300	0.975
3100	0.296	5750	0.715	8400	0.871	11050	0.933	13700	0.961	16350	0.975

Solar energy / Solar potential

- Spatial and temporal distribution

- Local position:

- ϕ : latitude angle

- δ_s : solar declination, $\delta_s = 23.45^\circ \sin\left(\frac{360(284+n)}{365}\right)$, $n = 1 \dots 365$

- ω : hour angle, $\omega = 15(\text{ST}-12)$

- ST: solar time

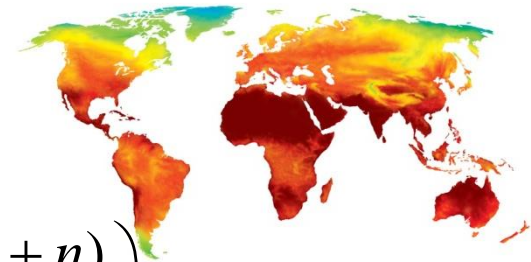

- Sun position:

- ψ : solar azimuth angle,

$$\sin(\psi) = \frac{\cos(\delta_s) \sin(\omega)}{\cos(\alpha)}$$

- α : solar altitude angle,

$$\sin(\alpha) = \sin(\phi) \sin(\delta_s) + \cos(\phi) \cos(\delta_s) \cos(\omega)$$

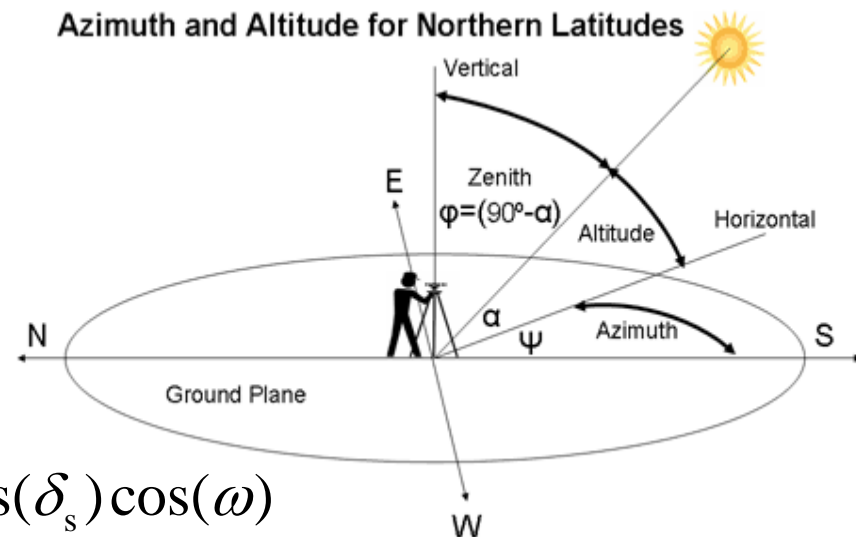

Solar energy / Solar potential

- Spatial and temporal distribution
 - Local position:
 - ϕ : latitude angle: angle between a line from the center of the earth to the site of interest and the equatorial plane. Values north of equator are positive and those south are negative, $[-90^\circ, 90^\circ]$
 - δ_s : solar declination: angular position of the sun at solar noon with respect to the plane of the equator. Declinations are positive in northern hemisphere and negative in southern hemisphere, $[-23.45^\circ, 23.45^\circ]$
 - ω : hour angle: angular displacement of the sun east or west of the local meridian, based on the nominal time of 24 hours for the sun to travel 360° , or 15° per hour. When the sun is due south for northern hemisphere (due north for southern hemisphere), the hour angle is 0, morning values are negative, afternoon values are positive

Example - Lausanne

- Latitude of Lausanne is 46.52 and longitude of Lausanne is 6.63

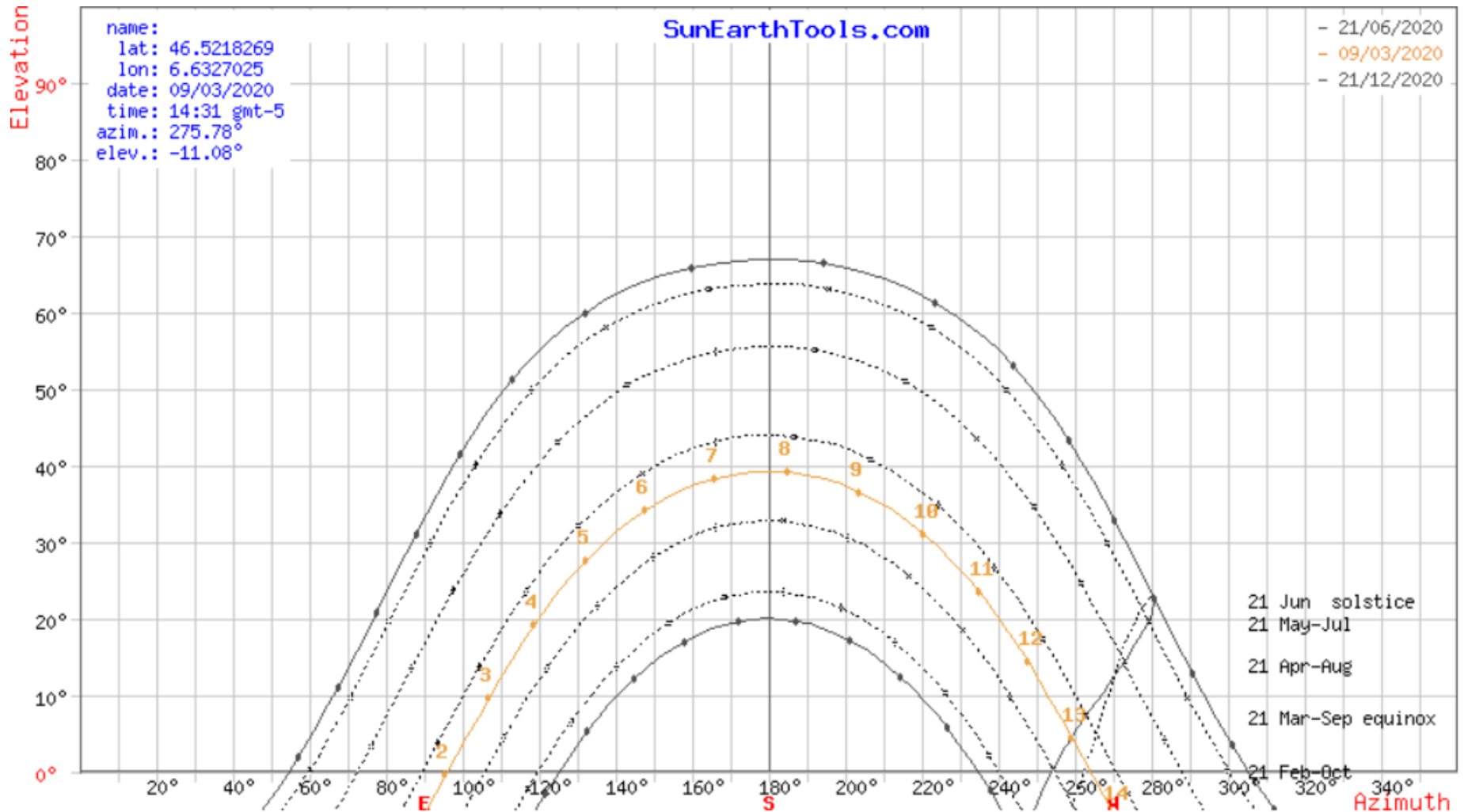

http://www.sunearthtools.com/dp/tools/pos_sun.php?lang=de

Solar energy / Solar potential

- Solar radiation, variations:

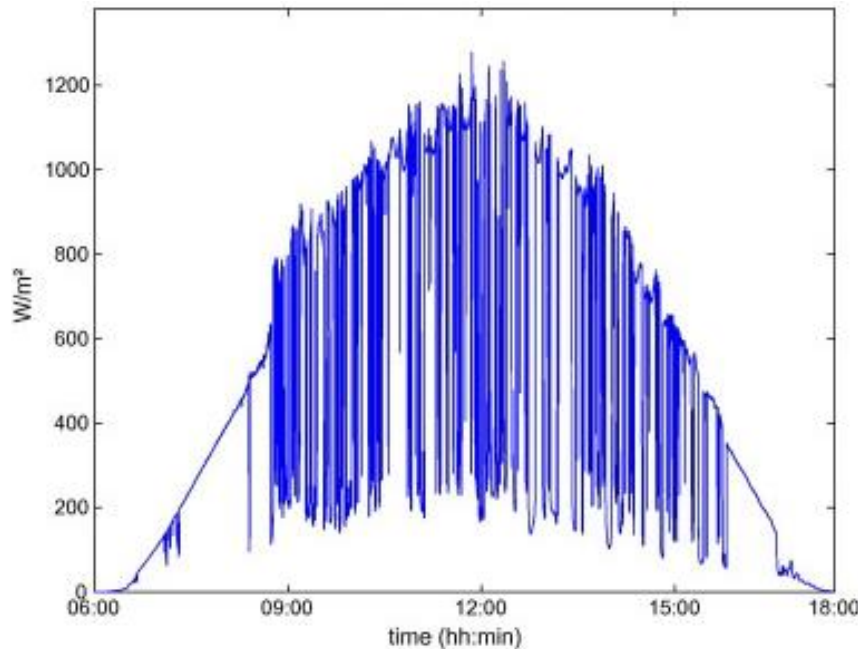

Measured solar irradiation in Guadalupe, one day in 2005-2006, Soubdhan et al. 2009

- Solar energy: dilute, unequally distributed, intermittent

Renewable Energy

- Solar energy – lecture 1 – solar thermal:
 - Solar energy, solar potential
 - Conversion pathways
 - Solar thermal

Conversion pathways

- Solar energy conversion
 - Solar to electric
 - Solar to thermal
 - Solar to fuel/material

Conversion pathways

- Solar energy conversion

- Solar to electric:
photovoltaic

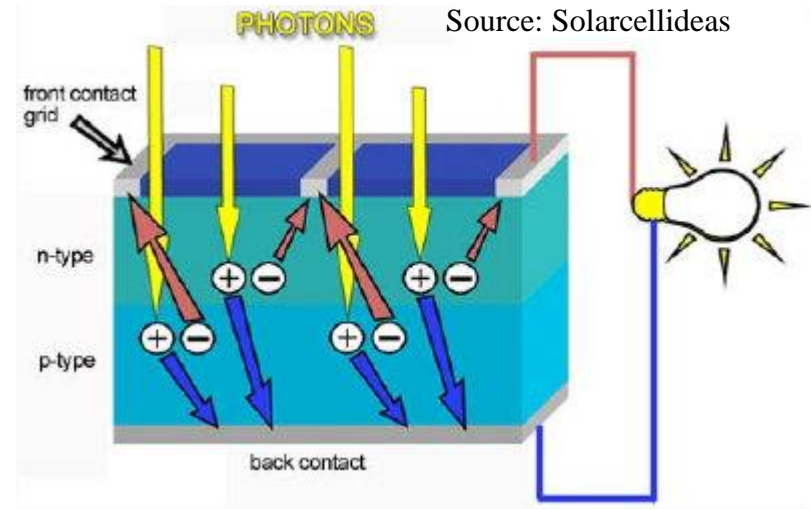

- Solar to electric:
solar thermal plus power cycle

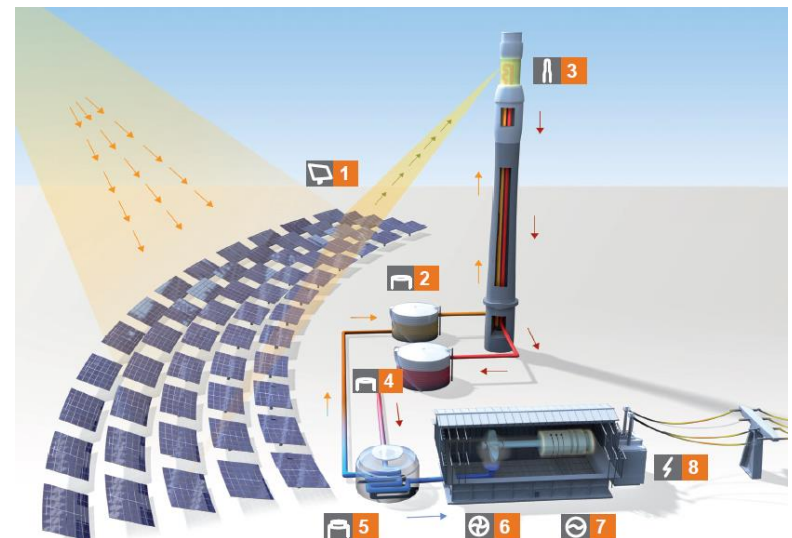

Conversion pathways

- Solar energy conversion
 - Solar to thermal:
low temperature, unconcentrated

 - Solar to thermal:
high temperature, concentrated



Conversion pathways

- Solar energy conversion
 - Solar to fuel/material photoelectrochemical

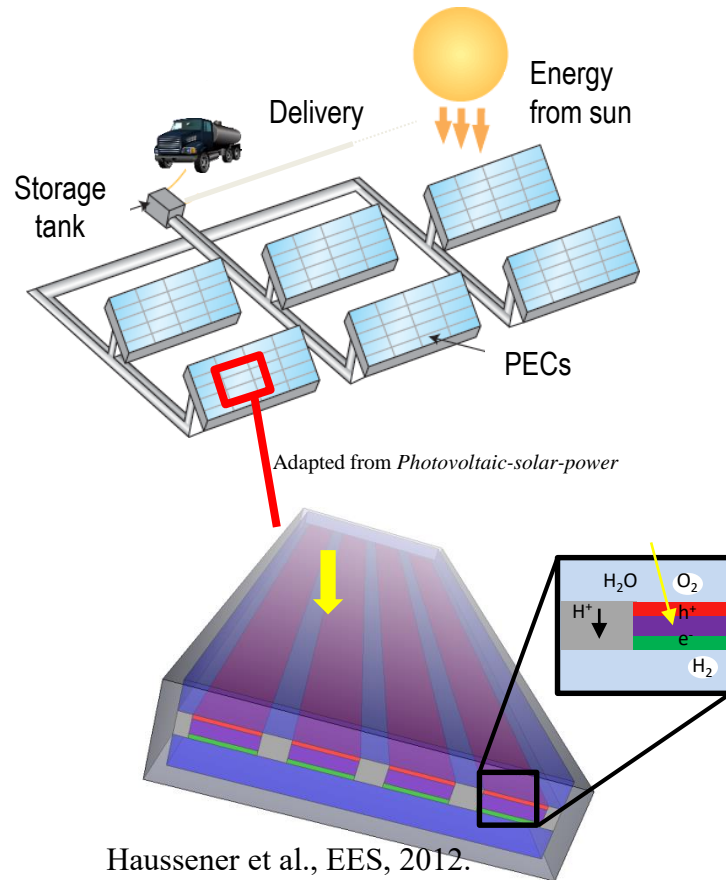

solar thermochemical

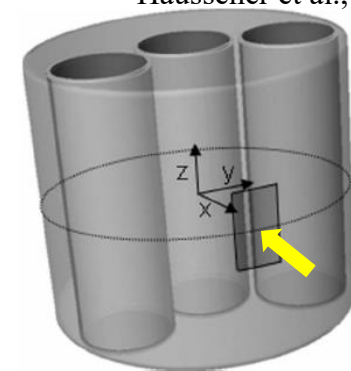
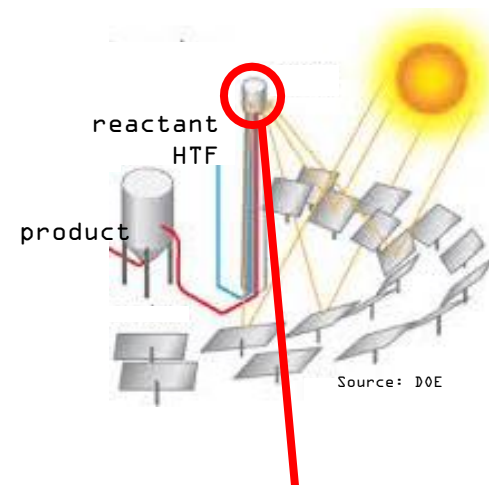

Renewable Energy

- Solar energy – lecture 1 – solar thermal:
 - Solar energy, solar potential
 - Conversion pathways
 - Solar thermal

Conversion pathways: Solar to thermal

- Solar to thermal:
 - non or low-concentrating
 - concentrating

Conversion pathways: Solar to thermal

- Solar to thermal: non or low-concentrating
 - A solar collector is a heat exchanger that converts solar energy into heat. It absorbs the solar radiation and transfers the thermal energy to a working fluid.
 - Common working fluids: water, oil, air
 - Air collectors suitable for space heating and convective dry applications.
 - Liquid collectors suitable for domestic and industrial hot water applications.
 - Collector types:
 - Flat-plate collectors
 - Evacuated tubular collectors
 - 2D compound parabolic concentrators

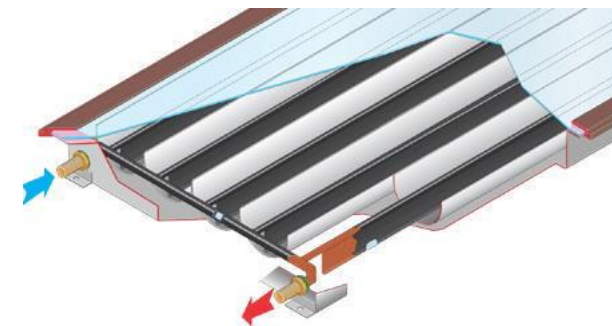
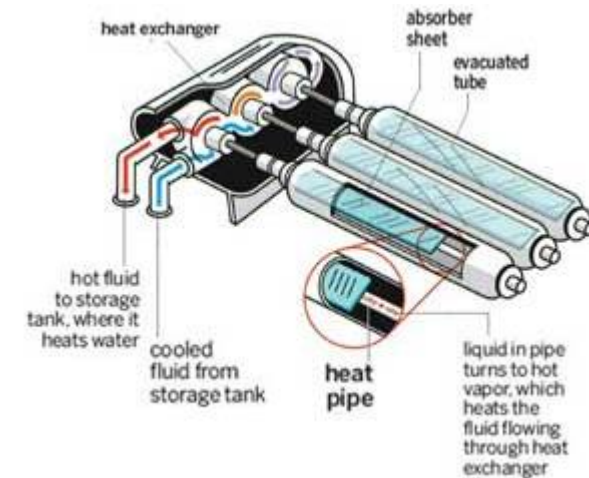
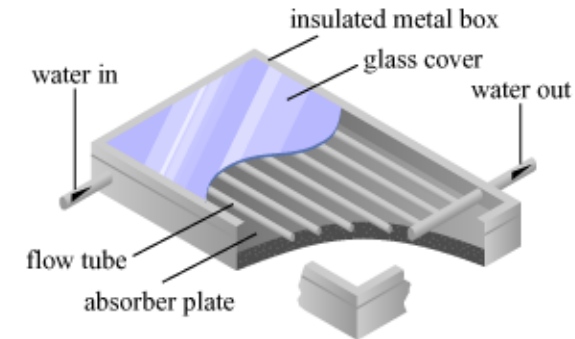

Conversion pathways: Solar to thermal

- Solar to thermal: non or low-concentrating
 - Flat-plate solar collectors
 - Diffuse and direct radiation
 - Losses:
 - Reflection at window
 - Convection at window
 - Convection and conduction through insulation
 - Emission from absorber through window
- Temperature range: 30-80°C
- Concentration: 1

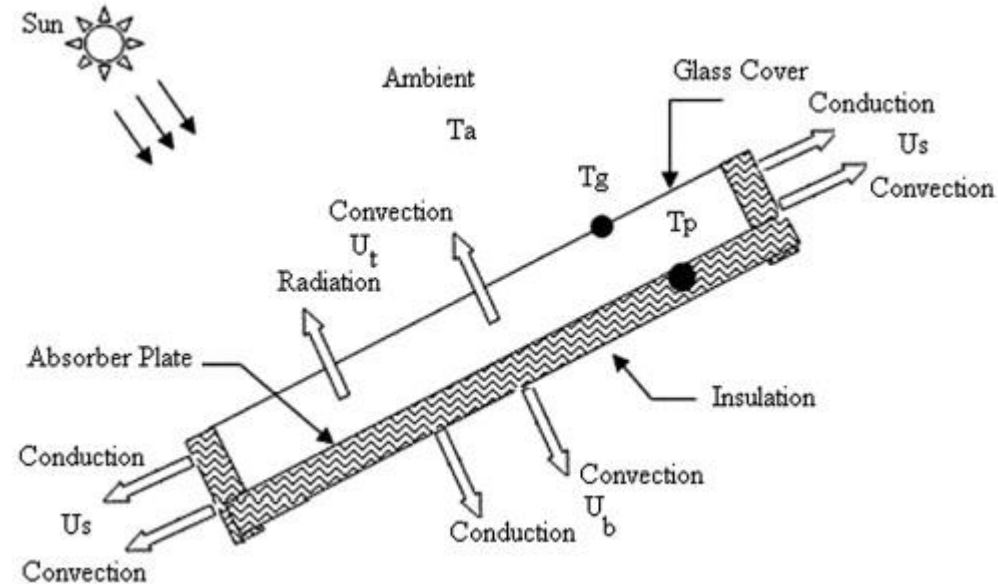

Conversion pathways: Solar to thermal

- Solar to thermal: non or low-concentrating
 - Flat-plate solar collectors: typical absorber configurations
 - Liquid working fluid

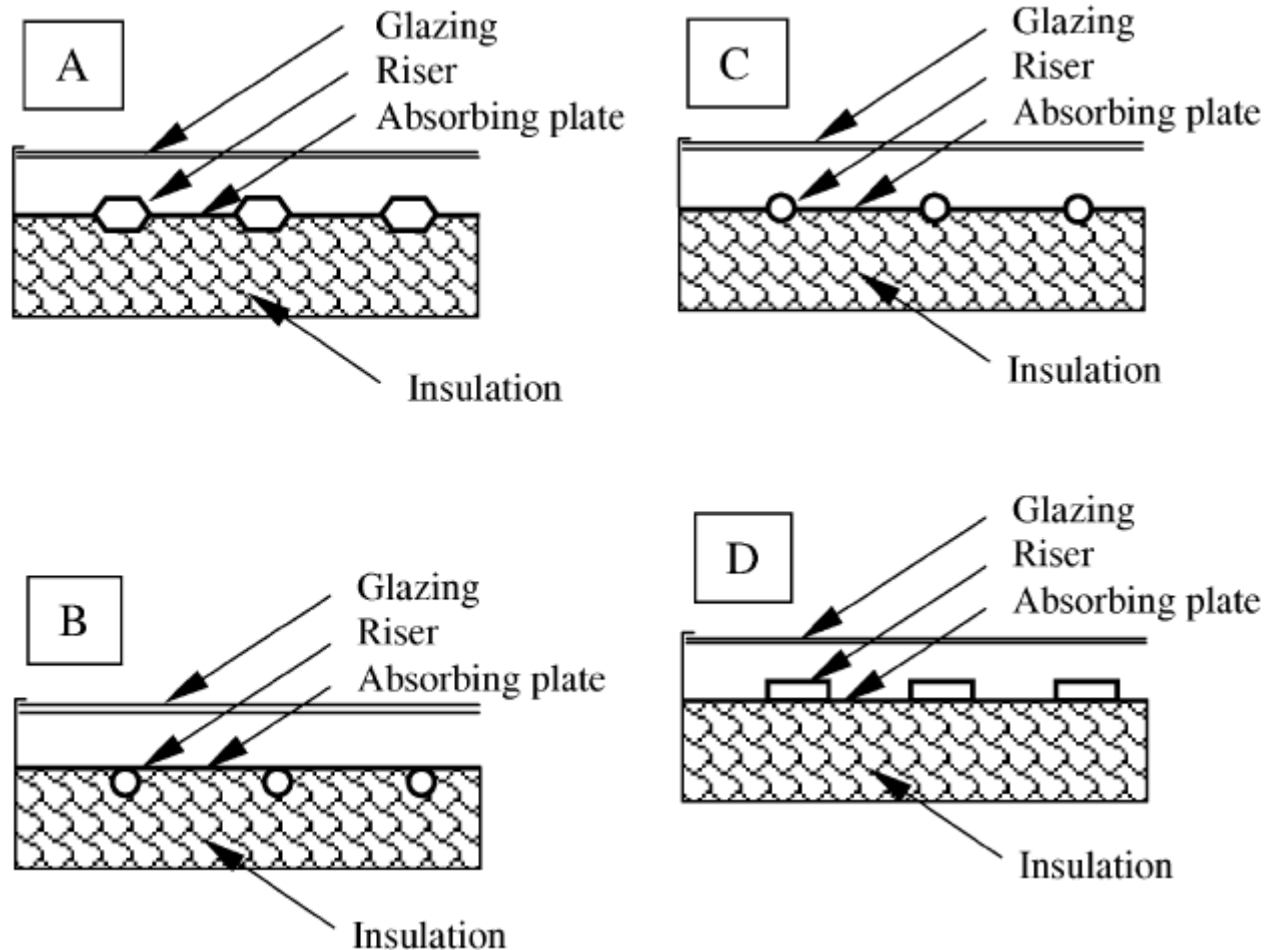

Kalogirou, 2004

Conversion pathways: Solar to thermal

- Solar to thermal: non or low-concentrating
 - Flat-plate solar collectors: typical absorber configurations
 - Air as working fluid
 - Lower specific heat capacity (larger volume flow rates, larger pumping power)
 - Lower heat transfer coefficients between air and absorber
 - Open loop or closed loop

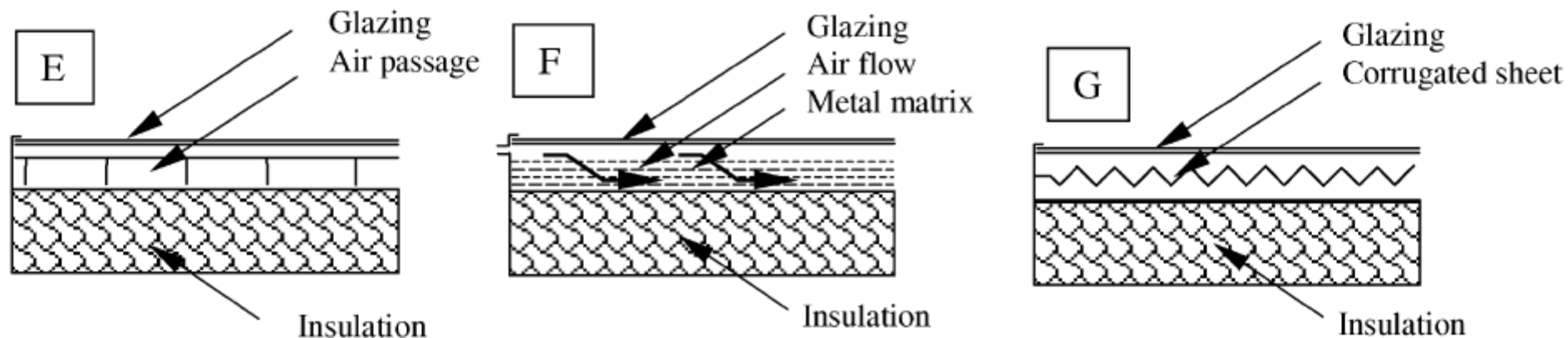

Kalogirou, 2004

Conversion pathways: Solar to thermal

- Solar to thermal: non or low-concentrating
 - Flat-plate solar collectors: Efficiency

- Useful energy:

$$q_c = A_c F' \left(q_{\text{sol,in}} \eta_{\text{opt}} - U_L (T_{\text{cm}} - T_a) \right) = mc_p (T_{\text{co}} - T_{\text{ci}})$$

- F' : Flat-plate efficiency (depends on absorber design), η_{opt} : optical efficiency (transmission through window and absorption on plate)
- Using inlet collector temperature, Hottel-Whillier-Bliss equation:

$$q_c = A_c F_R \left(q_{\text{sol,in}} \eta_{\text{opt}} - U_L (T_{\text{ci}} - T_a) \right)$$

with

$$\frac{F_R}{F'} = \frac{mc_p}{A_c F' U_L} \left[1 - \exp \left(- \frac{A_c F' U_L}{mc_p} \right) \right]$$

- F_R : heat removal factor

- Efficiency:

$$\eta = \frac{q_c}{q_{\text{sol,in}} A_c} = \frac{mc_p (T_{\text{co}} - T_{\text{ci}})}{q_{\text{sol,in}} A_c} = F_R \eta_{\text{opt}} - F_R U_L \left(\frac{T_{\text{ci}} - T_a}{q_{\text{sol,in}}} \right)$$

Conversion pathways: Solar to the

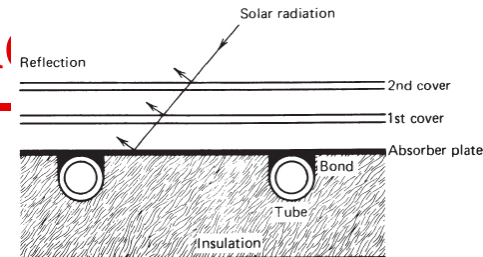

- Top heat loss coefficient, U_T ($U_L = U_T + U_B + U_E$):

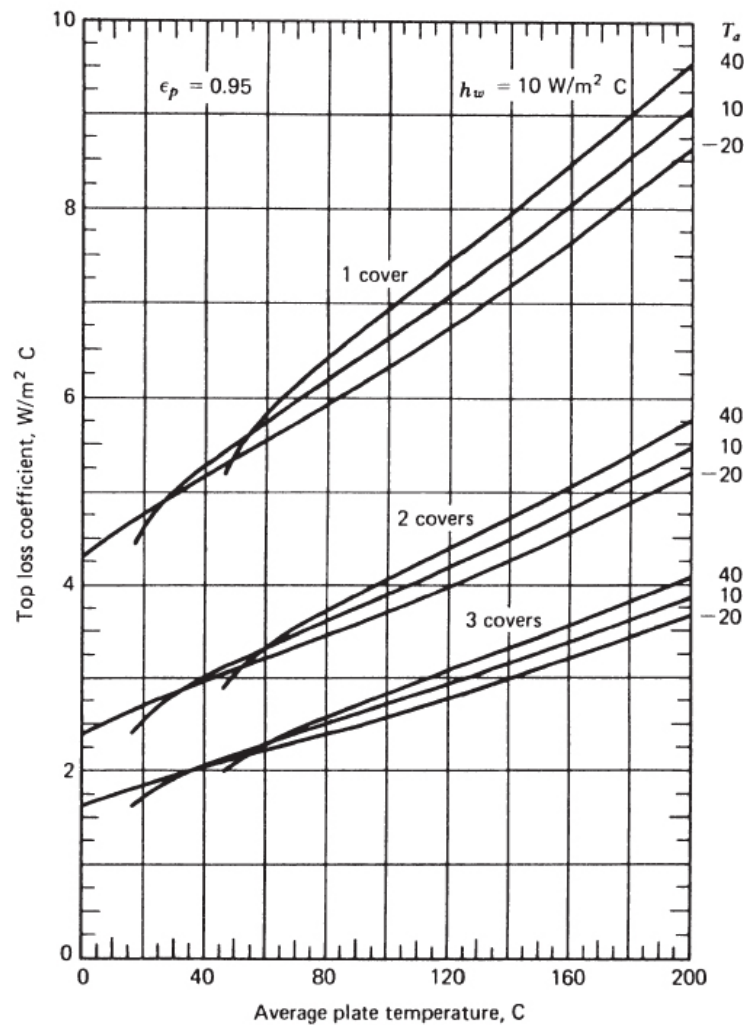
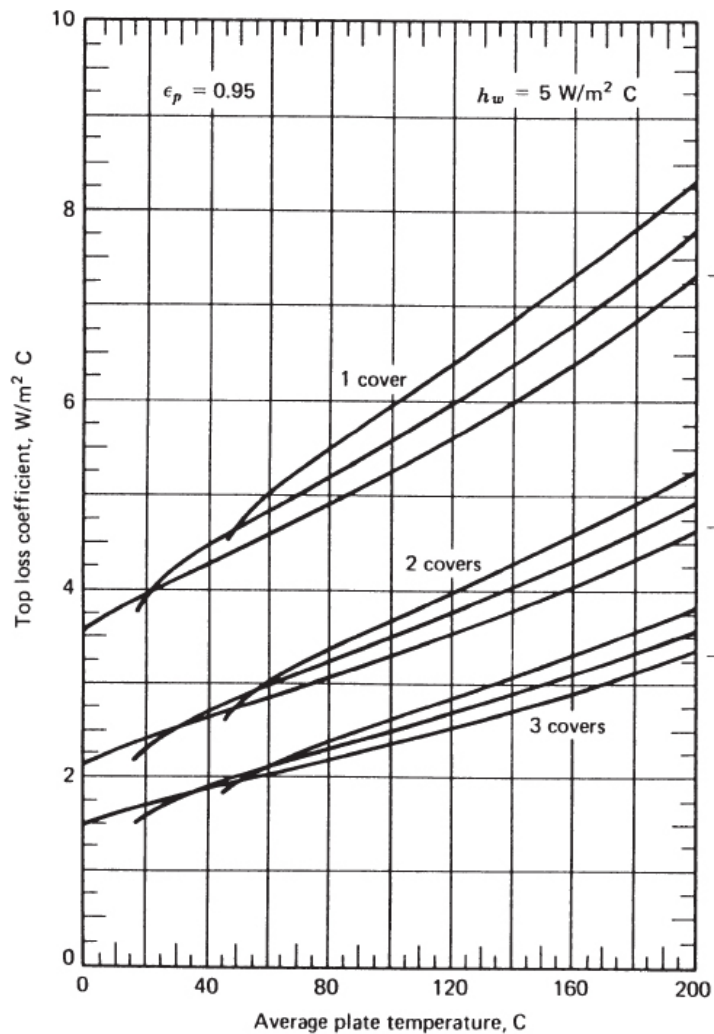

Conversion pathways: Solar to thermal

- Collector efficiency factor, F' :

Heat removal factor, F_R :

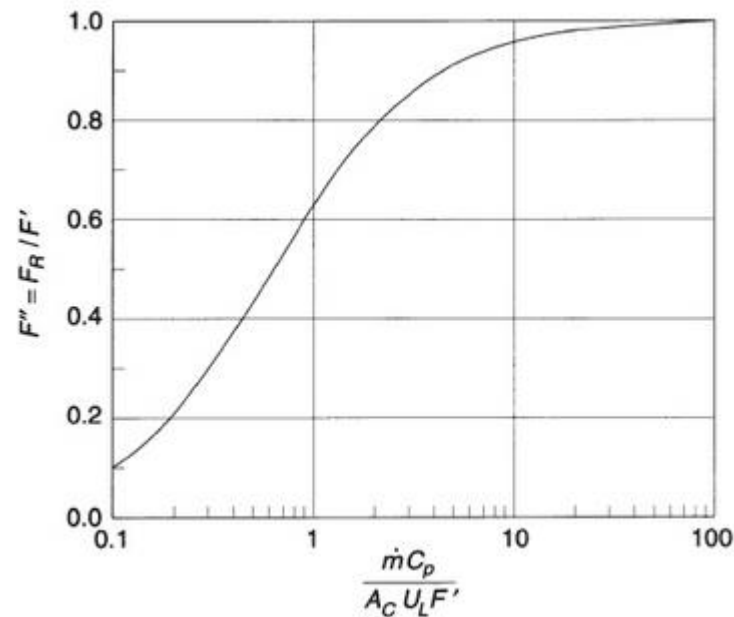
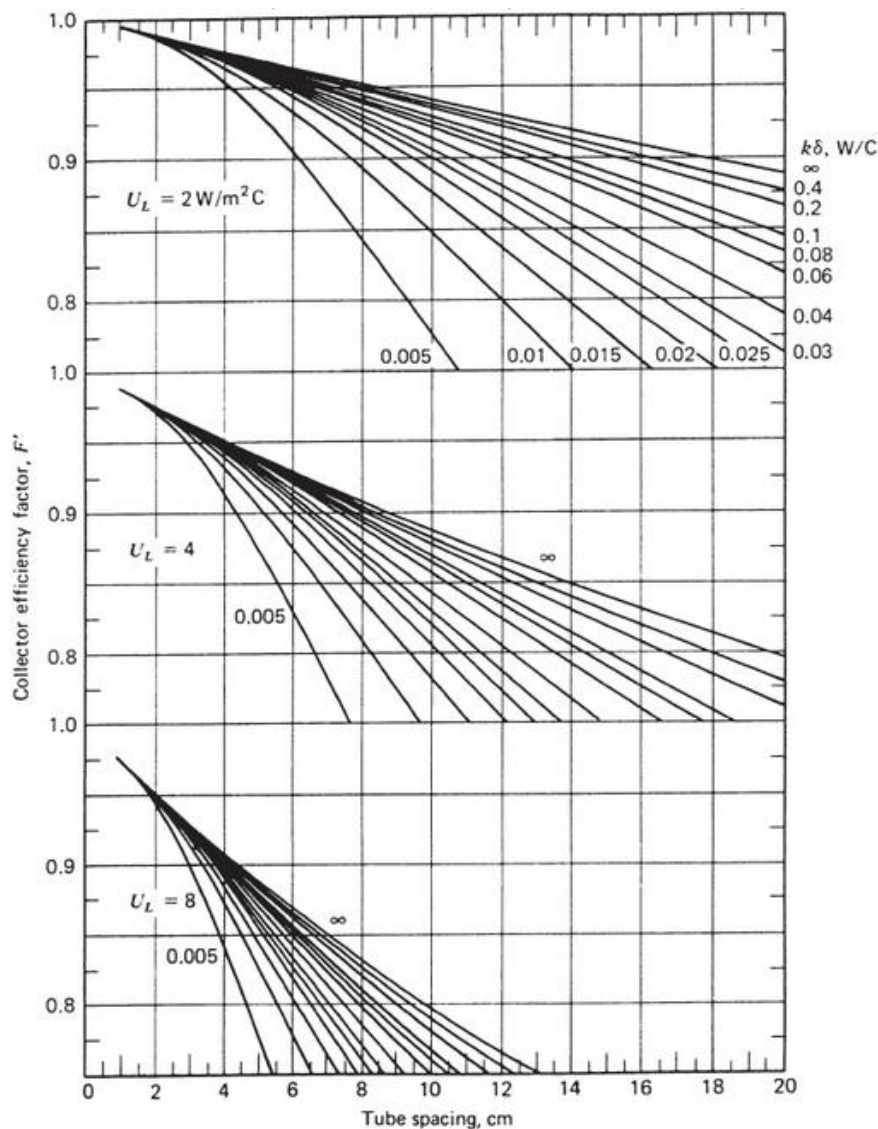

Conversion pathways: Solar to thermal

- Solar to thermal: non or low-concentrating
 - Flat-plate solar collectors: Other characteristics
 - Collector time constant:
$$\frac{T_{\text{co},t} - T_{\text{ci}}}{T_{\text{co,ini}} - T_{\text{ci}}} = \frac{1}{e} = 0.368$$
 - Stagnation temperature:
$$q_c = 0$$
$$T_{\text{ci}} = T_a + \frac{q_{\text{sol,in}} \eta_{\text{opt}}}{U_L}$$
 - Pressure drop for active systems: keep parasitic energy consumption low (electricity for pumps and blowers)
 - Improving performance:
 - selective window and absorber coating
 - two glass cover
 - improved absorber and heat transfer fluid tube connections (e.g. high quality welding)

Conversion pathways: Solar to thermal

- Flat-plate solar collectors:



Kaidun solar energy



12m² air collectors for Bettelwürfhütte, Austria (source: Grammer Solar)



Glazed flat plate collectors integrated in building, Architect Philippon

Conversion pathways: Solar to thermal

- Solar to thermal: non or low-concentrating
 - Evacuated tubular collector
 - Diffuse and direct radiation
 - Advantage:
 - Convection losses reduced
 - More flexible to weather variations as condensation and moisture is avoided
 - Inherent freezing/overheating protection
 - Temperature range: 50-200°C
 - Concentration: 1
 - Use liquid-vapor phase change heat transfer fluids in evacuated tubes

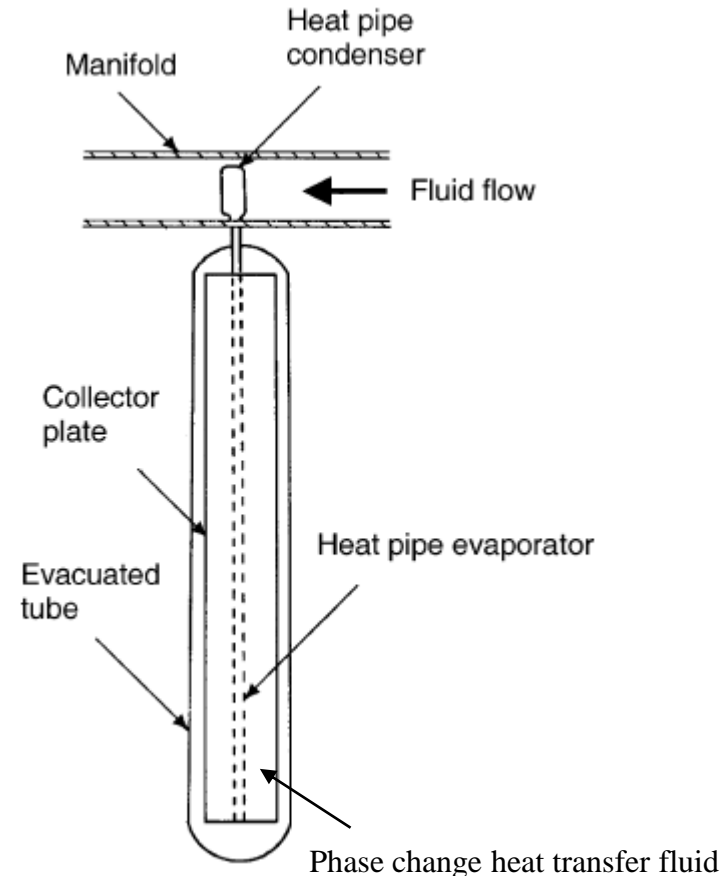

Conversion pathways: Solar to thermal

- Solar to thermal: non or low-concentrating
 - Evacuated tubular collector: typical absorber configurations
 - Metal-fin-in-vacuum tubes
 - Requires glass-metal seal

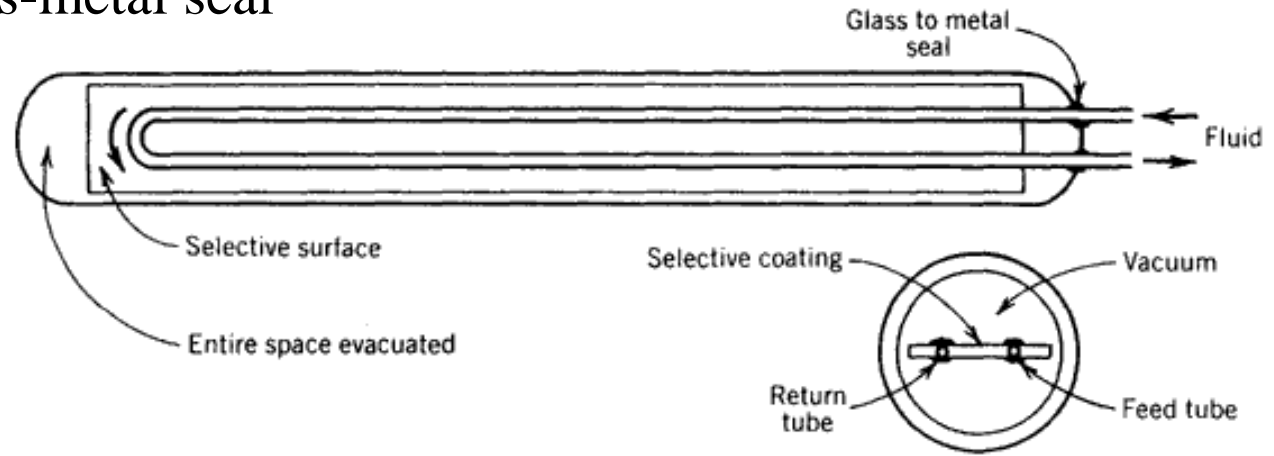

- Dewar tubes

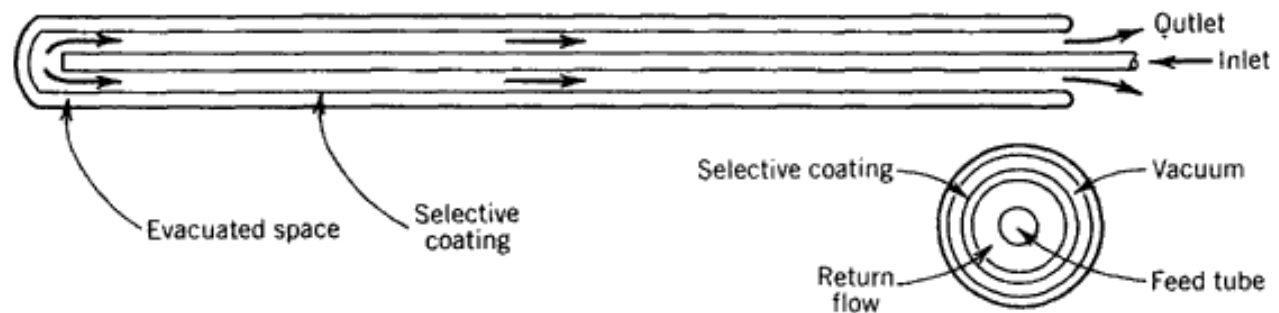

Conversion pathways: Solar to thermal

- Evacuated tubular collector:



Source: SunBest

Conversion pathways: Solar to thermal

- Solar to thermal: non or low-concentrating
 - 2D compound parabolic concentrator (CPC)
 - Direct and some diffuse radiation
 - Advantage:
 - Higher performance
 - Higher temperatures
 - Temperature range: 60-240°C
 - Concentration: 1-5

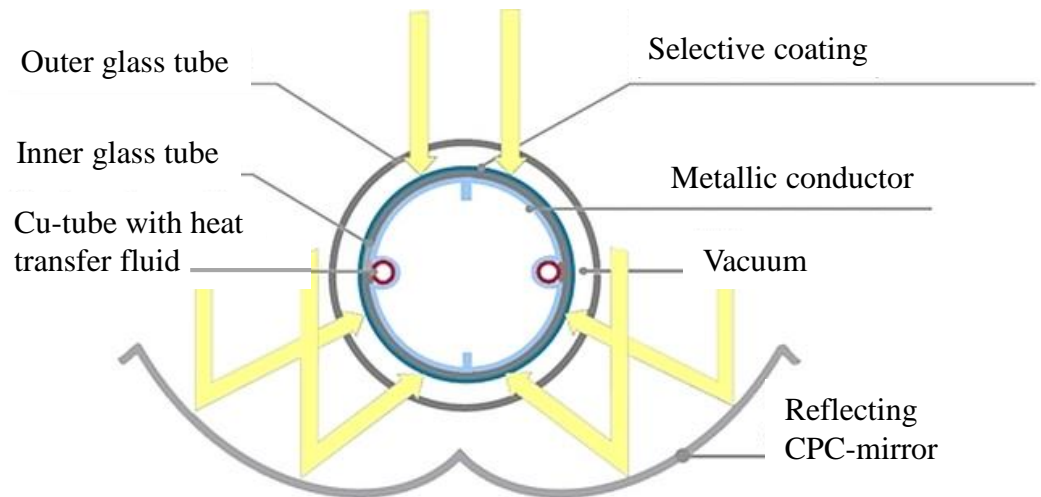

Conversion pathways: Solar to thermal

- Solar to thermal: non or low-concentrating
 - 2D compound parabolic concentrator

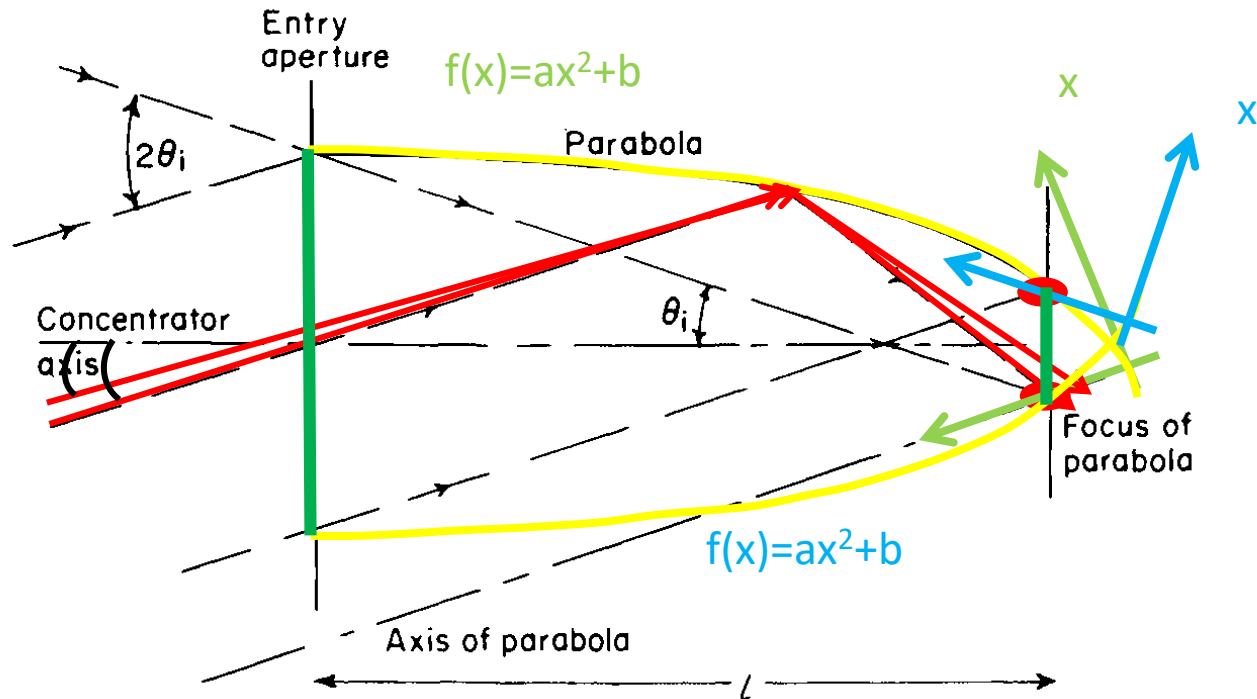

- All radiation within CPC incidence angle will be concentrated

Conversion pathways: Solar to thermal

- Solar to thermal: non or low-concentrating
 - 2D compound parabolic concentrator
 - Acceptance angle Φ
 - Concentration, $C = 1/\sin(\Phi)$
 - Outlet radius, $r_{\text{out}} = r_{\text{in}} \cdot \sin(\Phi)$
 - Length, $L = (r_{\text{in}} + r_{\text{out}}) \cdot \cot(\Phi)$
 - r and z coordinates

$$r = \frac{2r_{\text{out}} (1 + \sin(\Phi)) \sin(\varphi + \Phi)}{1 - \cos(\varphi)} - r_{\text{out}}$$

$$z = \frac{2r_{\text{out}} (1 + \sin(\Phi)) \cos(\varphi + \Phi)}{1 - \cos(\varphi)}$$

with $2\Phi < \varphi < \Phi + \pi / 2$

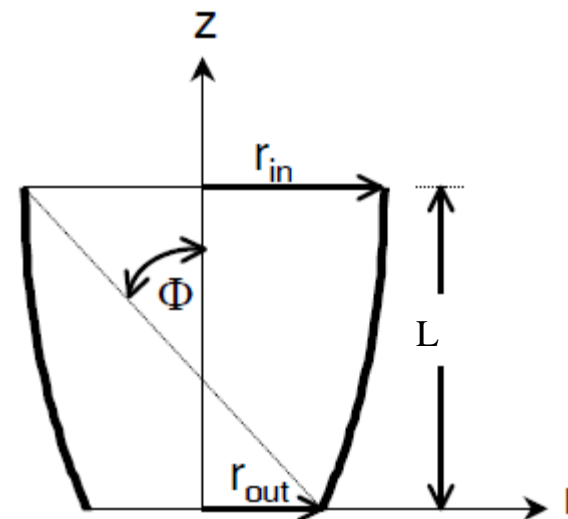

Conversion pathways: Solar to thermal

- Solar to thermal: non or low-concentrating
 - 2D compound parabolic concentrator: typical absorber configurations

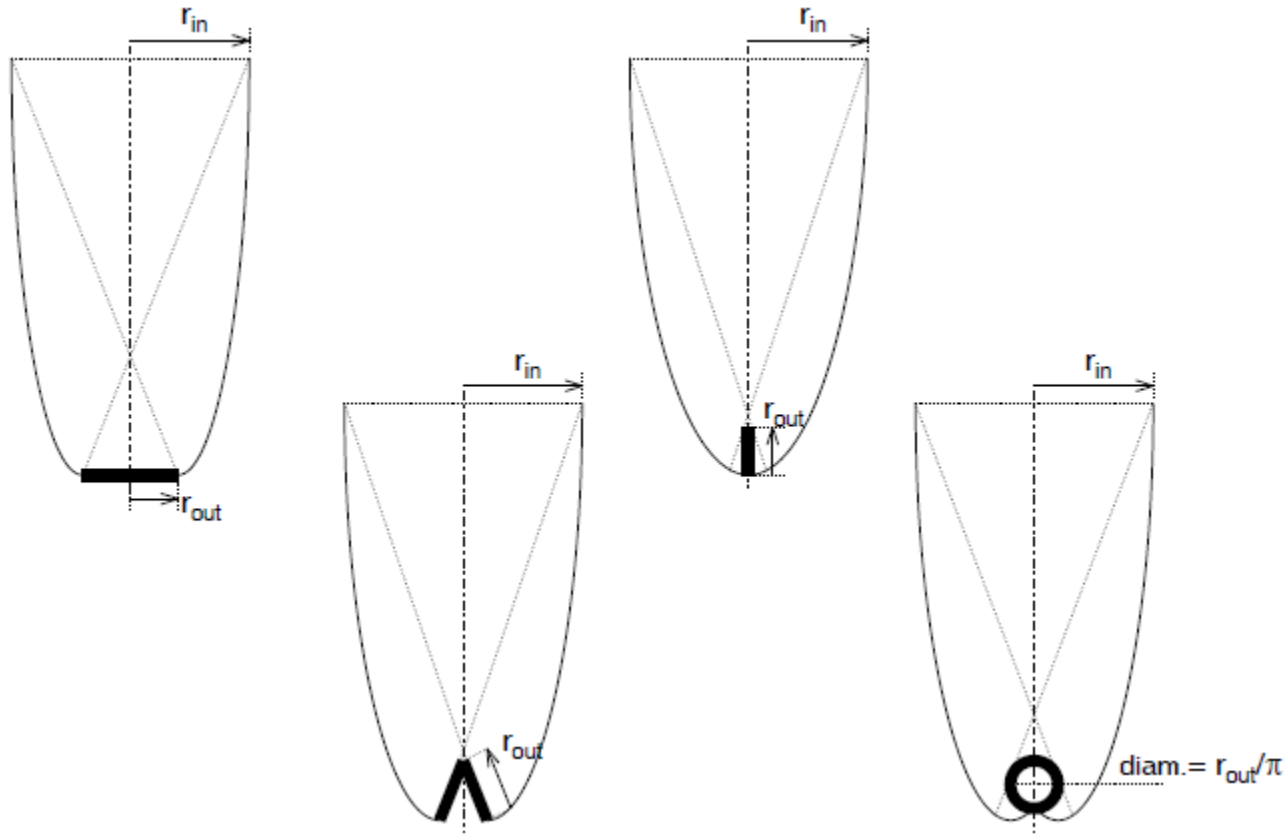

Conversion pathways: Solar to thermal

- Solar to thermal: non or low-concentrating
 - 2D compound parabolic concentrator
 - Tubular receiver radius, r
 - Acceptance angle, θ_a
 - x and y coordinates

$$x = r [\sin(\theta) - M(\theta) \cdot \cos(\theta)]$$

$$y = r [-\cos(\theta) - M(\theta) \cdot \sin(\theta)]$$

with

$$M(\theta) = \begin{cases} \theta & \text{for } 0 \leq \theta \leq \pi/2 \\ \frac{\pi/2 + \theta_a + \theta - \cos(\theta - \theta_a)}{1 + \sin(\theta - \theta_a)} & \text{for } \pi/2 \leq \theta \leq 3\pi/2 - \theta_a \end{cases}$$

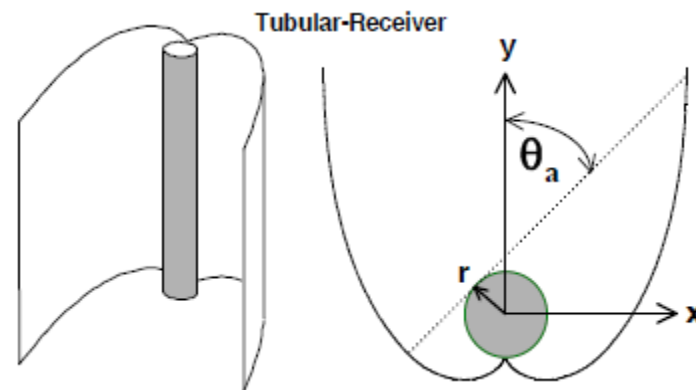

Conversion pathways: Solar to thermal

- Solar to thermal: non or low-concentrating
 - Compound parabolic concentrator:

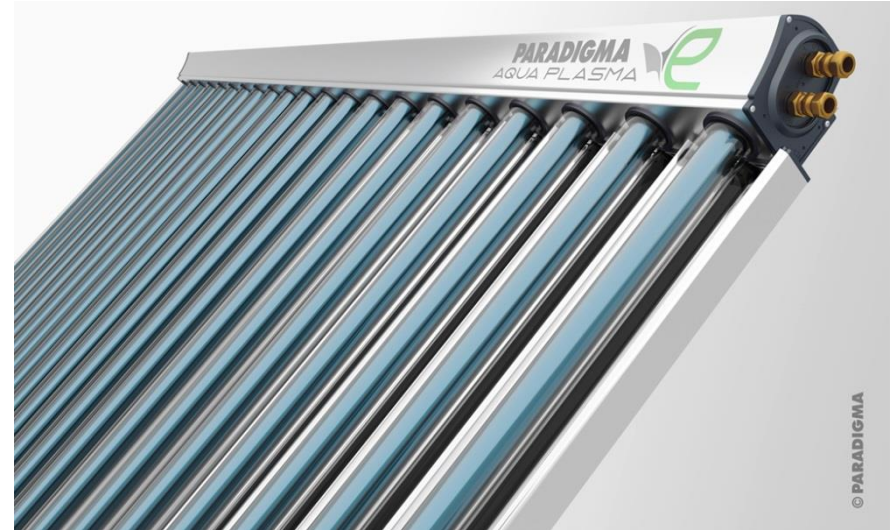

Conversion pathways: Solar to thermal

- Solar to thermal: non or low-concentrating
 - Global installed capacity of water and air collectors by 2018 (480 GW):

FIGURE 32. Solar Water Heating Collectors Global Capacity, 2008-2018

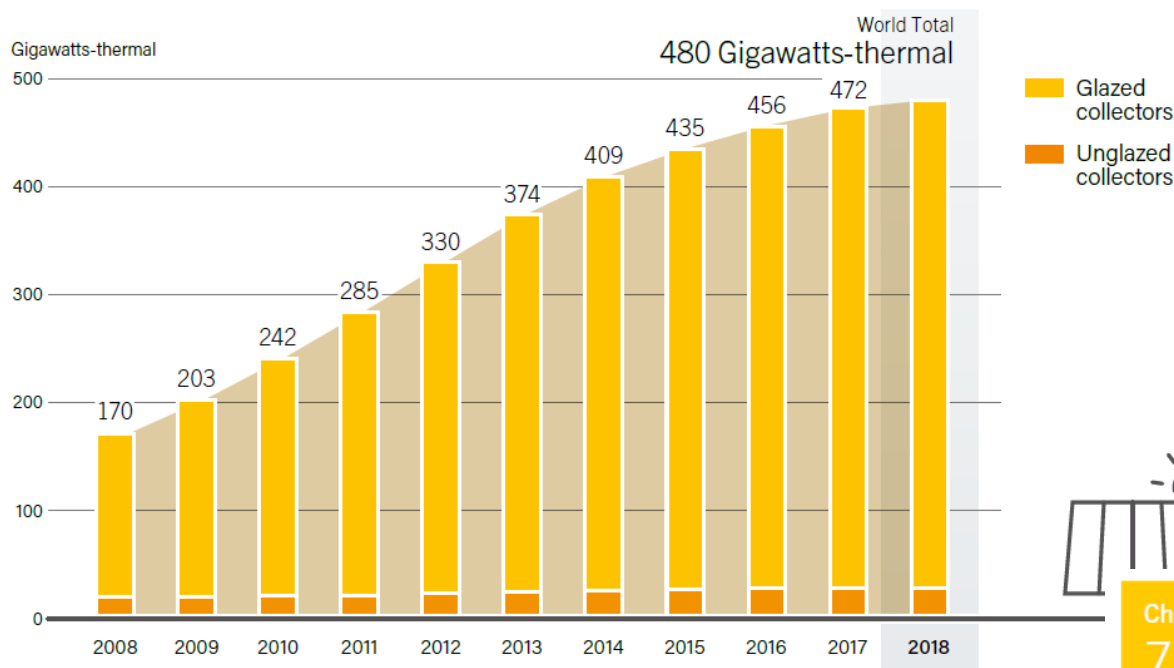

REN21, Renewable 2019 Global Status Report

Note: Data are for glazed and unglazed solar water collectors and do not include concentrating and air collectors.

Source: IEA SHC. See endnote



Where:
(2017)

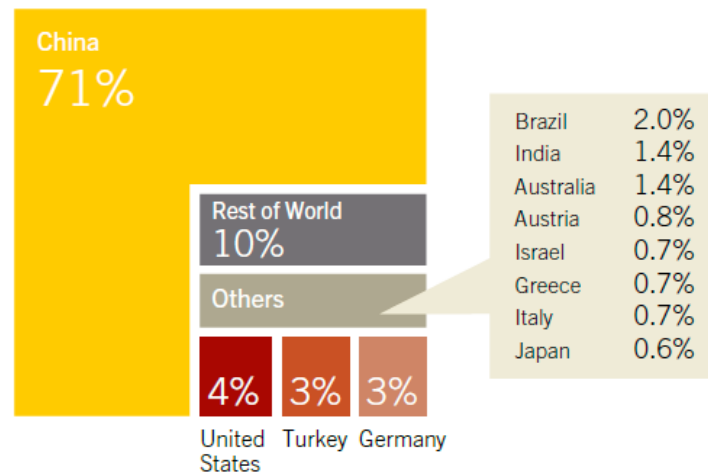

Conversion pathways: Solar to thermal

- Solar to thermal: non or low-concentrating
 - Installed capacity of glazed and evacuated tubes per capita by 2009:

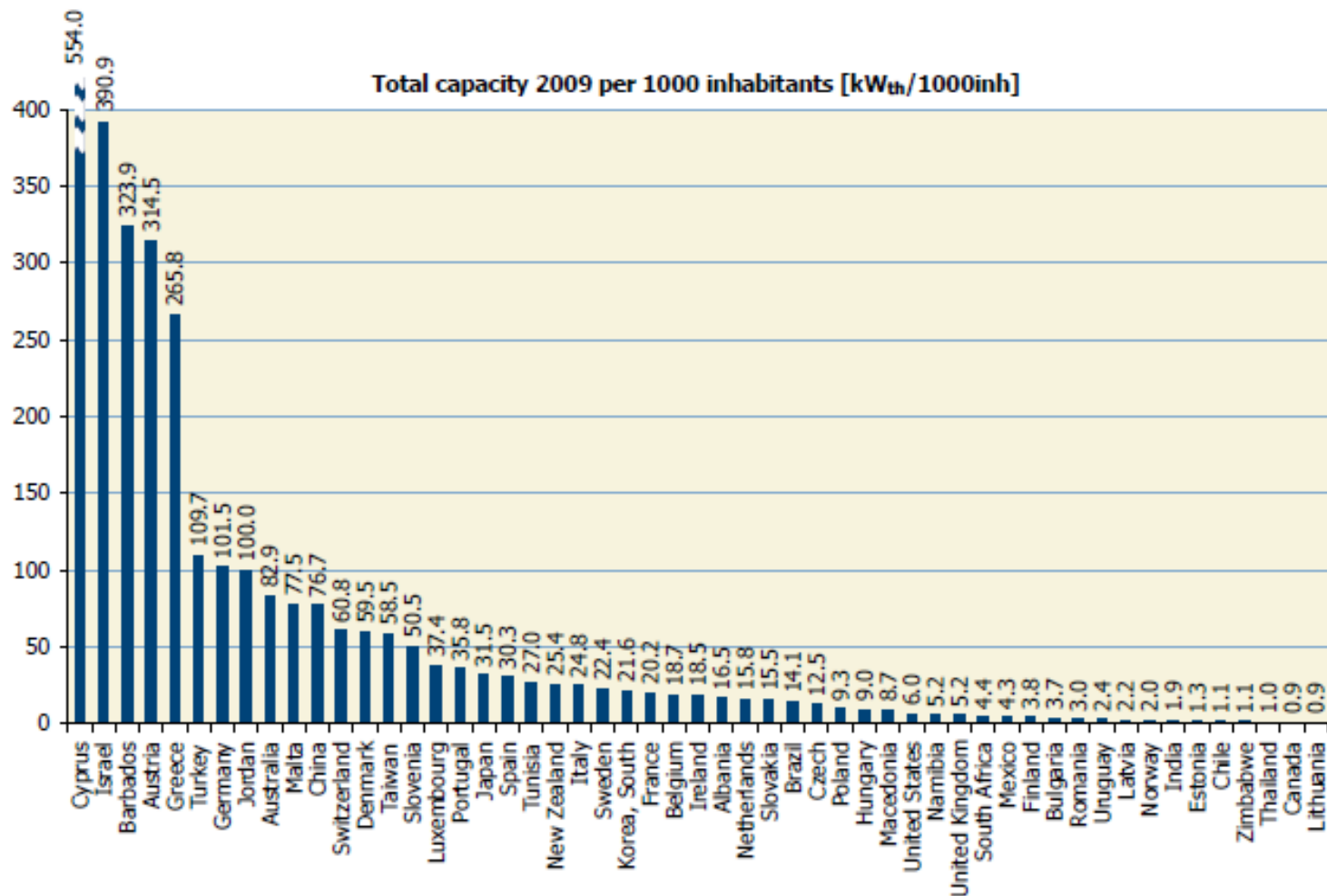

Weiss and Mauthner, Solar Heat Worldwide, Solar heating and cooling, IEW, 2011

Conversion pathways: Solar to thermal

- Solar to thermal:
 - non or low-concentrating
 - concentrating

Conversion pathways: Solar to thermal

- Solar to thermal: Why (high) concentrated radiation?
- Concentration is achieved by interposing an optical device between the source of radiation and the energy absorbing surface
- Advantages:
 - Higher temperatures/efficiencies achievable
 - Smaller areas: (i) smaller infrared losses and (ii) cheaper systems, or expensive processing steps are more viable
 - Reflecting surfaces require less material and are structurally simpler than collectors
- Disadvantages:
 - Concentrator systems collect little diffuse radiation
 - Tracking required to enable the collector to follow the sun
 - Performance of reflecting surfaces decreases with time

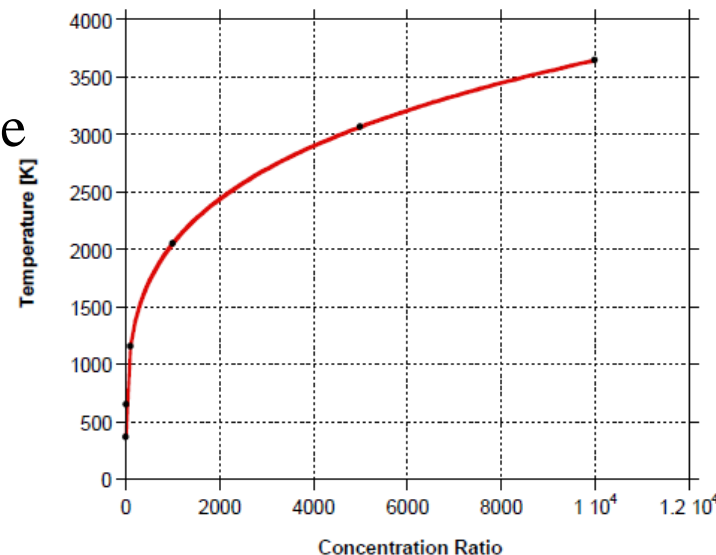

Conversion pathways: Solar to thermal

- Solar to thermal: concentrated radiation

- Power generation

$$\eta_{\text{rec}} = \frac{q_{\text{use}}}{q_{\text{sol,in}}} = \frac{q_{\text{use}}}{CI} = \alpha - \sigma\epsilon \frac{T_{\text{abs}}^4 - T_{\text{amb}}^4}{CI}$$

$$\eta_{\text{heat-to-electricity}} = \frac{T_{\text{abs}} - T_{\text{amb}}}{T_{\text{abs}}}$$

- Optimum temperature (temperature high)

but reradiation losses still low:

$$\frac{d(\eta_{\text{rec}} \eta_{\text{heat-to-electricity}})}{dT_{\text{abs}}} = 0$$

$$4\sigma T_{\text{abs}}^5 - 3\sigma\epsilon T_{\text{amb}} T_{\text{abs}}^4 - (\sigma T_{\text{amb}}^5 + \alpha C I T_{\text{amb}}) = 0$$

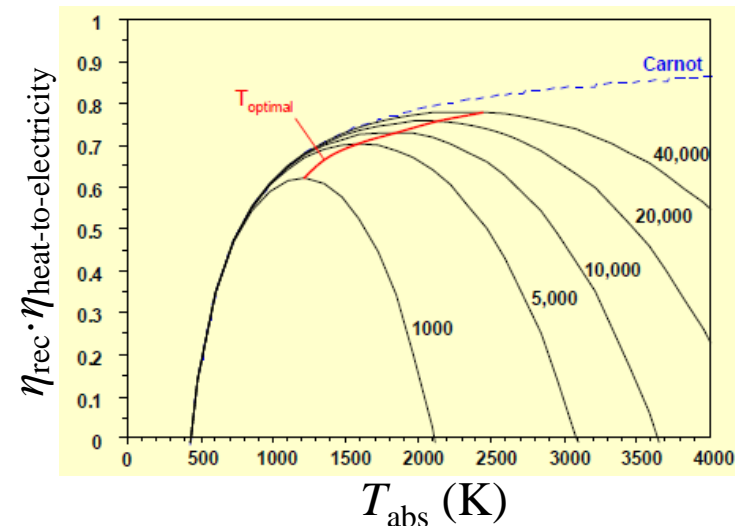
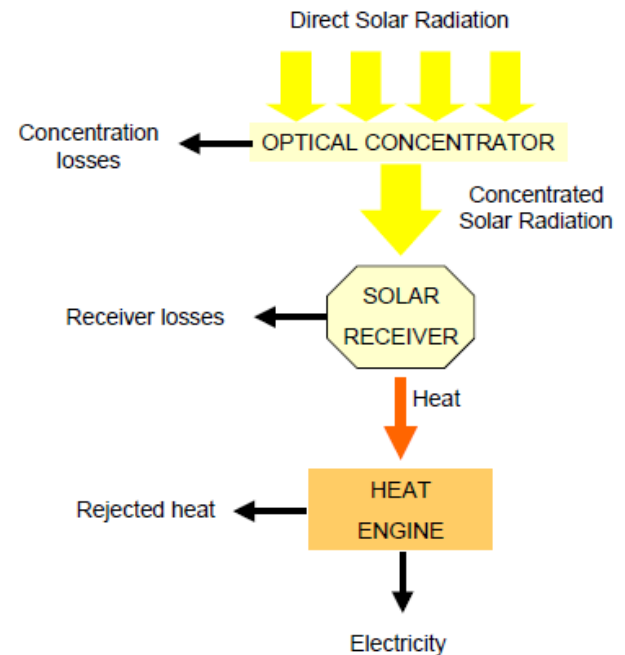

Conversion pathways: Solar to thermal

- Solar to thermal: concentrated radiation

- Concentration limits

- Thermodynamic concentration limit

2-axis tracking: $C_{\max} = \frac{4\pi r^2}{4\pi D^2} = 1 / \sin^2(\theta_s) = 46'200$

1-axis tracking: $C_{\max} = \frac{2\pi r}{2\pi D} = 1 / \sin(\theta_s) = 215$

- Solar irradiation is not perfectly collimated but has solid angle (θ), leading to focal spot not point

- Concentration limitations:

3D concentrator: $C_{\max} = \frac{\sin^2(2\Phi)}{4\sin^2(\theta_s)}$

2D concentrator: $C_{\max} = \frac{\sin(2\Phi)}{2\sin(\theta_s)}$

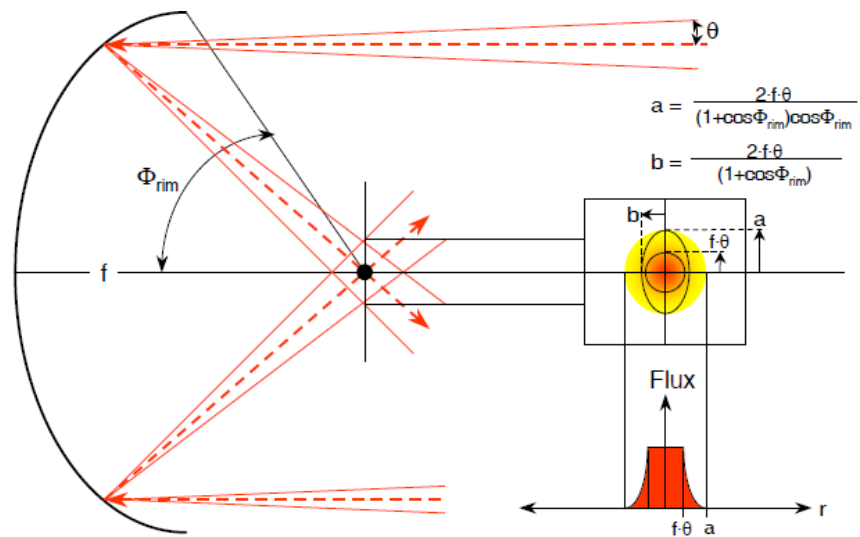
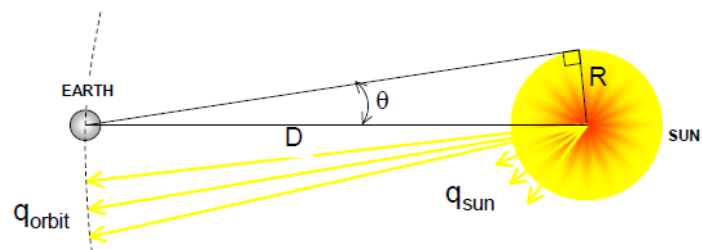

Conversion pathways: Solar to thermal

- Solar to thermal: concentrated radiation
 - Concentrating technology: parabolic trough
 - Line focusing
 - $C = 30 - 80$
 - Unit 30 - 80 MW
 - Temperatures 60–300°C
 - Unidirectional trough
 - curvature
 - 1-axis tracking N-S

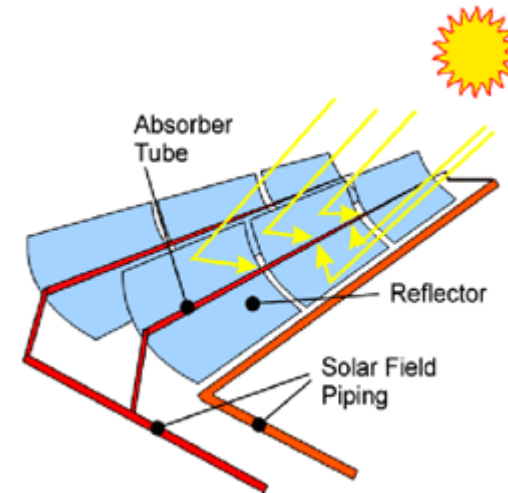

Conversion pathways: Solar to thermal

- Solar to thermal: concentrated radiation
 - Concentrating technology: linear fresnel
 - Line focusing
 - $C = 30 - 80$
 - Unit 30 - 80 MW
 - Temperatures 60–250°C
 - Unidirectional trough
 - 1-axis tracking N-S

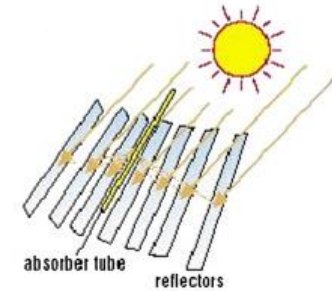

Conversion pathways: Solar to thermal

- Solar to thermal: concentrated radiation
 - Concentrating technology: towers
 - Point focusing
 - $C = 200 - 1000$
 - Unit 10 - 200 MW
 - Temperatures 300–1000°C
 - 2-axis tracking heliostats

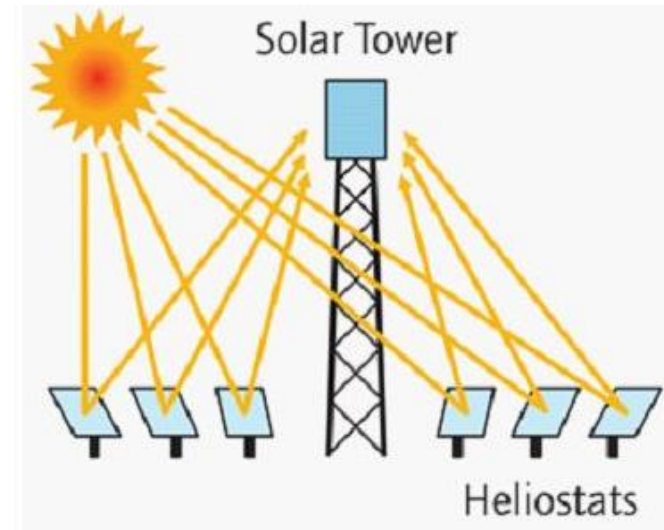

Conversion pathways: Solar to thermal

- Solar to thermal: concentrated radiation
 - Concentrating technology: dishes
 - Point focusing.
 - $C = 1000 - 4000$
 - Unit 5 - 25 kW
 - 2-axis tracking parabolic dish
 - Autonomous power generation via Stirling engines or Brayton miniturbines
 - Modularity
 - Remote applications

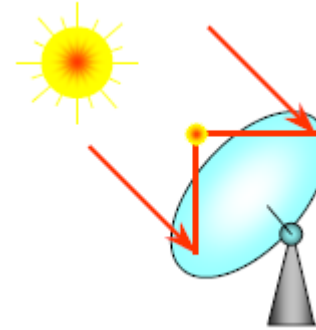

Use of solar heat / residential & industry heat

- For residential applications:

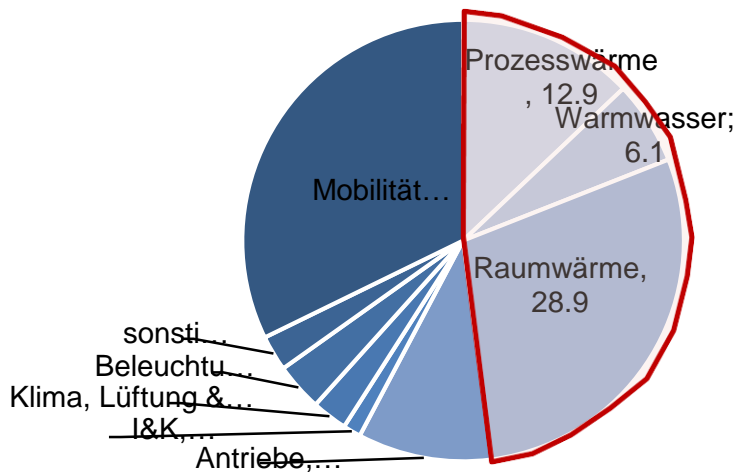

~50% of final energy used for heating services

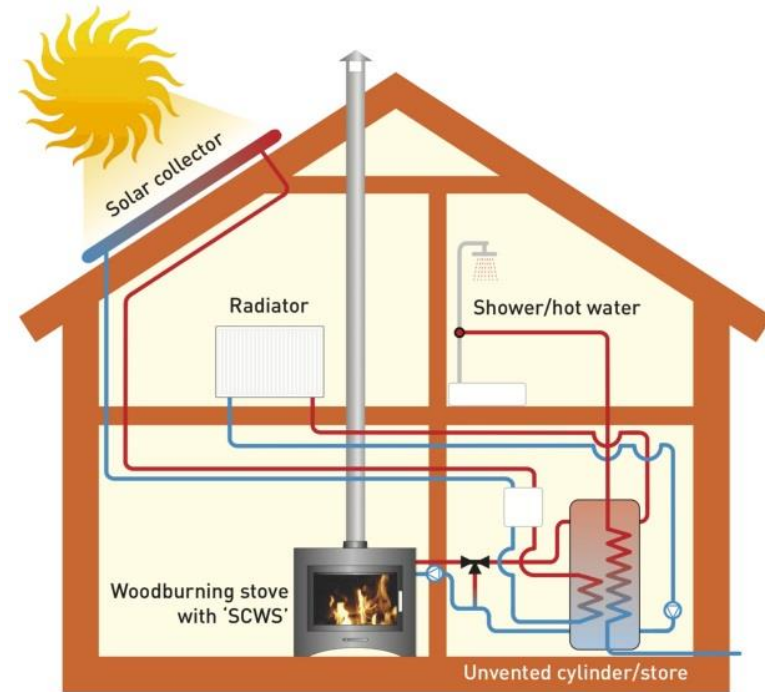

Source: Brosley

¹Swiss Federal Office of Energy, *Analyse des schweizerischen Energie-verbrauchs nach Verwendungszwecken*, October 2015

Use of solar heat / residential & industry heat

- Largest solar district heating plant in Silkeborg, Denmark:
 - Flat plate collectors
 - 156'694 m²
 - 110 MW_{th}
 - Covers 20% of heating demand of 43'000 users
 - No seasonal heat storage, day-time storage only
 - Operation since 2017



Use of solar heat / residential & industry heat

- Industry: capacity of 143 MW_{th} in 2017 of concentrating technology for industrial heating applications

- Miraah solar thermal plant

Mirrors in a greenhouse

For thermal enhanced oil recovery

4 units (100 MW_{th}) inaugurated in early 2018

1.9 km² are planned for total of 1GW_{th}



- Emmi Dairy Saignelégier

For dairy production

627 m², 360 kW_{th}



- Database for Solar Heat for Industrial Processes (SHIP): <http://ship-plants.info/>

Use of solar heat / electricity

- Concentrated Solar Power (CSP): use concentrating technology and connect to thermal power cycle

- Fresnel

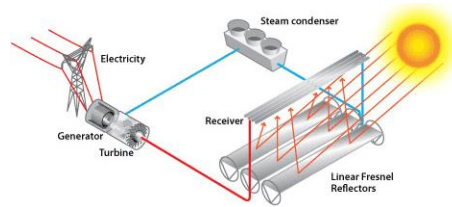

- Parabolic trough

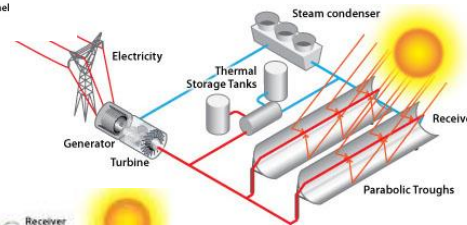

- Tower systems

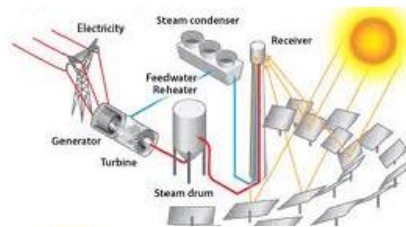

- Dish systems

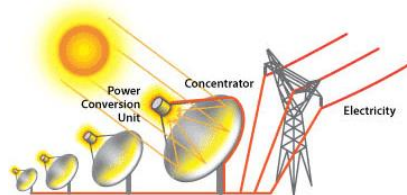

Concentration

Conversion pathways: Solar to thermal

- Solar to thermal: concentrated radiation, parabolic trough
 - SEGS plants in CA: 310 MW_{el}, 1100 GWh/year, hybrid (solar/natural gas), no storage, synthetic oil as HTF (390°C), mean annual efficiency 14%
 - 2 mio m² solar field

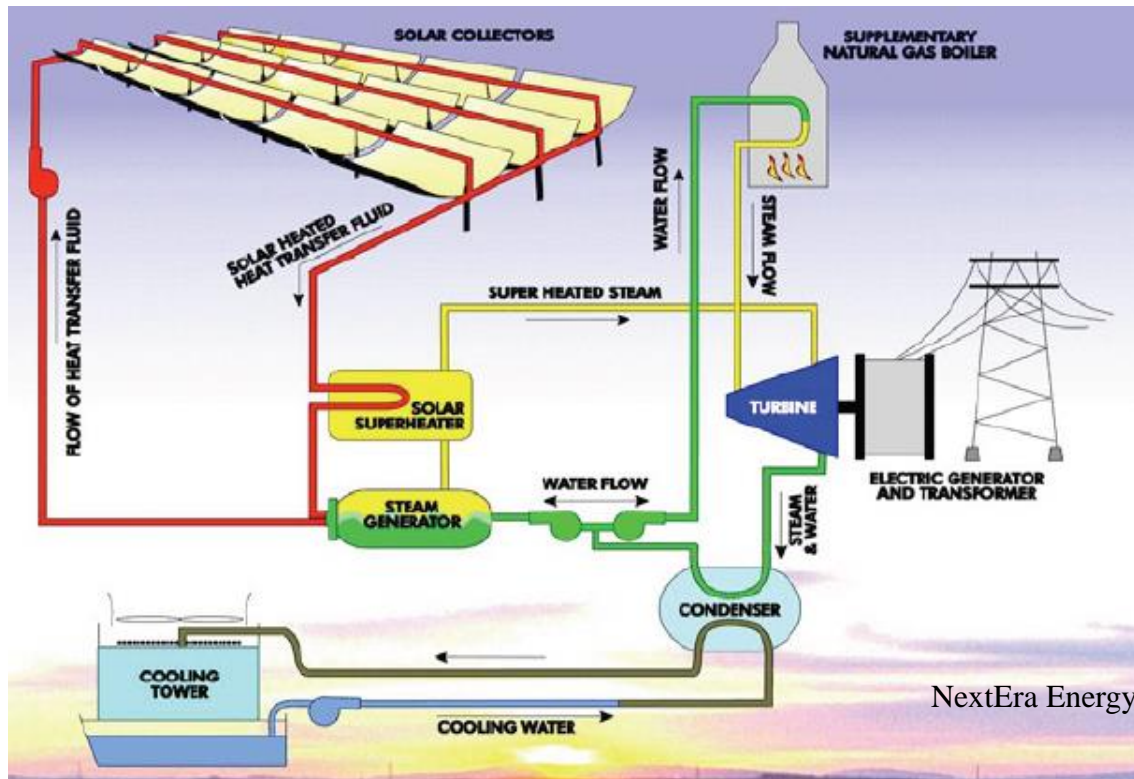

Overview

- » Seven solar facilities operated by a subsidiary of NextEra Energy Resources
- » Located at Kramer Junction (SEGS III-VII) and Harper Lake (SEGS VIII, IX) in California
- » A 310-megawatt solar energy plant with company ownership equivalent to approximately 150 megawatts
- » Covers more than 1,500 acres in the desert
- » More than 900,000 mirrors that capture and concentrate sunlight
- » Can power more than 230,000 homes at peak production during the day
- » Commercial operation began for SEGS III & IV in 1986; SEGS V in 1987; SEGS VI and VII in 1988; SEGS VIII in 1989 and SEGS IX in 1990.

Conversion pathways: Solar to thermal

- Solar to thermal: concentrated radiation, parabolic through
 - Absorber tubes for through concentrator

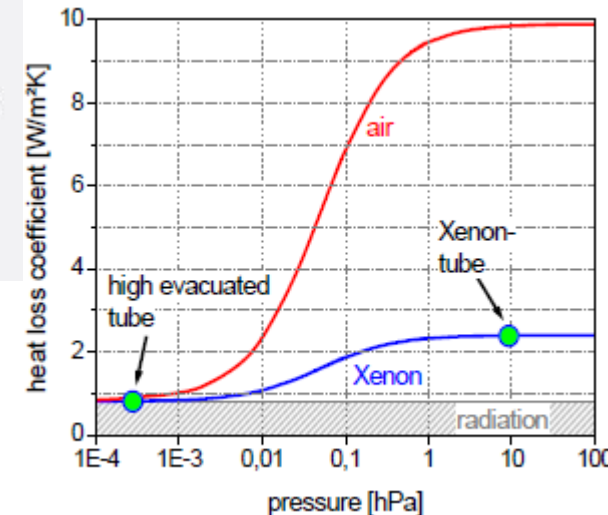
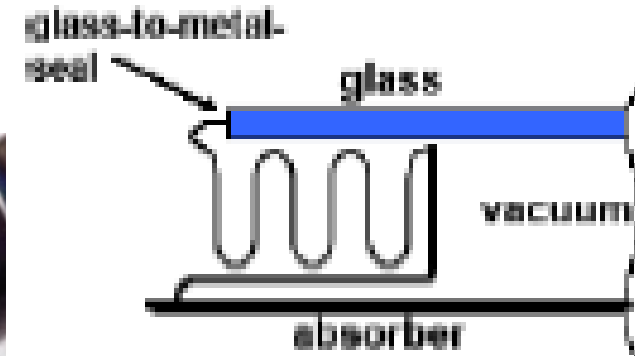
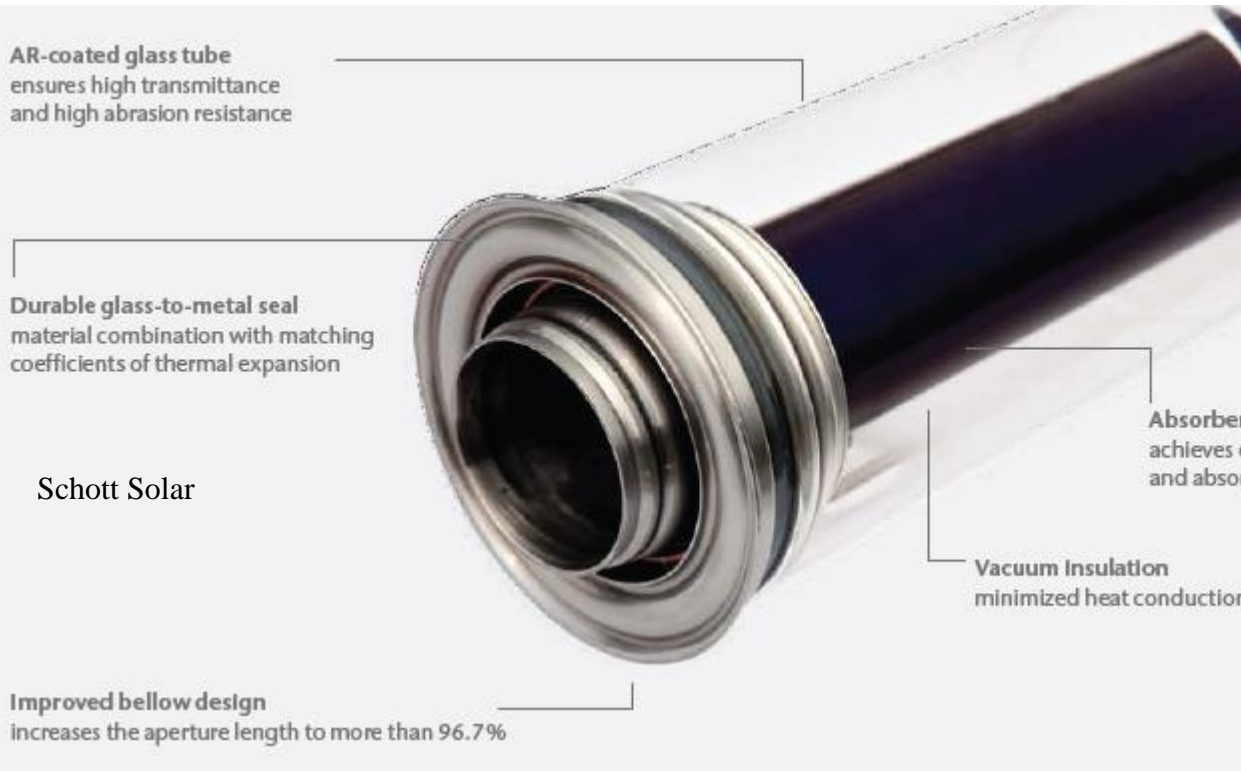

Conversion pathways: Solar to thermal

- Solar to thermal: concentrated radiation
 - Application: concentrated solar power e.g. via Combined cycle

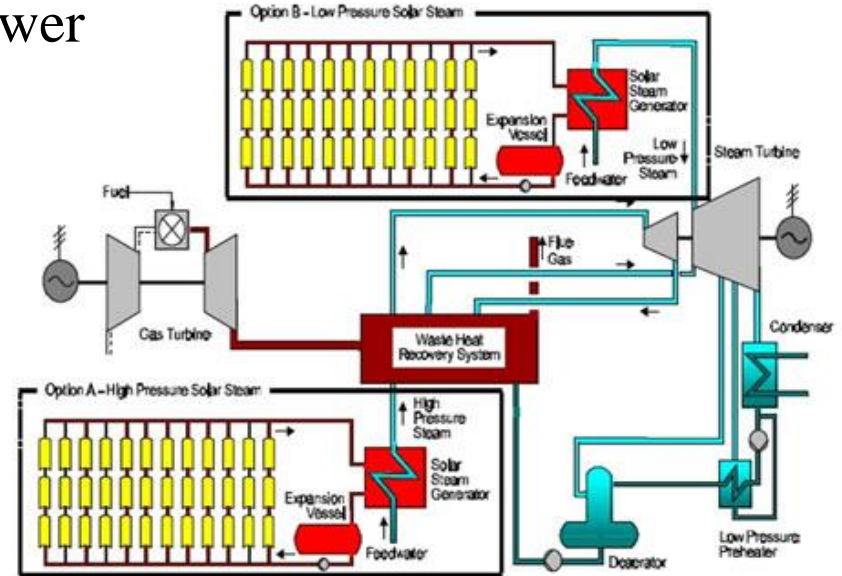
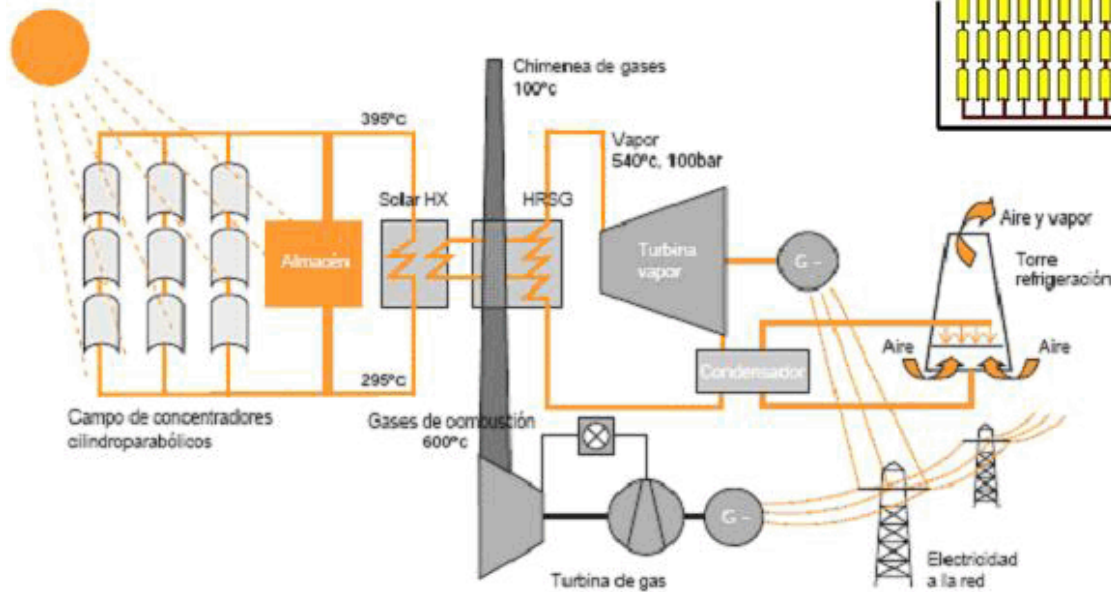

Conversion pathways: Solar to thermal

- Solar to thermal: concentrated radiation, parabolic trough
 - Indirect vs. direct steam generation

Feldhof, SFERA summer school, 2012

Oil as HTF

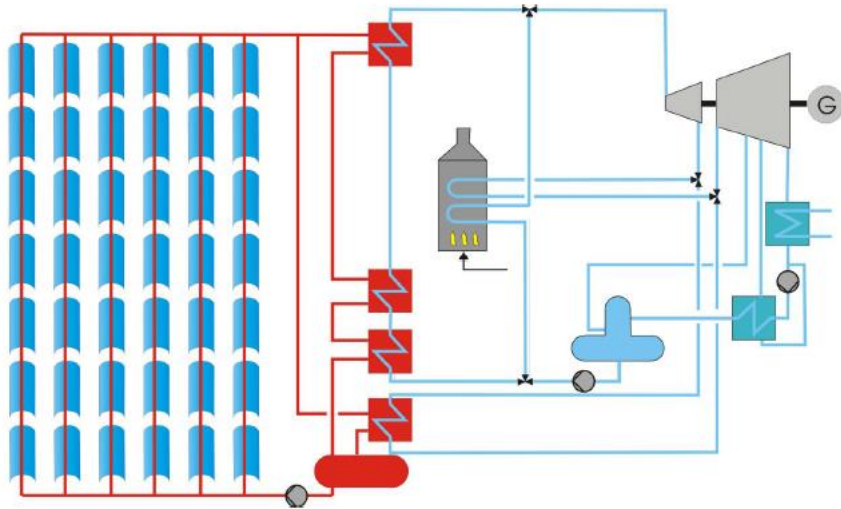

- + Commercially applied
- + One-phase flow
- + Easily scalable
- Heat exchanger batteries
- $T < 400^{\circ}\text{C}$
- Efficiency/process limit reached
- Hazardous to environment

DSG

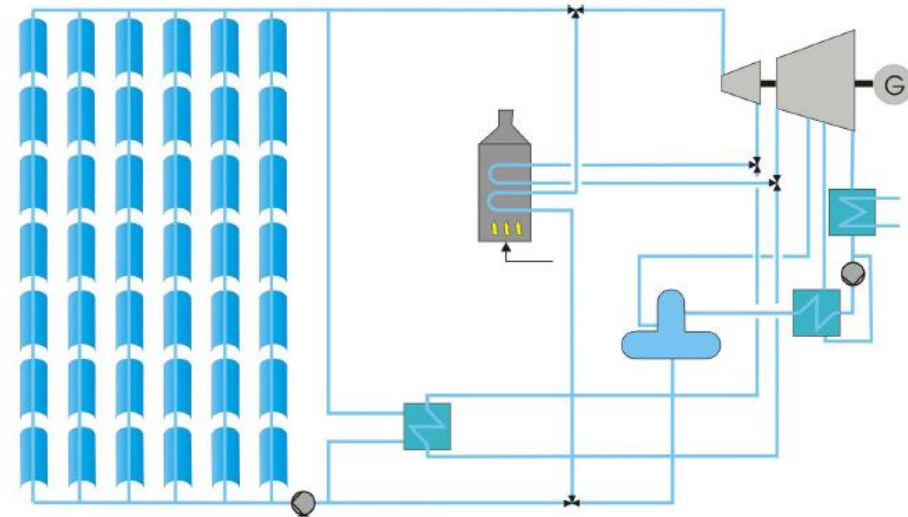

- + No heat exchangers
- + High temperatures
- + High efficiency
- + Non-toxic fluid
- + Simple overall configuration
- Two-phase flow
- Higher control effort
- Thermal storage expensive (so far)
- Higher temperature gradients

Conversion pathways: Solar to thermal

- Solar to thermal: concentrated radiation, parabolic trough
 - Indirect vs. direct steam generation

Feldhof, SFERA summer school, 2012

Flow direction →

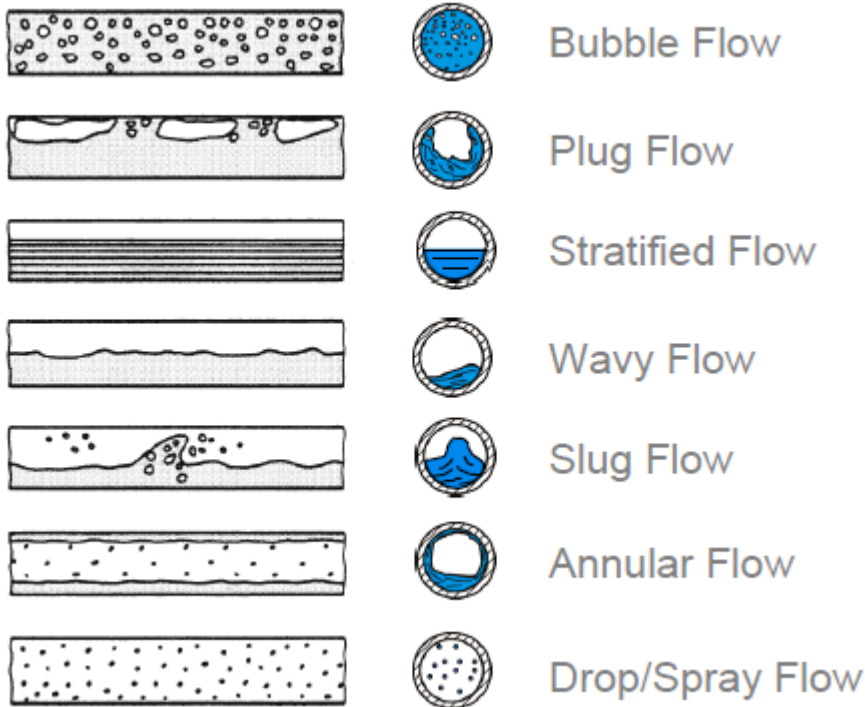

Processes to avoid stratification:

Recirculation



Once-Through (classic)



Injection

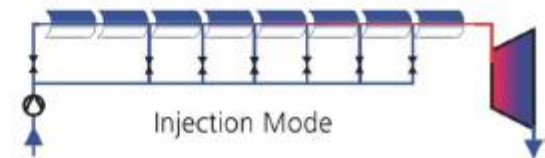

Conversion pathways: Solar to thermal

- Solar to thermal: concentrated radiation, fresnel
 - PE1 in Spain
 - 1.4 MW_{el}
 - 2 GWh/year
 - Water HTF (270°C)
 - Two lines:
 - Line length: 806 m
 - Width: 16 m



Conversion pathways: Solar to thermal

- Solar to thermal: concentrated radiation
 - Application: concentrated solar power (CSP) e.g. via Rankine cycle

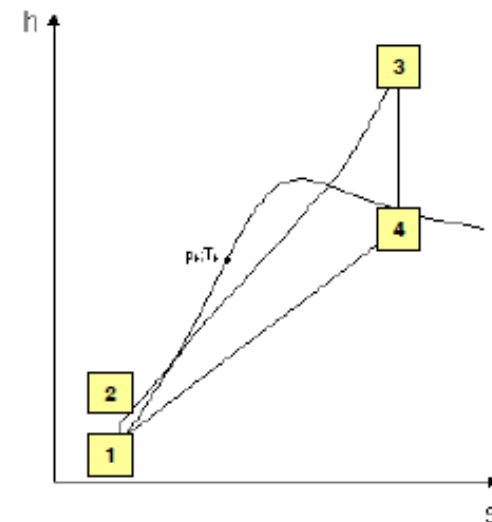
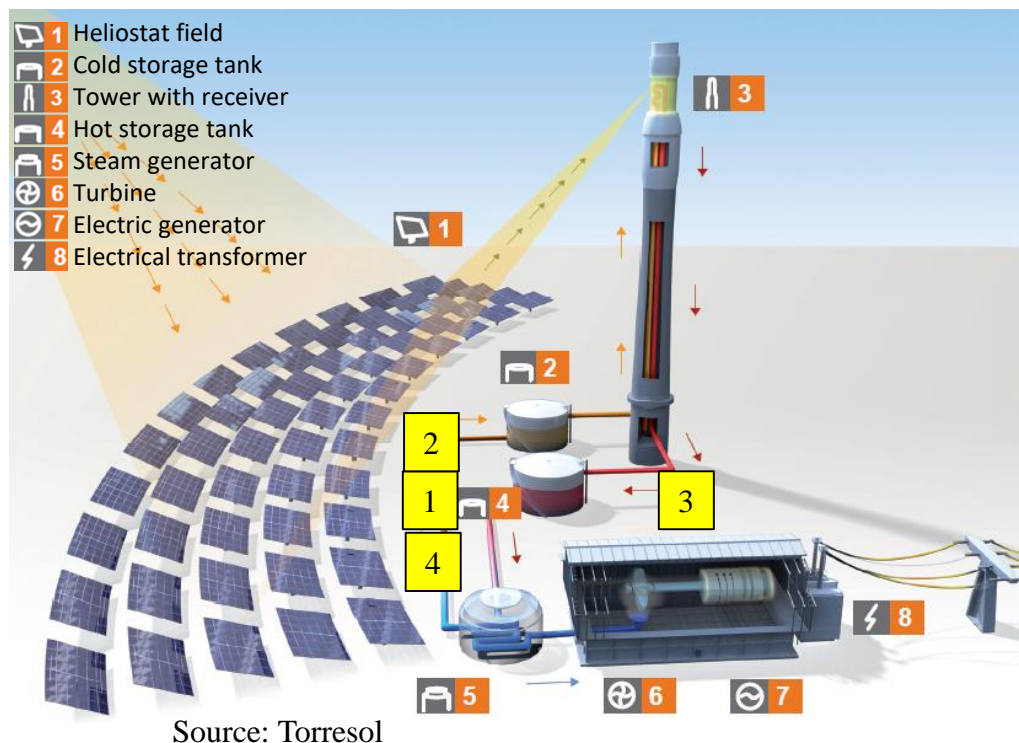

h-s-Diagramm

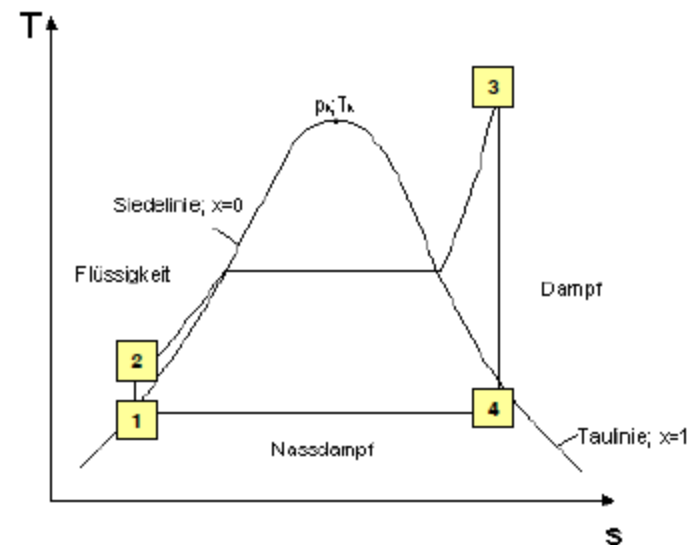

T-s-Diagramm

Conversion pathways: Solar to thermal

- Solar to thermal: concentrated radiation, towers
 - Gemasolar in Spain: 20 MW_{el}, 110 GWh/year, molten salt heat storage, molten salt HTF (565 °C), 2'650 Heliostats (120m² each), tower height 140m

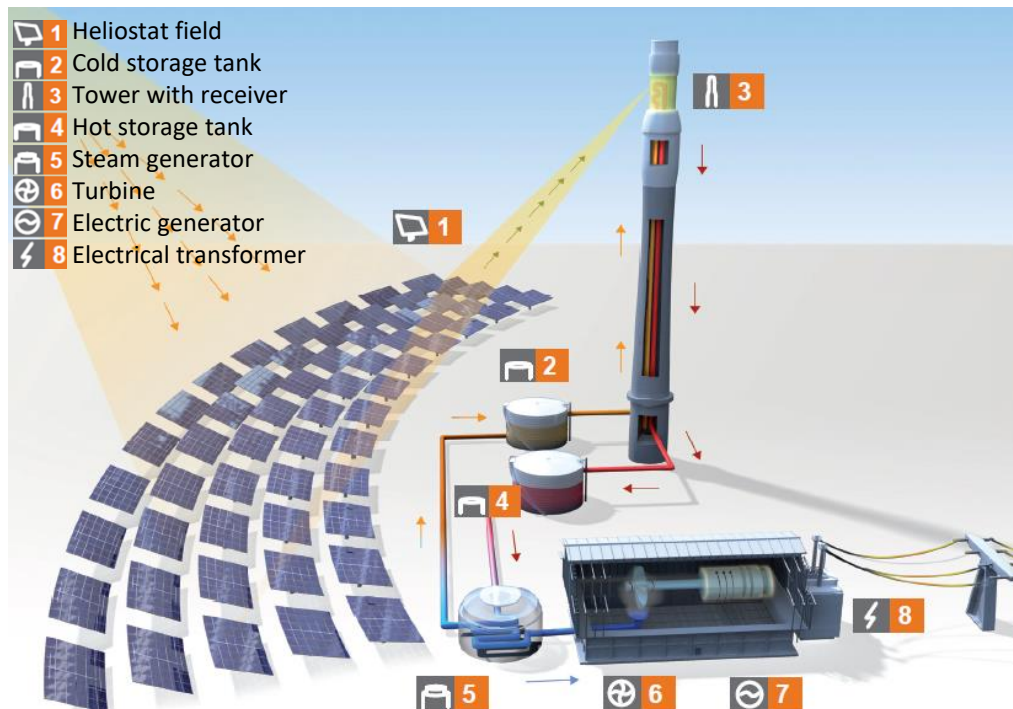

Conversion pathways: Solar to thermal

- Solar to thermal: concentrated radiation, towers
 - Sierra Sun tower, in USA (CA)
 - Two towers
 - 5 MW_{el}
 - Water HTF (440°C)
 - Tower heights 55m
 - Heliostat field: 24000#, 1m^2 each



Conversion pathways: Solar to thermal

- Solar to thermal: concentrated radiation, towers
 - Sierra Sun tower, in USA (CA)

- Three towers
- 377 MW_{el}
- 1079 GWh/year (expected)
- Water HTF (565 °C)
- Direct steam generation in mounted boiler
- Tower heights 140m
- Heliostat field: 173500#, 15m² each

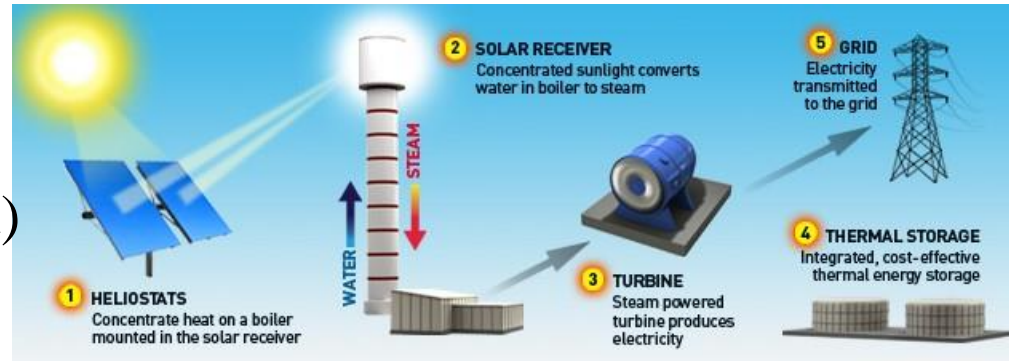

Conversion pathways: Solar to thermal

- Application: CSP e.g. via combined cycle

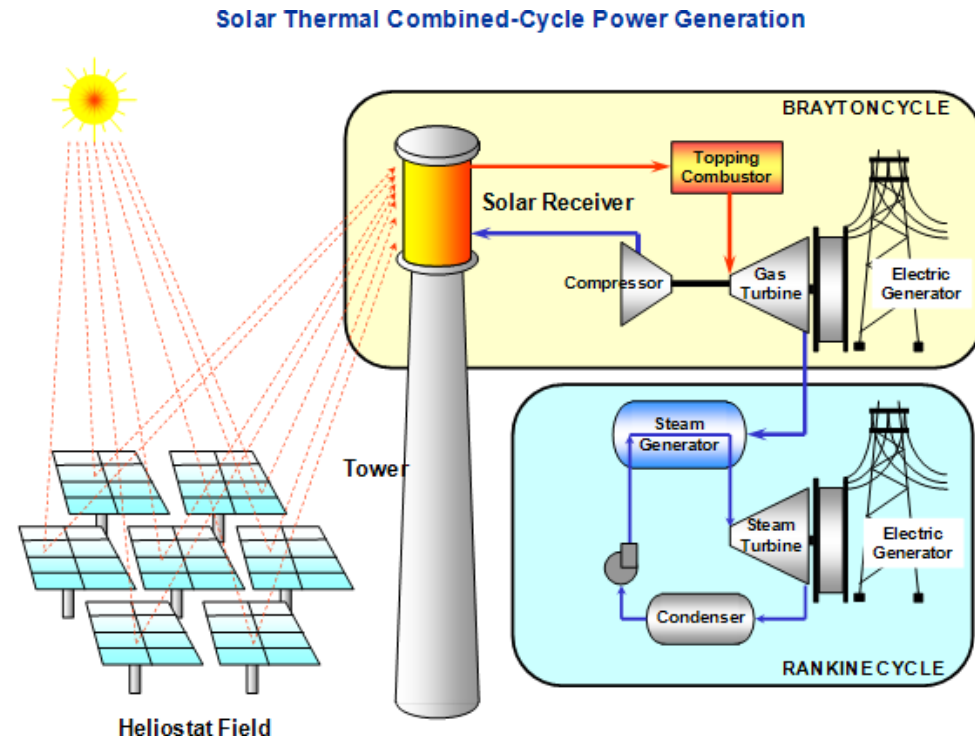
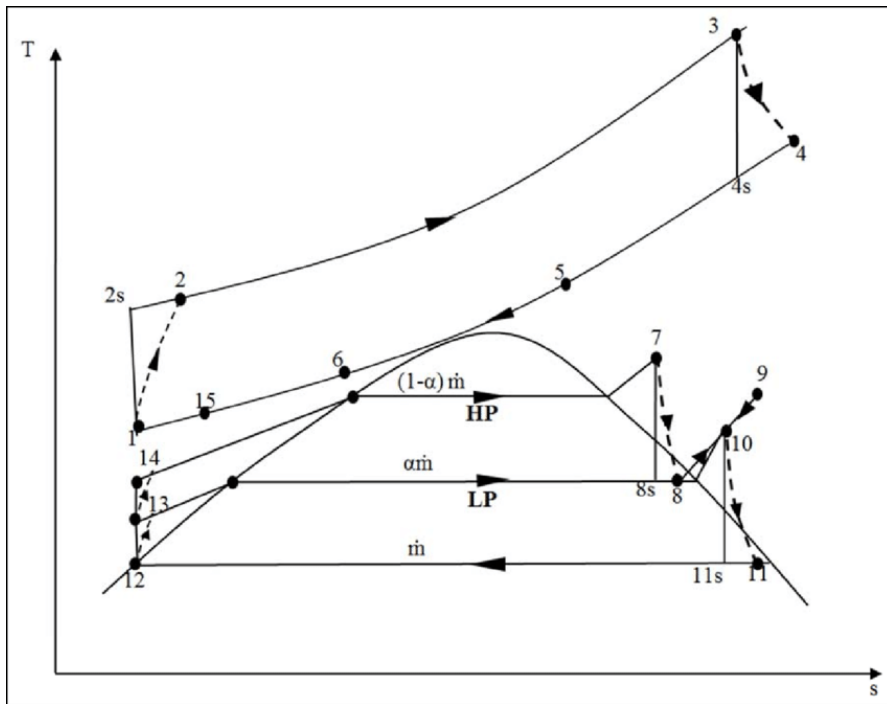

Conversion pathways: Solar to thermal

- Solar to thermal: concentrated radiation, towers
 - PS10 and PS20 in Spain
 - $10 \text{ MW}_{\text{el}}$ and $20 \text{ MW}_{\text{el}}$
 - 23.4 GWh/year and 48 GWh/year
 - Mean annual efficiency 17%
 - Water HTF (250-300°C)
 - Tower heights 115m, 165m
 - Heliostat field:
 - 624#, 120m^2 each
 - 1255#, 120m^2 each



Conversion pathways: Solar to thermal

- Solar to thermal: concentrated radiation, towers



Name	SSPS-CRS	EURELIOS	SUNSHINE	CESA-1	THEMIS	Solar One	Solar Two	SPP-5
Location	Almería	Adrano (Sicily)	Niō Town	Almería	Targasonne	Barstow	Barstow	Shchelkino (Crimea)
Country	Spain	Italy	Japan	Spain	France	USA	USA	Russia
Start of Operation	1981	1981	1981	1983	1982	1982	1996	1986
Electric Output	500 kW _e	1 MW _e	1 MW _e	1 MW _e	2-2.5 MW _e	10 MW _e	10 MW _e	5 MW _e
Heliostat field reflective surface area	3655 m ²	6216 m ²	12912 m ²	11880 m ²	10794 m ²	71447 m ²	71447 m ²	40000 m ²
Receiver heat-transfer fluid	Liquid Sodium	Steam	Steam	Steam	Molten salt (HITEC)	Steam	Molten Salt	Steam
Receiver heat-transfer fluid temperature	530 °C	512 °C	249 °C	525 °C	450 °C	516 °C	565 °C	250 °C
Storage medium	Sodium	HITEC salt / hot water	HITEC salt / hot water	HITEC salt	Molten salt (HITEC)	Oil/rock	Molten Salt	Water / steam
Storage capacity (full power hours)	2	0.5	3	3.5	5	3	3	not available



Conversion pathways: Solar to thermal

- Solar to thermal: concentrated radiation, tower

- Heliostat:

- Field layout:

- North (south) vs. surrounding

Circular

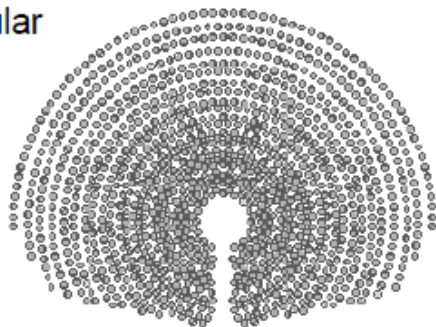

North



- Grid vs. circular

- Mirrors:

- Facetted

- Stretched membrane



Conversion pathways: Solar to thermal

- Solar to thermal: concentrated radiation, tower
 - Receivers
 - Cavity vs. external
 - Radiation and conduction losses smaller
 - Smaller acceptance angle



- Flat vs. cylindrical

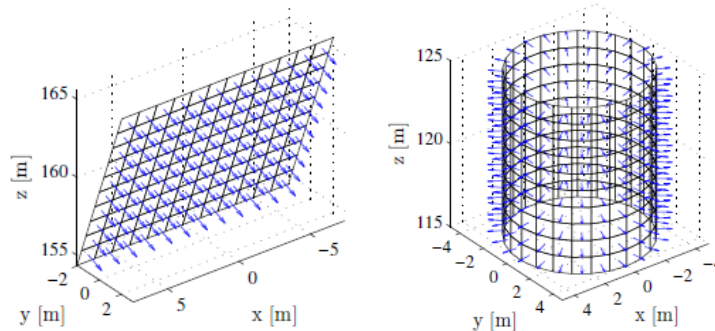

Conversion pathways: Solar to thermal

- Solar to thermal: concentrated radiation, tower
 - Receivers
 - Tube vs. volumetric vs. particles

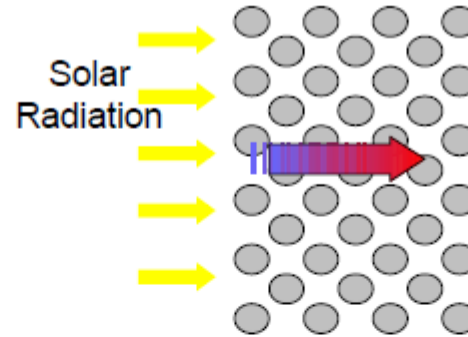
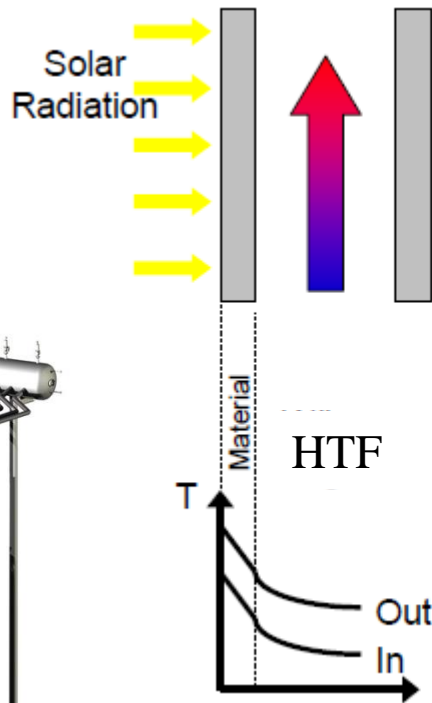

Properties:

- Improved absorption
- Lower extinction
- Higher heat transport
- Higher thermal stability
- Lower cost

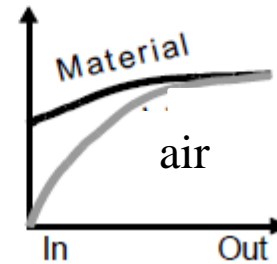

Conversion pathways: Solar to thermal

- Solar to thermal: concentrated radiation, tower
 - Heliostat: losses
 - Shading
 - Cosine losses
 - Reflectivity, cleanliness
 - Blocking
 - Attenuation
 - Spillage

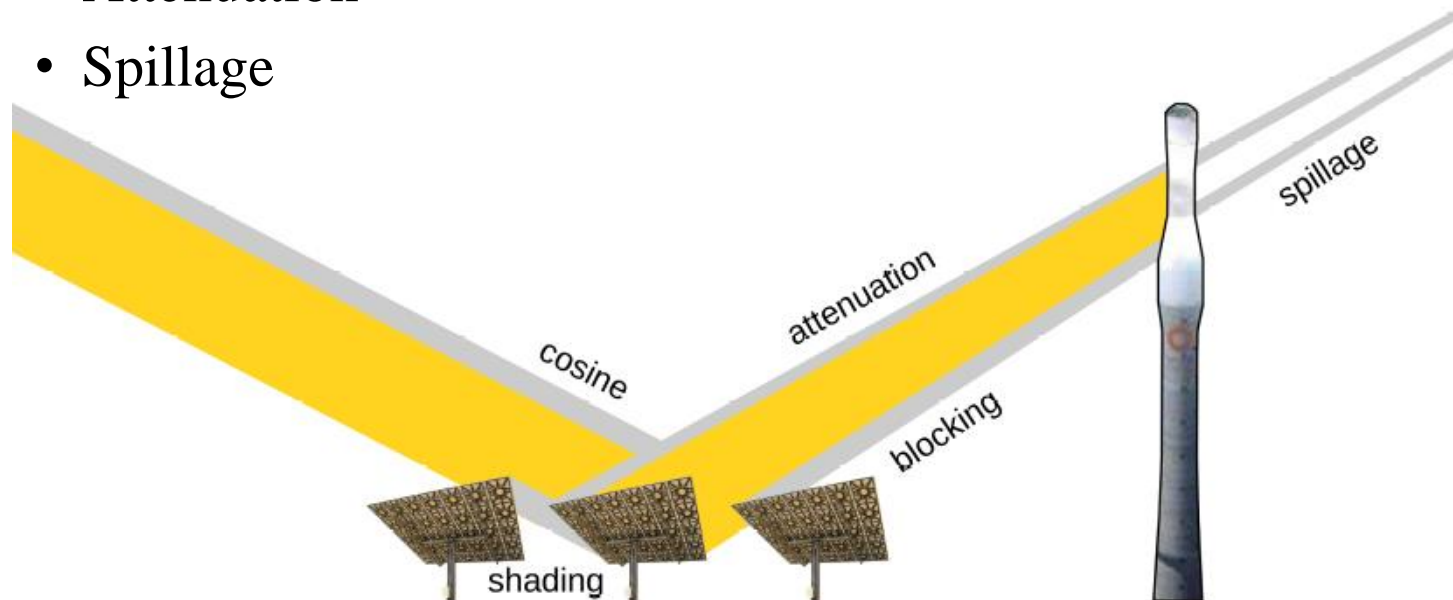

Conversion pathways: Solar to thermal

- Solar to thermal: concentrated radiation, tower
 - Heliostat: losses
 - Gemasolar on March 20 at solar time 07:00, Augsburg 2013

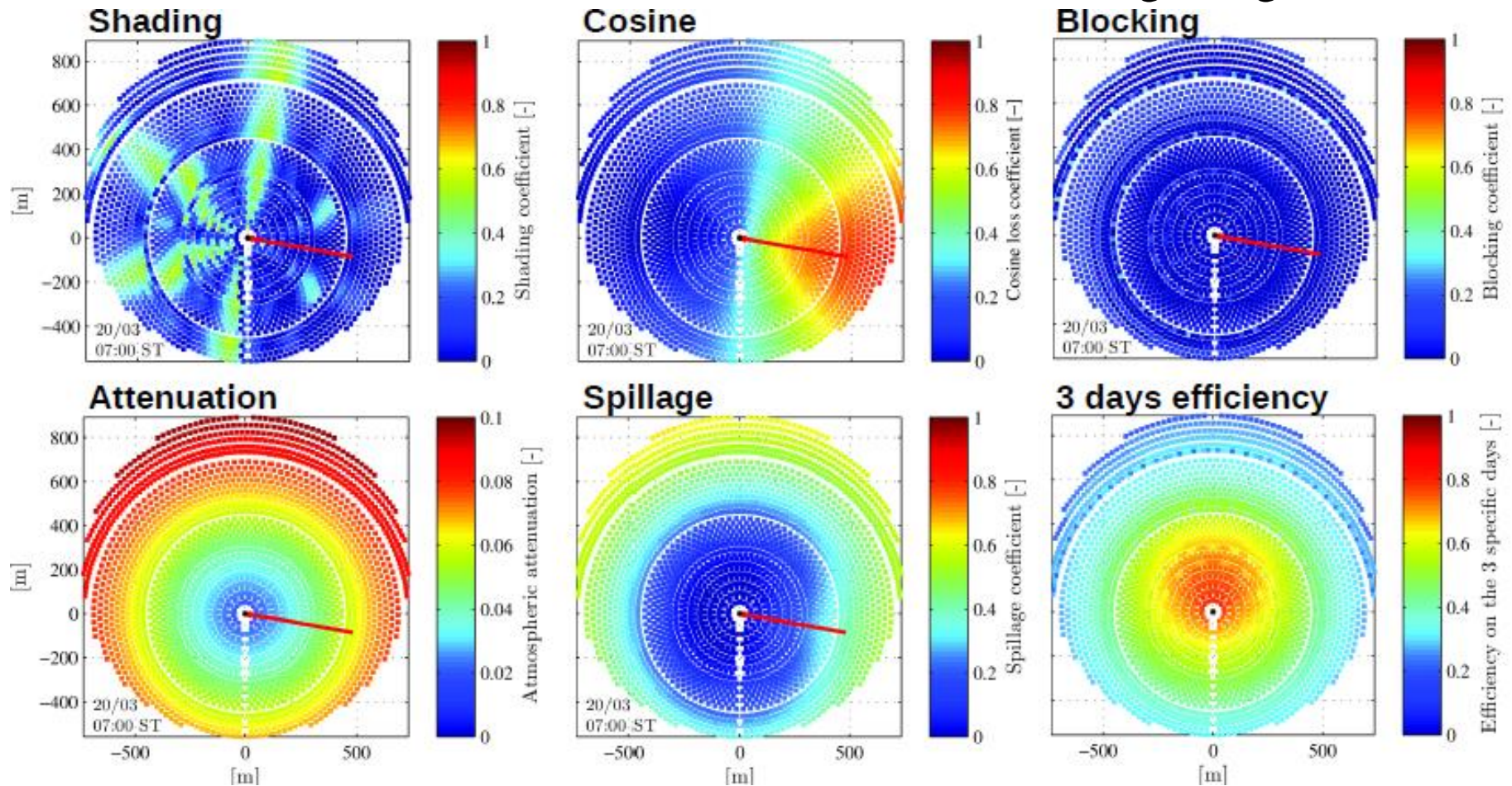

Conversion pathways: Solar to thermal

- Solar to thermal: concentrated radiation, tower
 - Heliostat: losses
 - Average over three days, Augsburg 2013

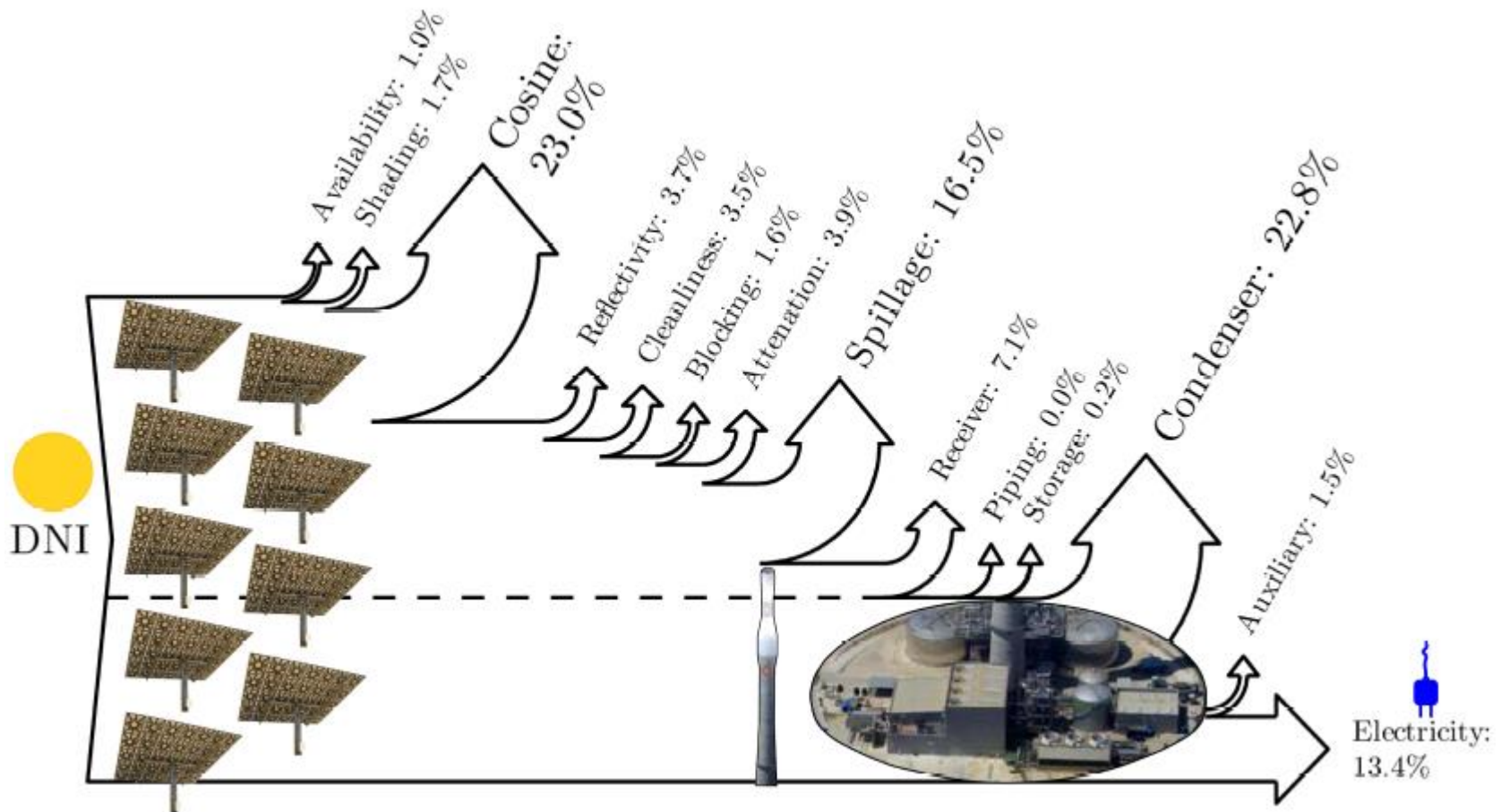

Conversion pathways: Solar to thermal

- Solar to thermal: concentrated radiation, dish

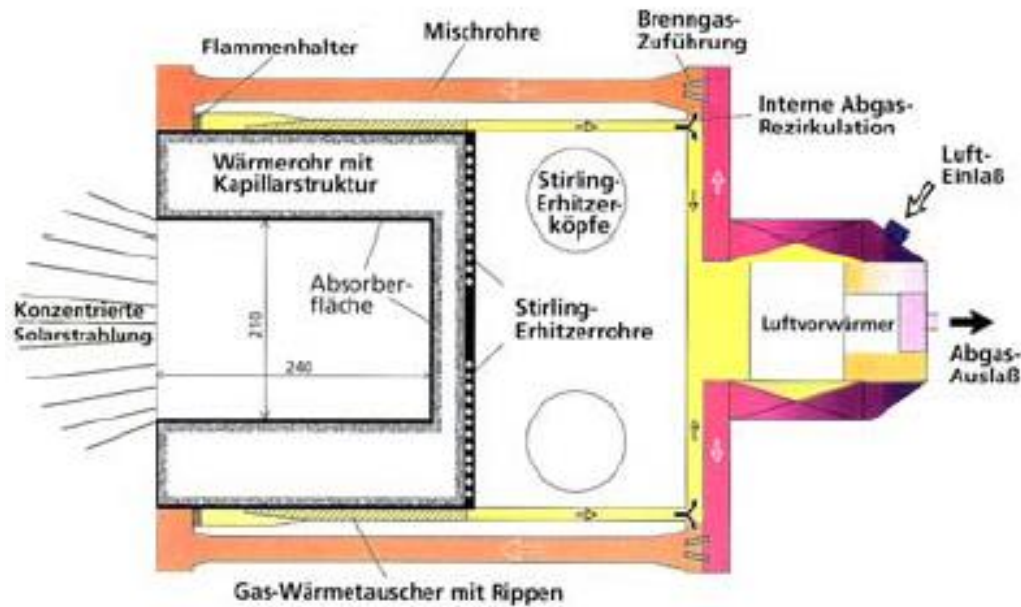
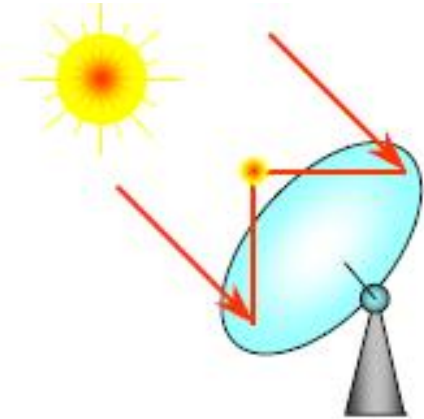

Conversion pathways: Solar to thermal

- Application: CSP e.g. via Stirling cycle

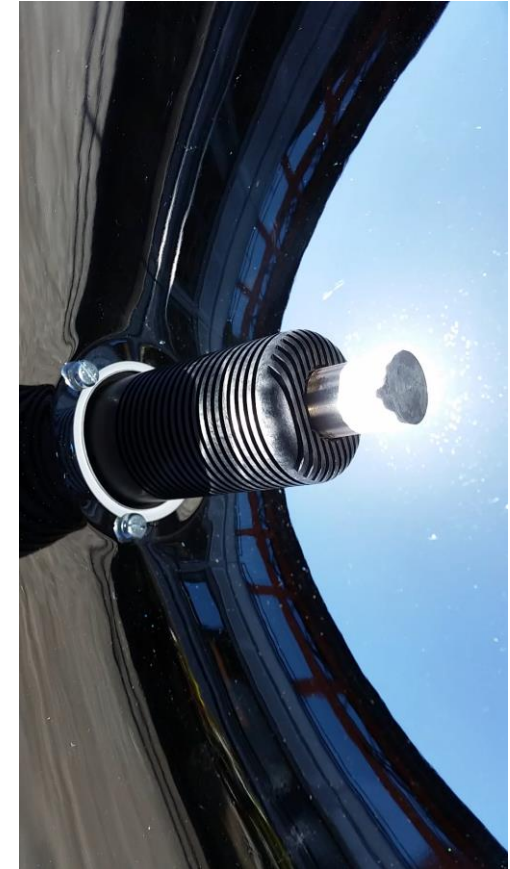
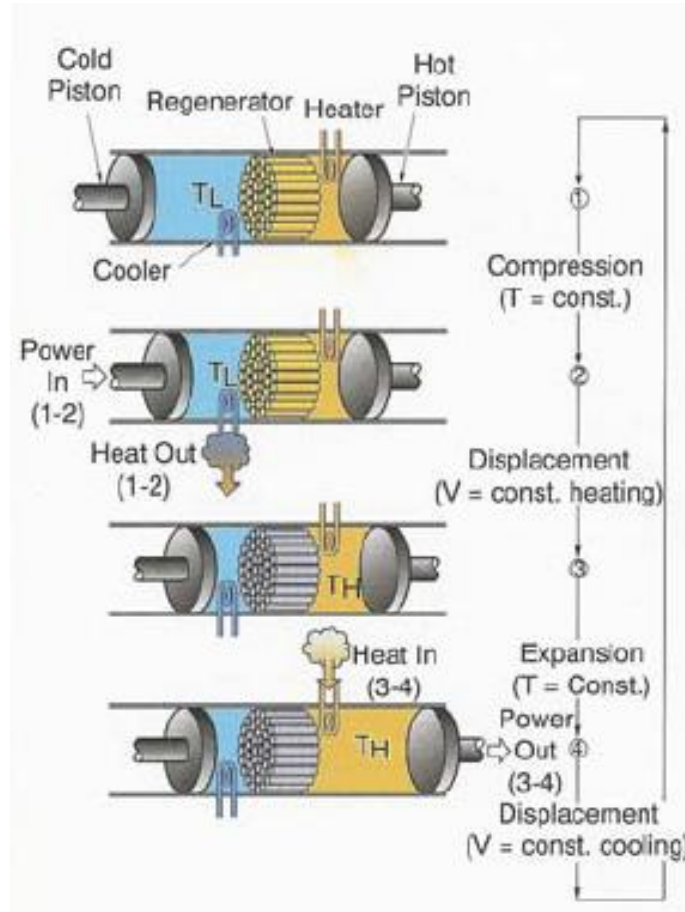
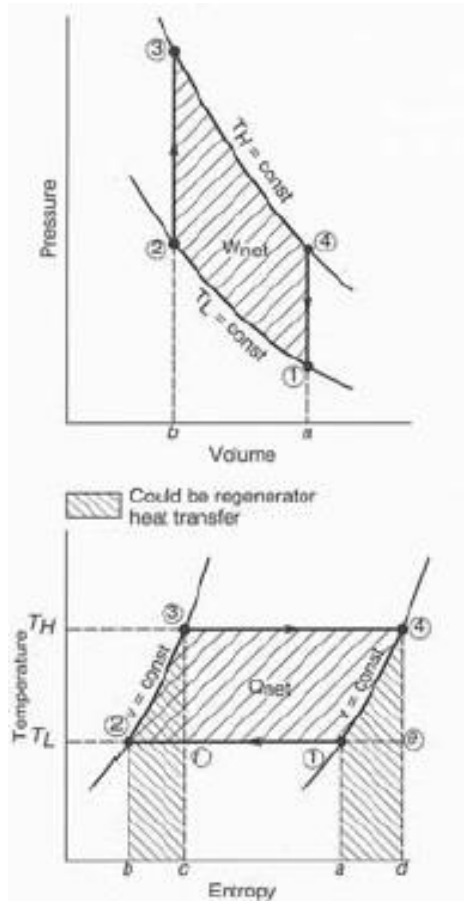

Conversion pathways: Solar to thermal

- Solar to thermal: concentrated radiation, dish

Single-Facet Stretched-Membrane Concentrators

Manufacturer	Schlaich Bergermann und Partner	Schlaich Bergermann und Partner	Solar Kinetics Inc.
Year	1984	1989 / 1997	1990
Aperture Diameter/Area	17 m	7.5 m / 8.5 m	7 m
Concentration Ratio (geometric)	600	4000 / 4000	
Output at 1000 W/m ² insolation	179 kW	36 kW / 45 kW	23.3 kW
Optical Efficiency	79%	82%	67%
Number Built	3	6 and 3	1
http://solstice.crest.org/renewables/dish-stirling/index.html			



Conversion pathways: Solar to thermal

- Solar to thermal: concentrated radiation, dish

Glass-Facet Concentrators

Name	JPL-TBC	Vanguard I	MDAC
Manufacturer	E-Systems	Advanco Corp.	McDonnell Douglas
Year	1979	1984	1984
Aperture Diameter/Area	11 m	10.6 m	10.6 m
Concentration Ratio (geometric)	1500-3000	2700	2793
Output at 1000 W/m ² insolation	82 kW	73.1 kW	70-80 kW
Optical Efficiency	89%	89%	88%
Number Built	2	1	8

<http://solstice.crest.org/renewables/dish-stirling/index.html>



LRESE's solar dish

EPFL

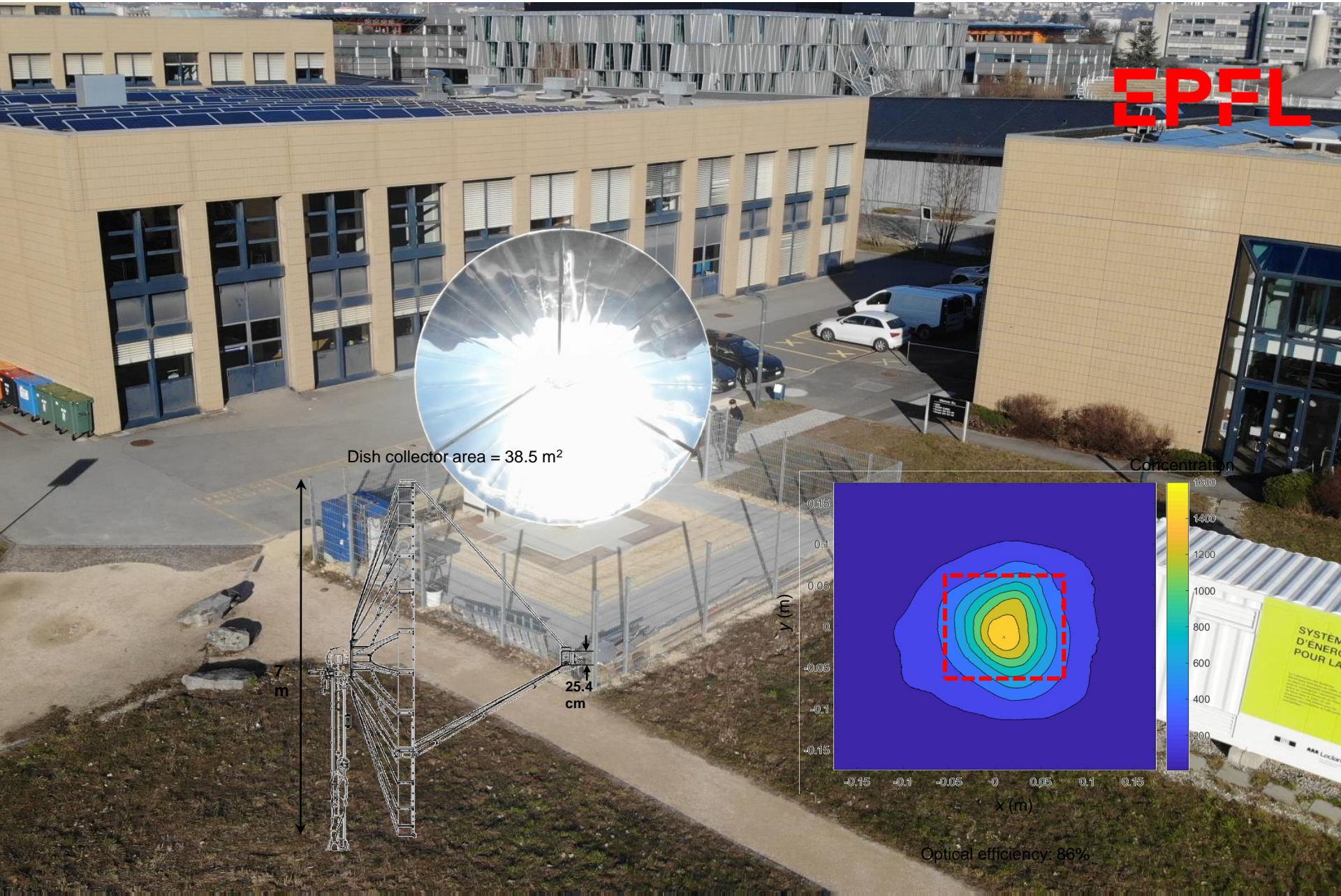

Conversion pathways: Solar to thermal

- Solar to thermal: concentrated radiation
 - Application: concentrated solar power
 - 5.5 GW_{e1} world wide installed capacity in 2018
- Mostly parabolic trough and towers

FIGURE 30. Concentrating Solar Thermal Power Global Capacity, by Country and Region, 2008-2018

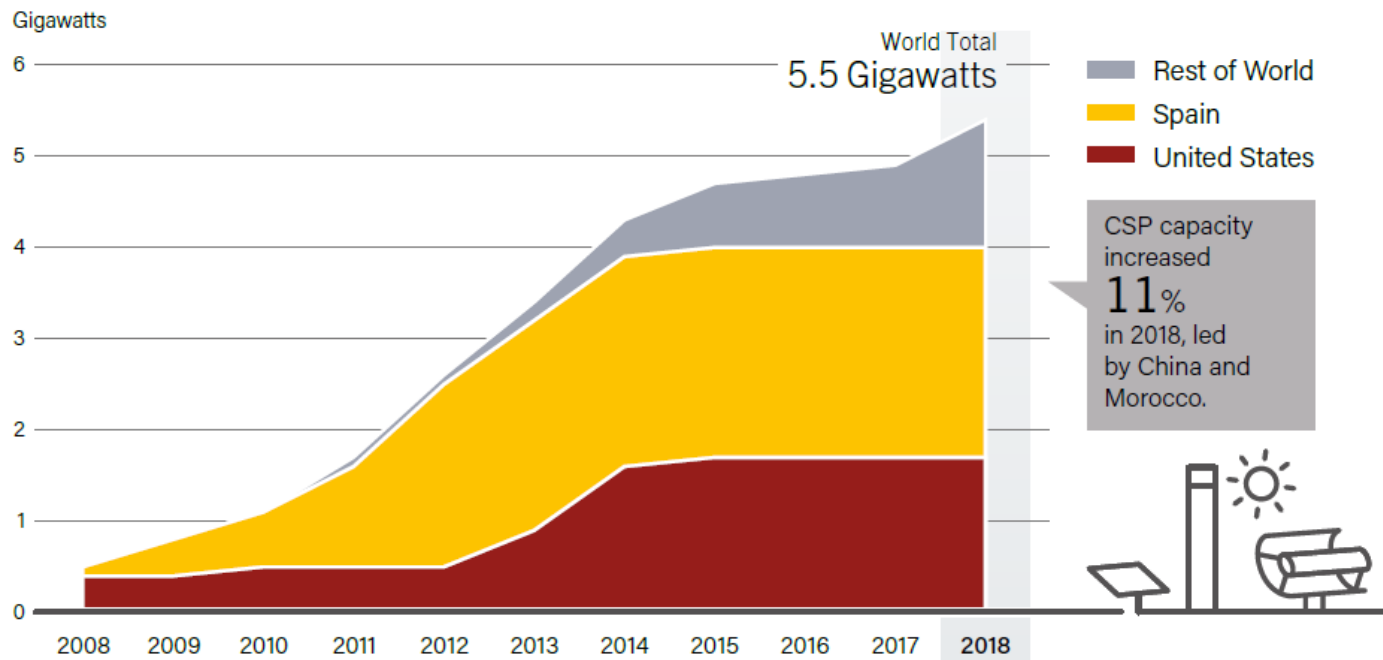

REN21, Renewable 2019 Global Status Report

2015/2016: all installations included thermal energy storage

Conversion pathways: Solar to thermal

- Solar to thermal: concentrated radiation
 - Application: concentrated solar power, land use

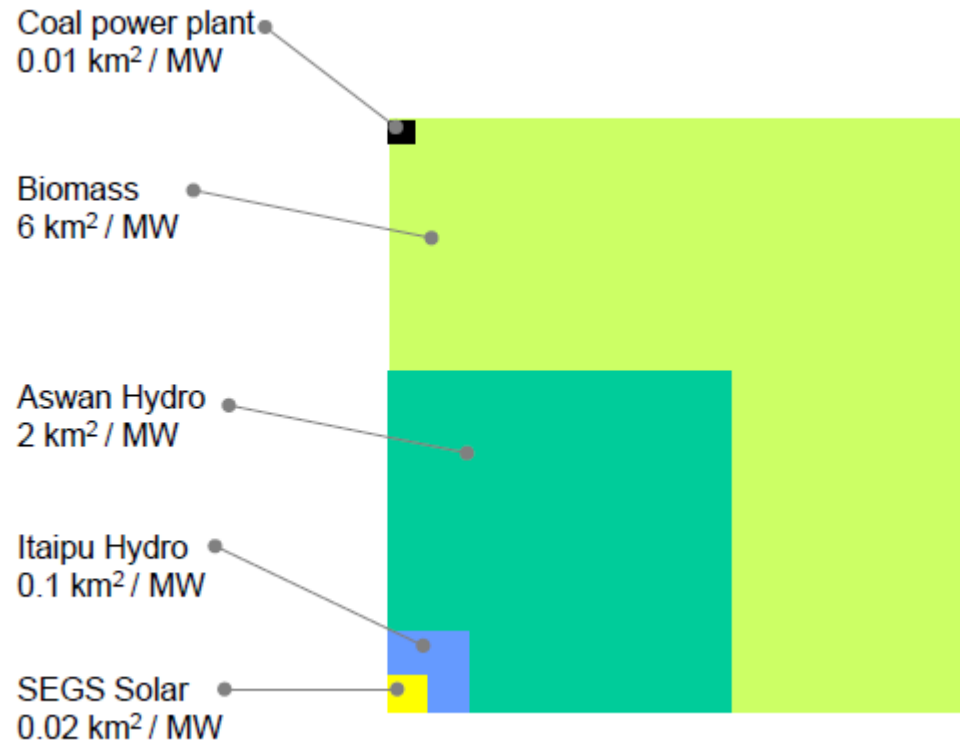

Conversion pathways: Solar to thermal to electrical

- CSP and PV, cost and capacity factor comparison

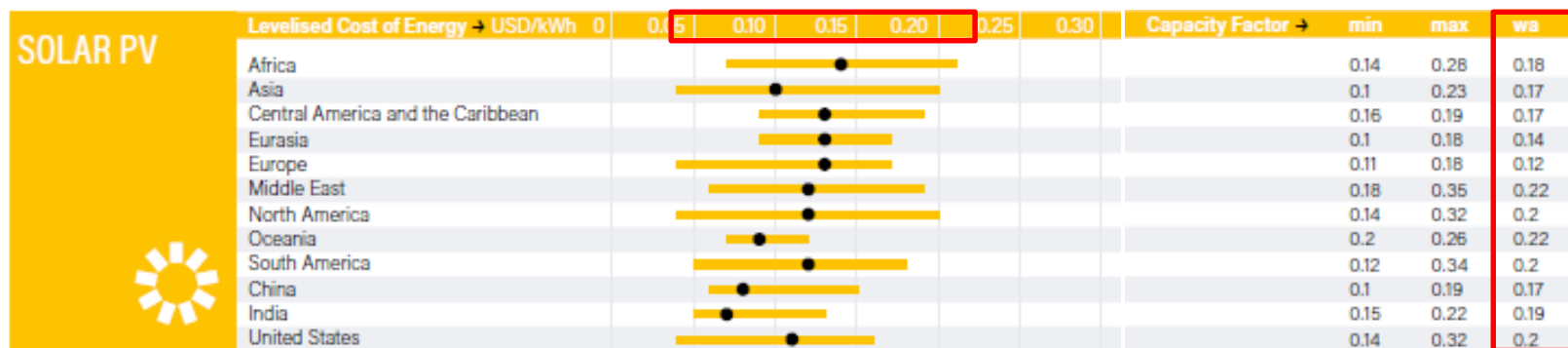

REN21, Renewable 2018 Global Status Report

Conversion pathways: Solar to thermal to electrical

- CSP and PV, learning curve comparison

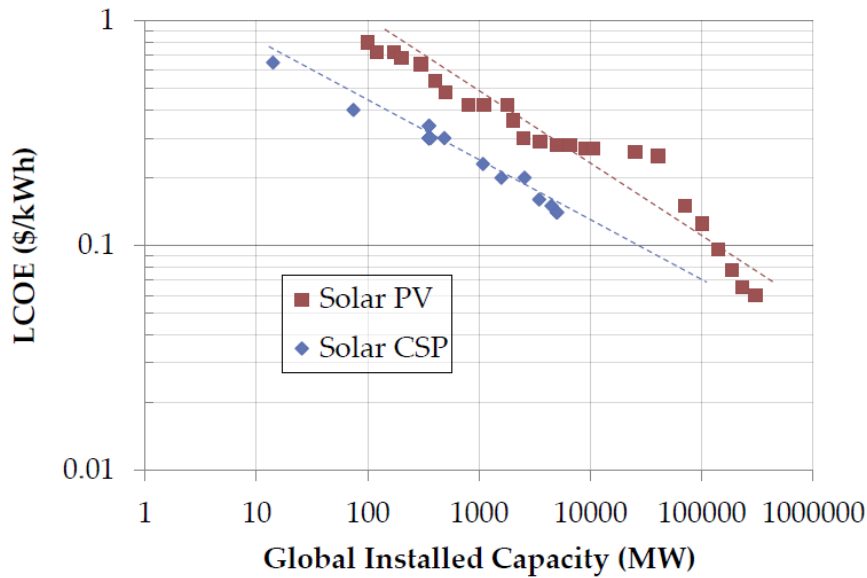

Norwich Technologies, confidential

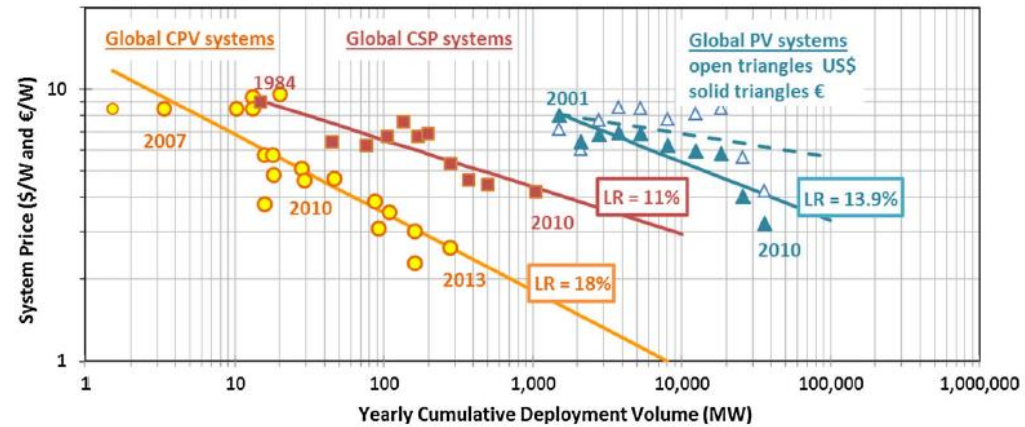

Haysom et al., Progress in Photovoltaics, 2015

Learning outcomes of today's lecture

- Solar energy:
 - Theoretical potential, real potential, exploited potential
 - Characteristics of solar energy / solar irradiation
 - Possible conversion pathways
 - Solar energy for thermal applications (non-concentrated, low temperatures)