

Lecture 8:

The Network Layer

Katerina Argyraki, EPFL

Outline

- **Network-layer functions**
 - ▶ forwarding
 - ▶ routing
- Network-layer types
 - ▶ virtual-circuit networks
 - ▶ datagram networks
- IP forwarding
- IP routing

Forwarding

- **Local** process that takes place at a router and determines output link for each packet
- How: **read** value from packet's network-layer header, **search** forwarding table for output link

Routing

- **Network-wide** process that populates forwarding tables
- How: routing algorithm run on a logically centralised **network controller** or the **routers themselves**

Outline

- Network-layer functions
 - forwarding
 - routing
- Network-layer **types**
 - virtual-circuit networks
 - datagram networks
- IP forwarding
- IP routing

Outline

- Network-layer functions
 - forwarding
 - routing
- Network-layer types
 - virtual-circuit networks
 - datagram networks
- **IP forwarding**
- IP routing

IP forwarding

- Router's forwarding table maps **IP prefixes to output links**
- Reads **destination IP address** from packet's network-layer header
- Performs **longest prefix matching**
 - ▶ finds, in its forwarding table, the IP prefix that matches the dst IP address the best

Outline

- Network-layer functions
 - forwarding
 - routing
- Network-layer types
 - virtual-circuit networks
 - datagram networks
- IP forwarding
- **IP routing**

dest. prefix	output link
52.85.0.0/16	1
8.0.0.0/8	2
12.17.5.0/24	2
...	...

dest. prefix	output link
52.85.0.0/16	3
8.0.0.0/8	1
12.17.5.0/24	2
...	...



dest.	out. link
5.0.0.0/8	3
8.0.0.0/8	2

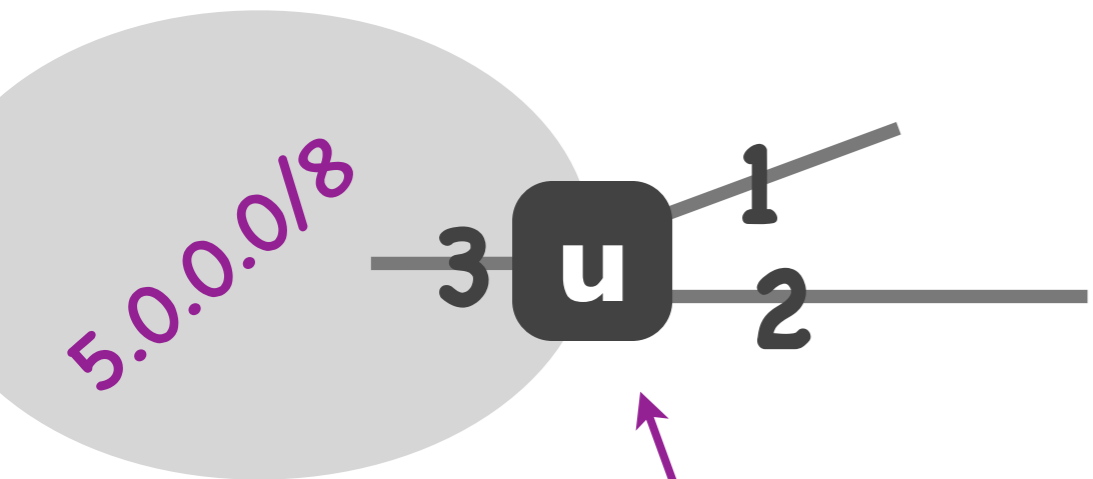

first-hop router for IP subnet 5.0.0.0/8

dest.	out. link
8.0.0.0/8	1
5.0.0.0/8	2

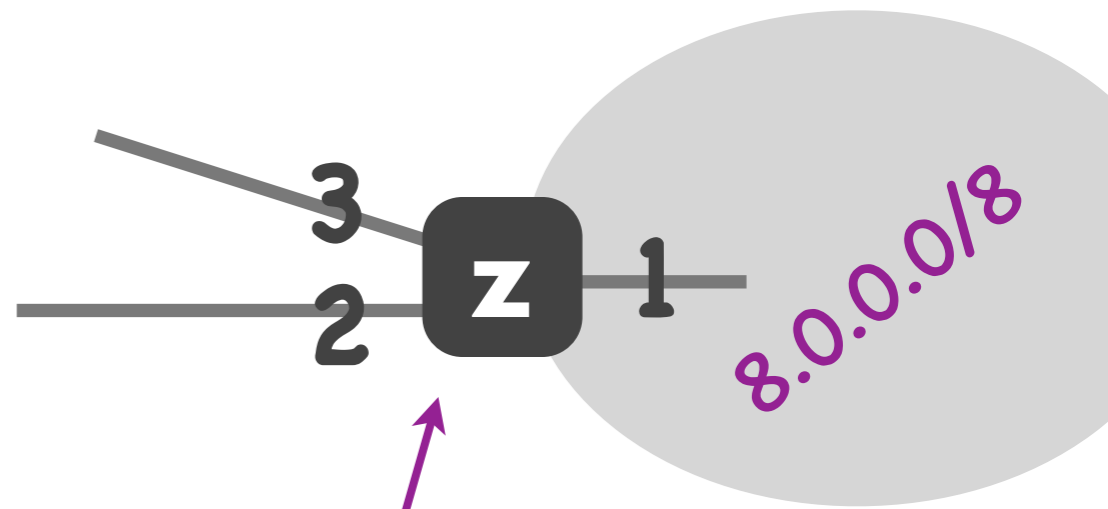

first-hop router for IP subnet 8.0.0.0/8

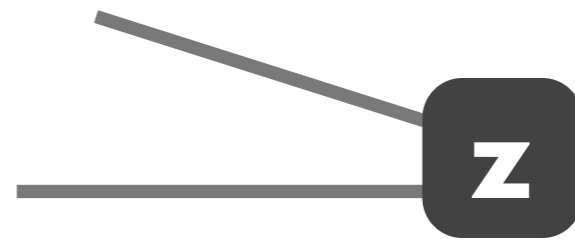
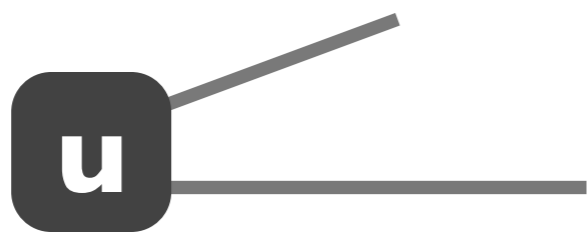

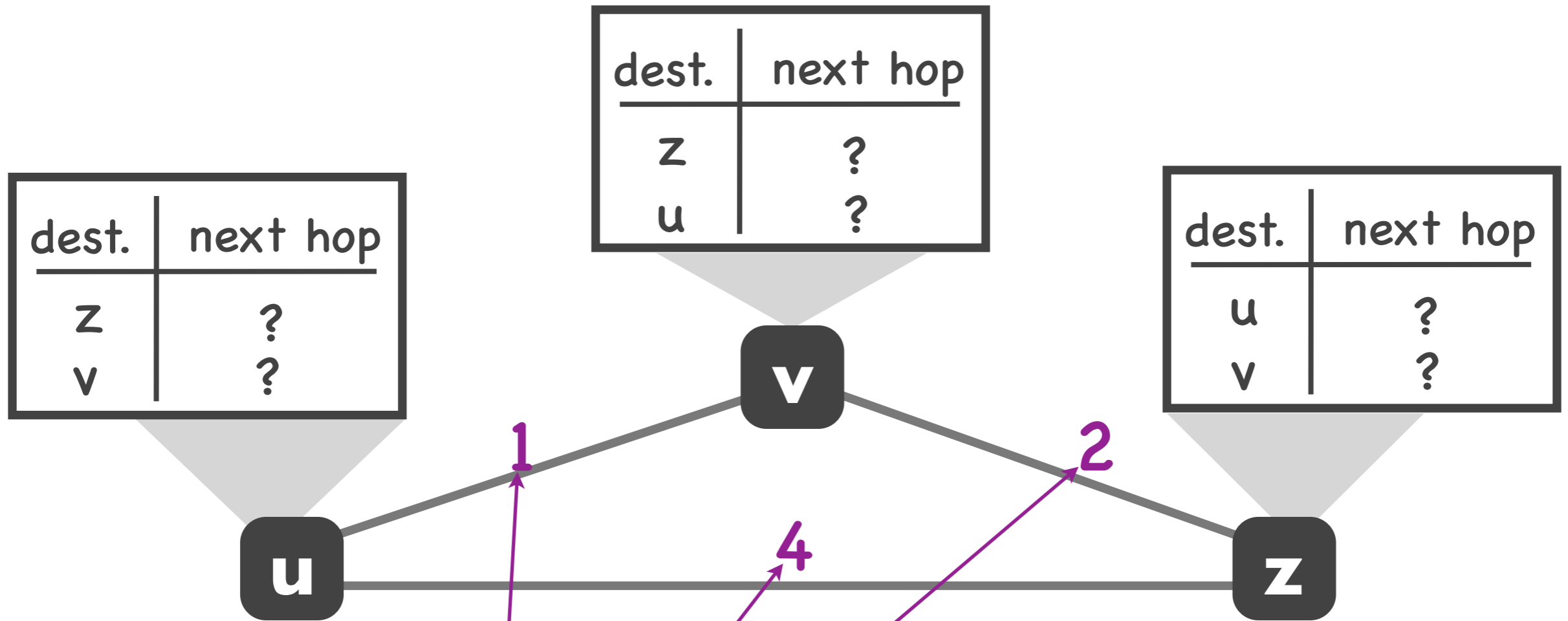

link costs

could represent:
 propagation delay
 usage fee
 ...

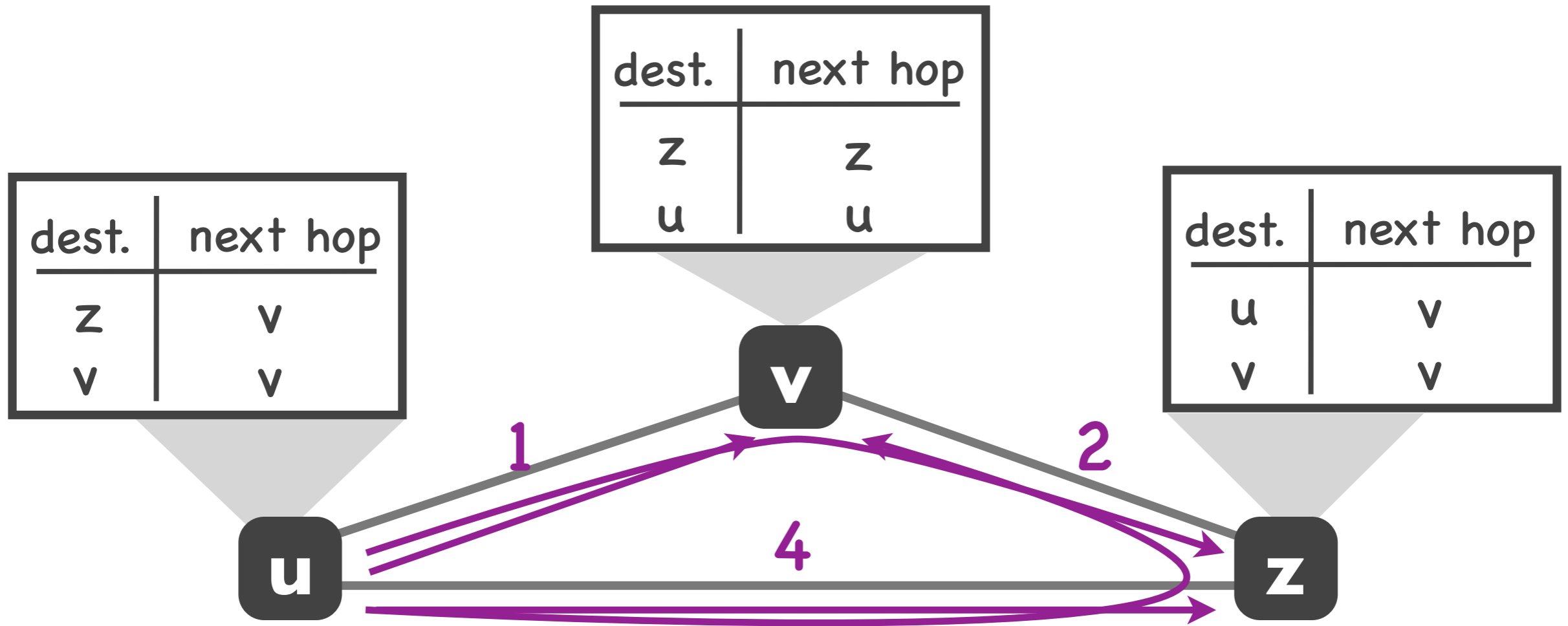

least-cost path from u to z: u v z

least-cost path from u to v: u v

Least-cost path routing

- Goal: find **least-cost path** from each source router to each destination router

dest.	next hop	cost
z		
v		

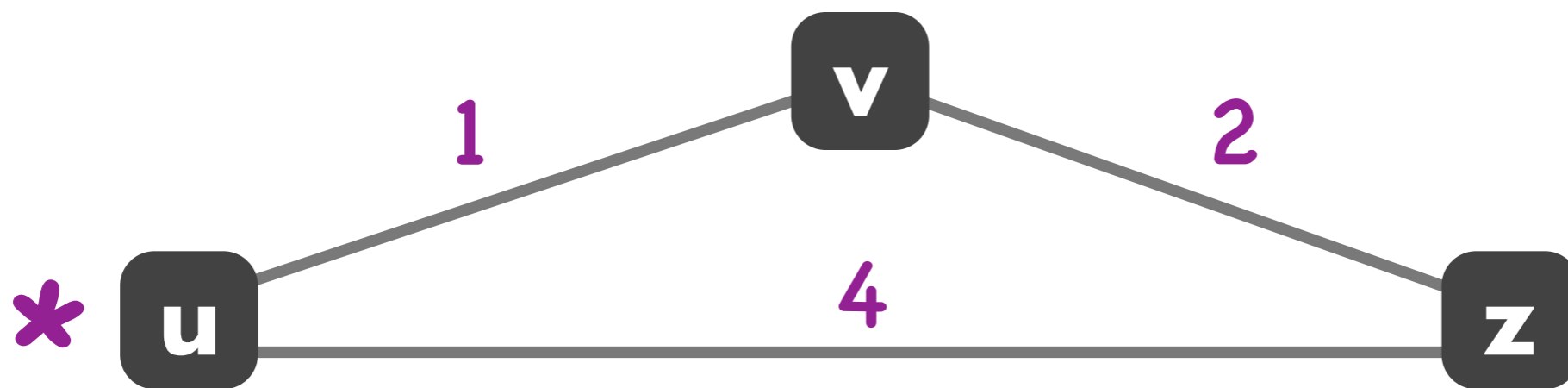

dest.	next hop	cost
z	z	4
v	v	1

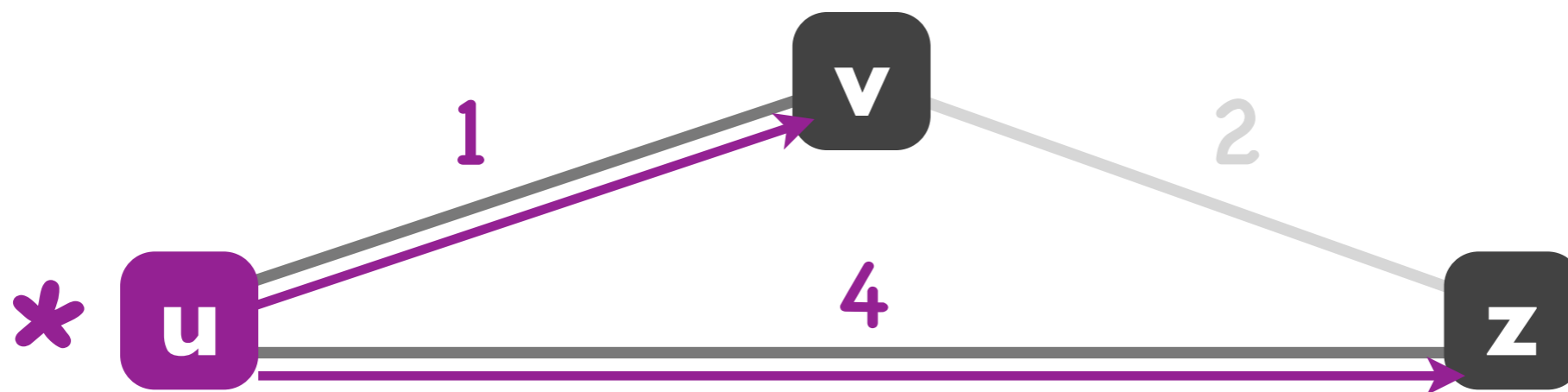

dest.	next hop	cost
z	z v	4 3
v	v	1

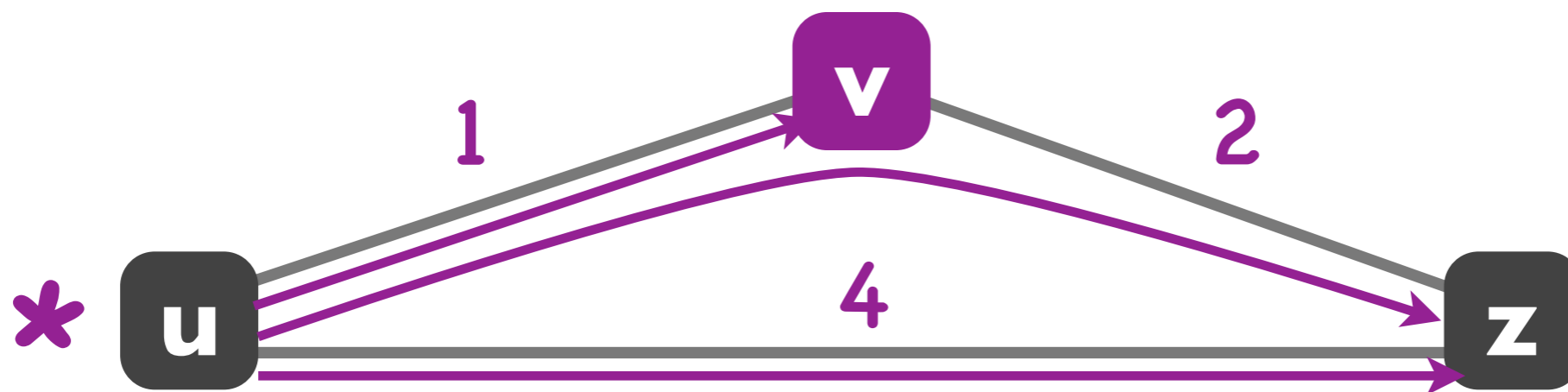

dest.	next hop	cost
z		
v		
x		

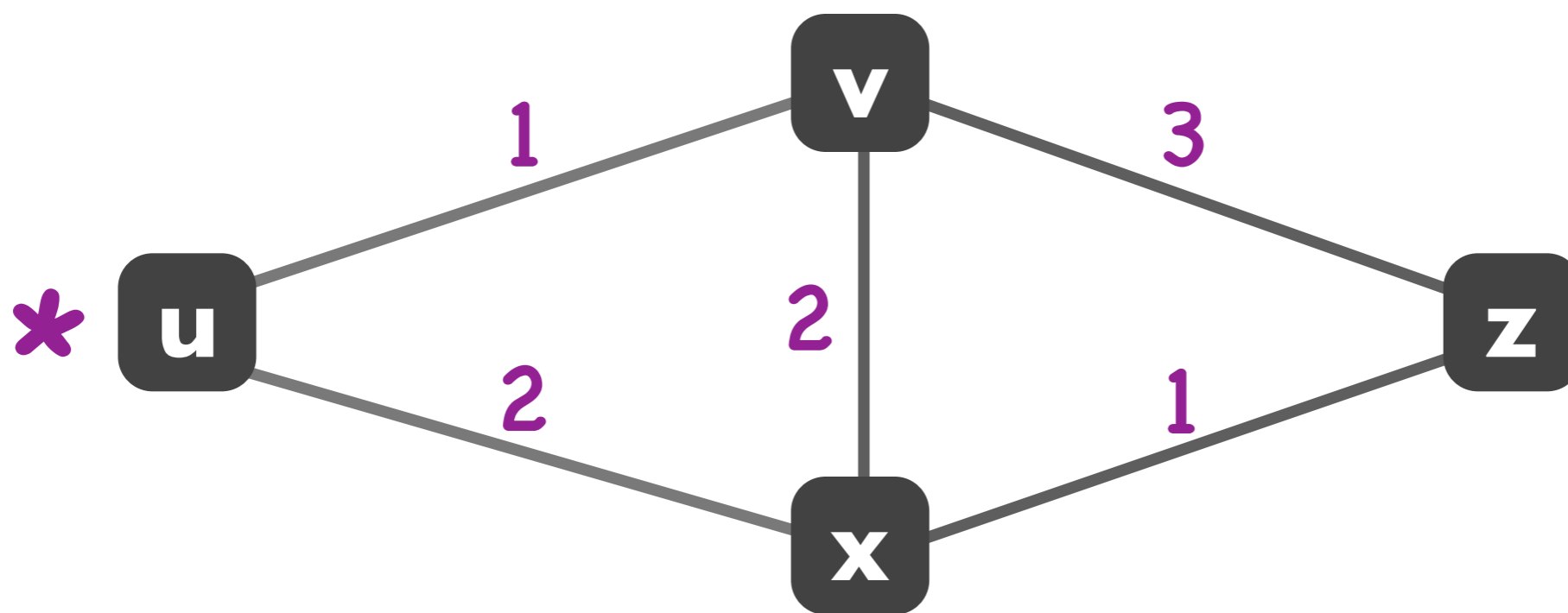

dest.	next hop	cost
z	-	-
v	v	1
x	x	2

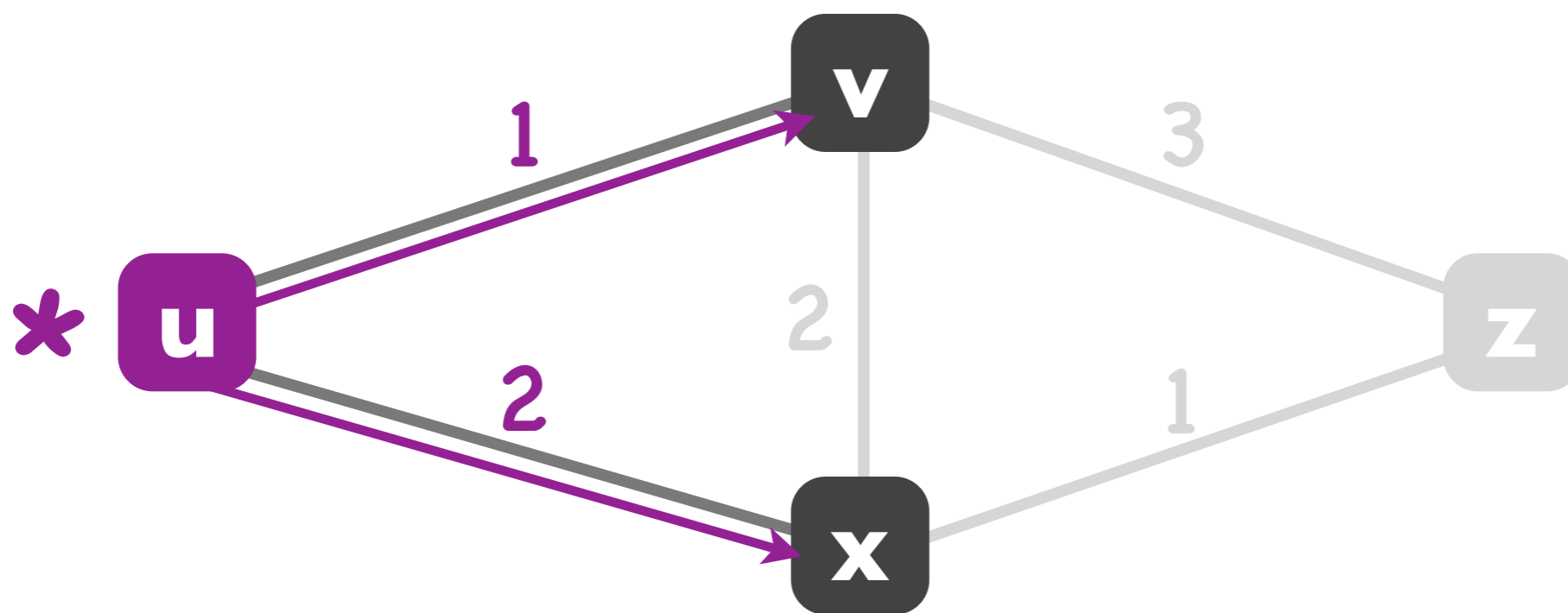

dest.	next hop	cost
z	v	4
v	v	1
x	x	2

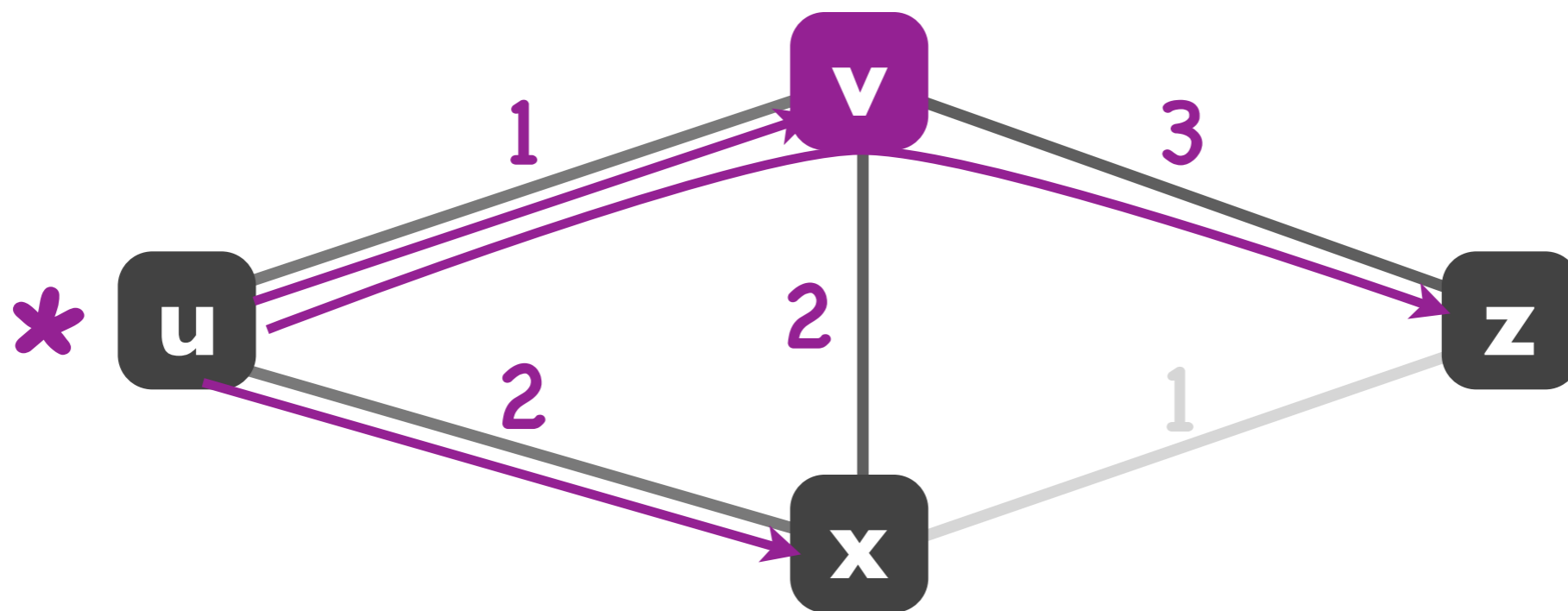

dest.	next hop	cost
z	v x x	1 4 3
v	v	1
x	x	2

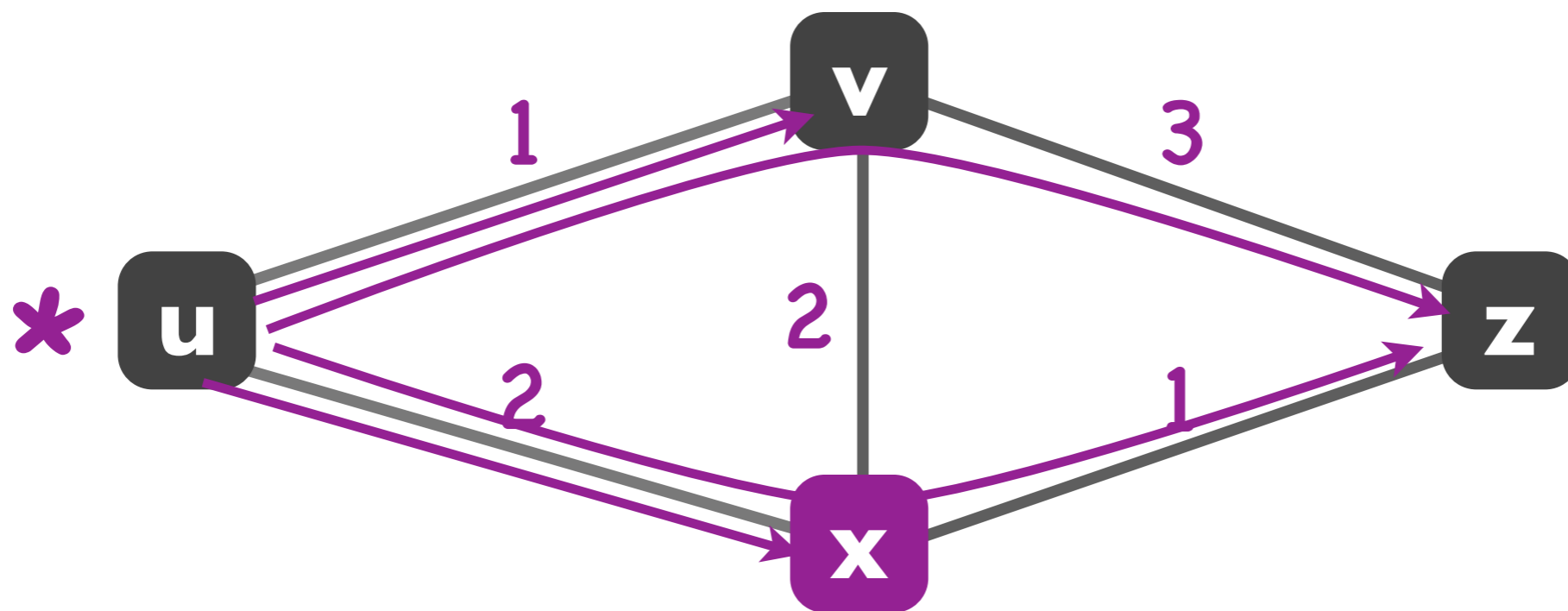

Link-state routing algorithm for source u

- Input: router graph & link costs
- Output: least-cost path from source router u to every other router

Link-state routing algorithm for source u

- “Centralized” algorithm: runs on a single entity
- Option #1: Router u runs the algorithm
- Option #2: Separate computer (“network controller”) runs the algorithm for all the routers

Dijkstra's algorithm

- At each step, consider a new router
 - starting from "closest" neighbor
- Check whether current paths can be improved
 - by using that router as an intermediate point
- End when no improvement is possible

dest.	next hop	cost
z		
w		
y		
v		
x		

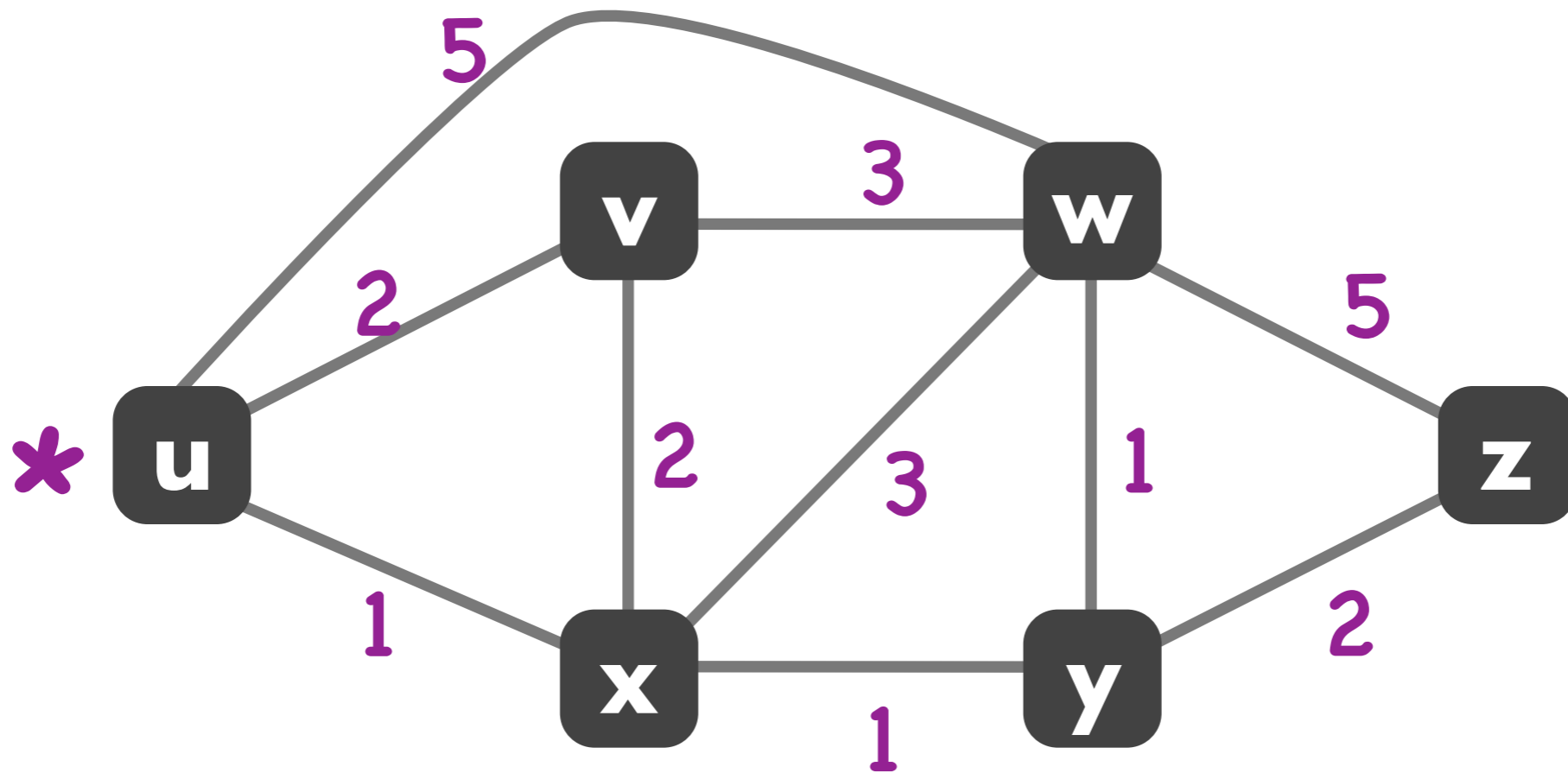

dest.	next hop	cost
z	-	-
w	w	5
y	-	-
v	v	2
x	x	1

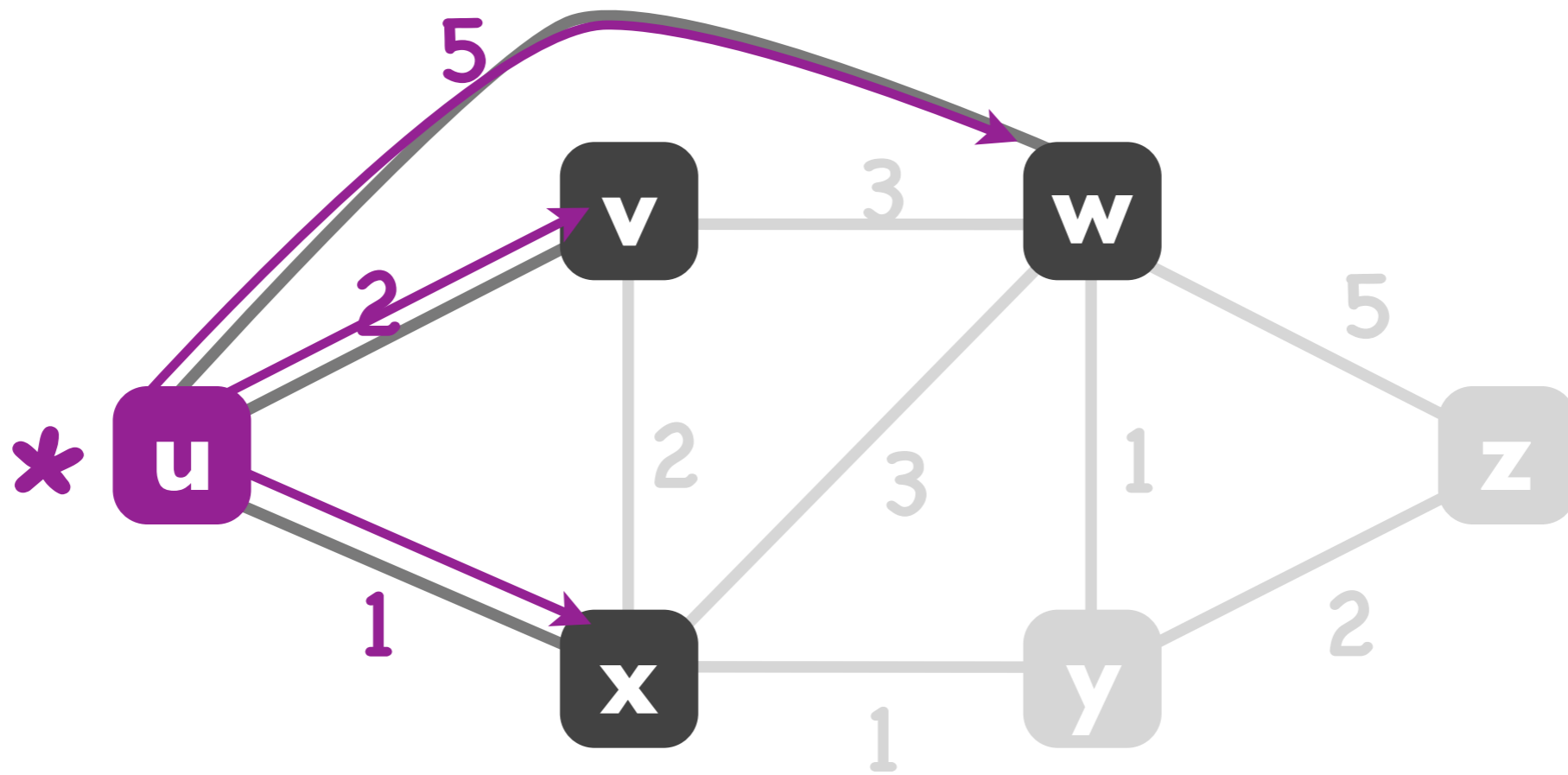

dest.	next hop	cost
z	-	-
w	w x	5 4
y	- x	- 2
v	v	2
x	x	1

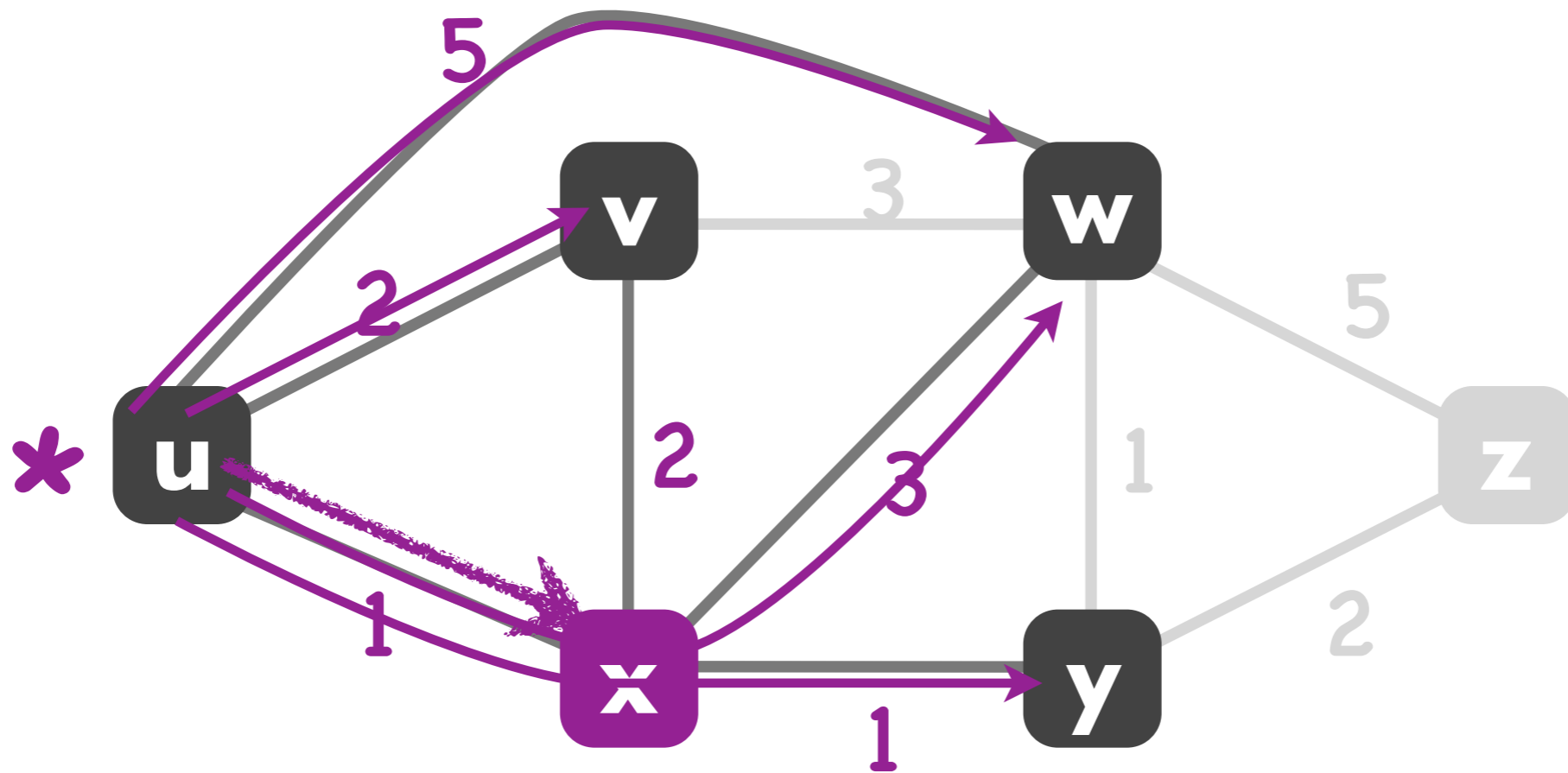

dest.	next hop	cost
z	-	-
w	w x	5 4
y	- x	- 2
v	v	2
x	x	1

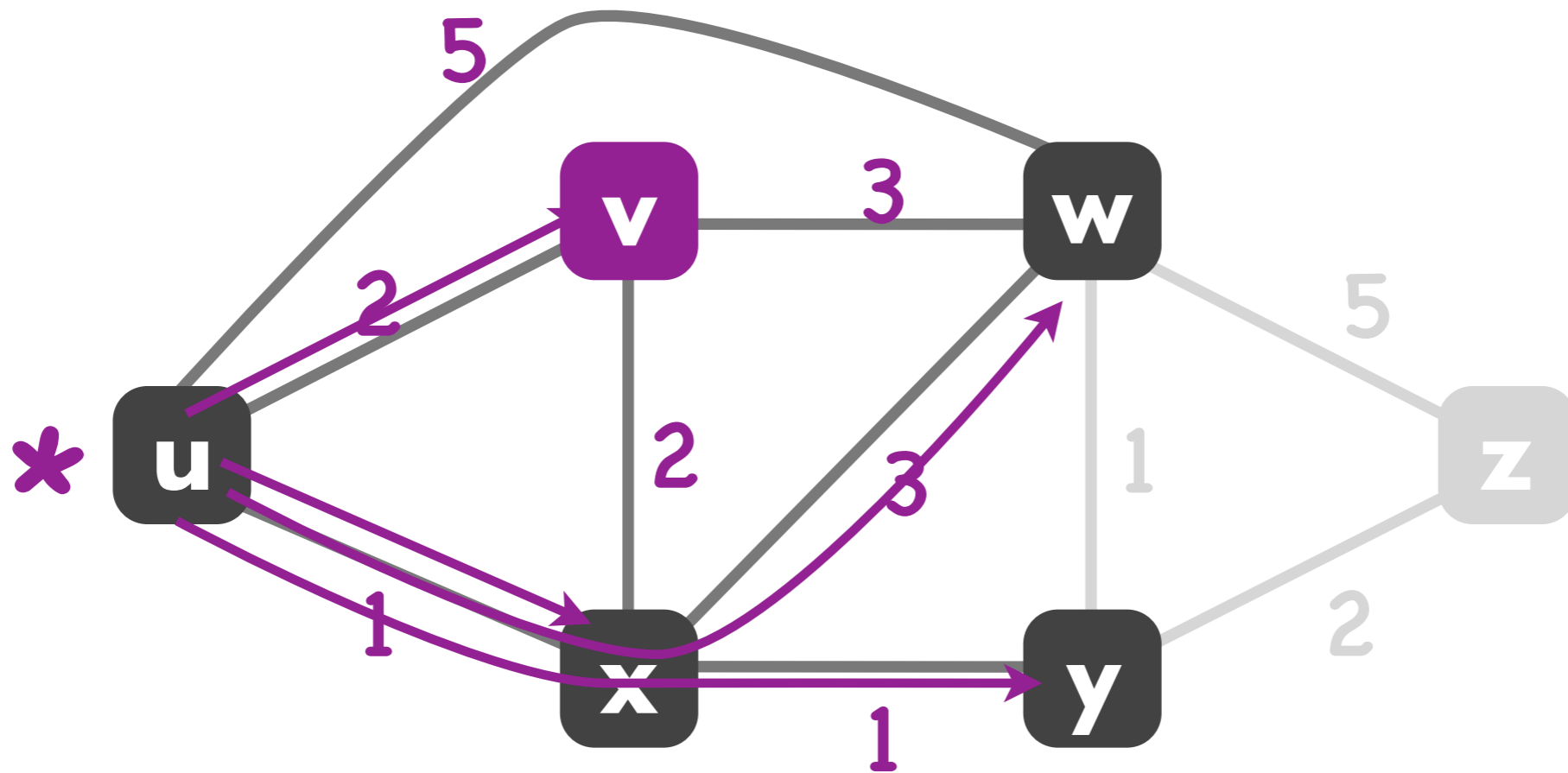

dest.	next hop	cost
z	u x	5 4
w	w x	5 4 3
y	u x	3 2
v	v	2
x	x	1

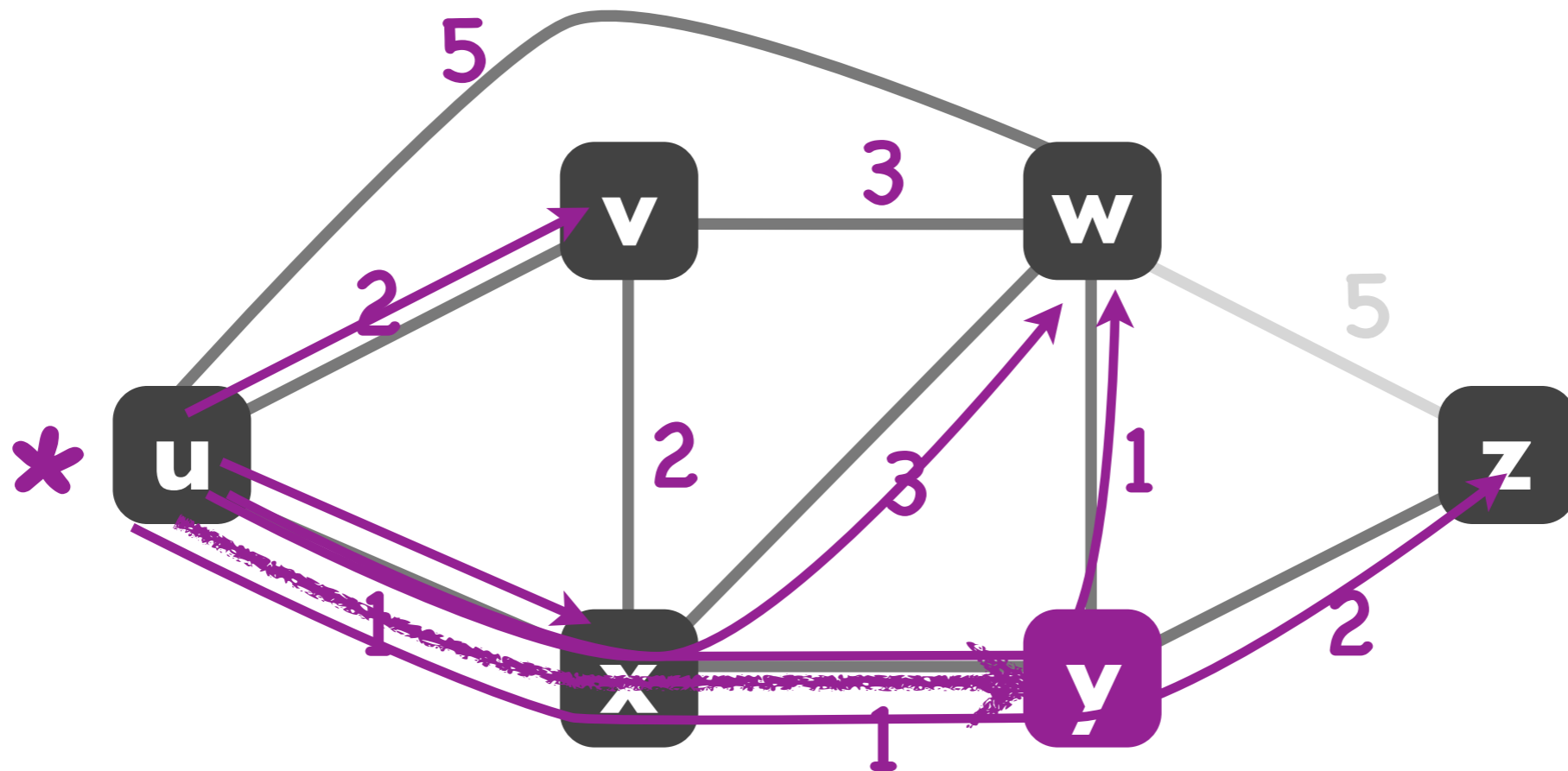

dest.	next hop	cost
z	u x	5 4
w	w x	5 4 3
y	u x	3 2
v	v	2
x	x	1

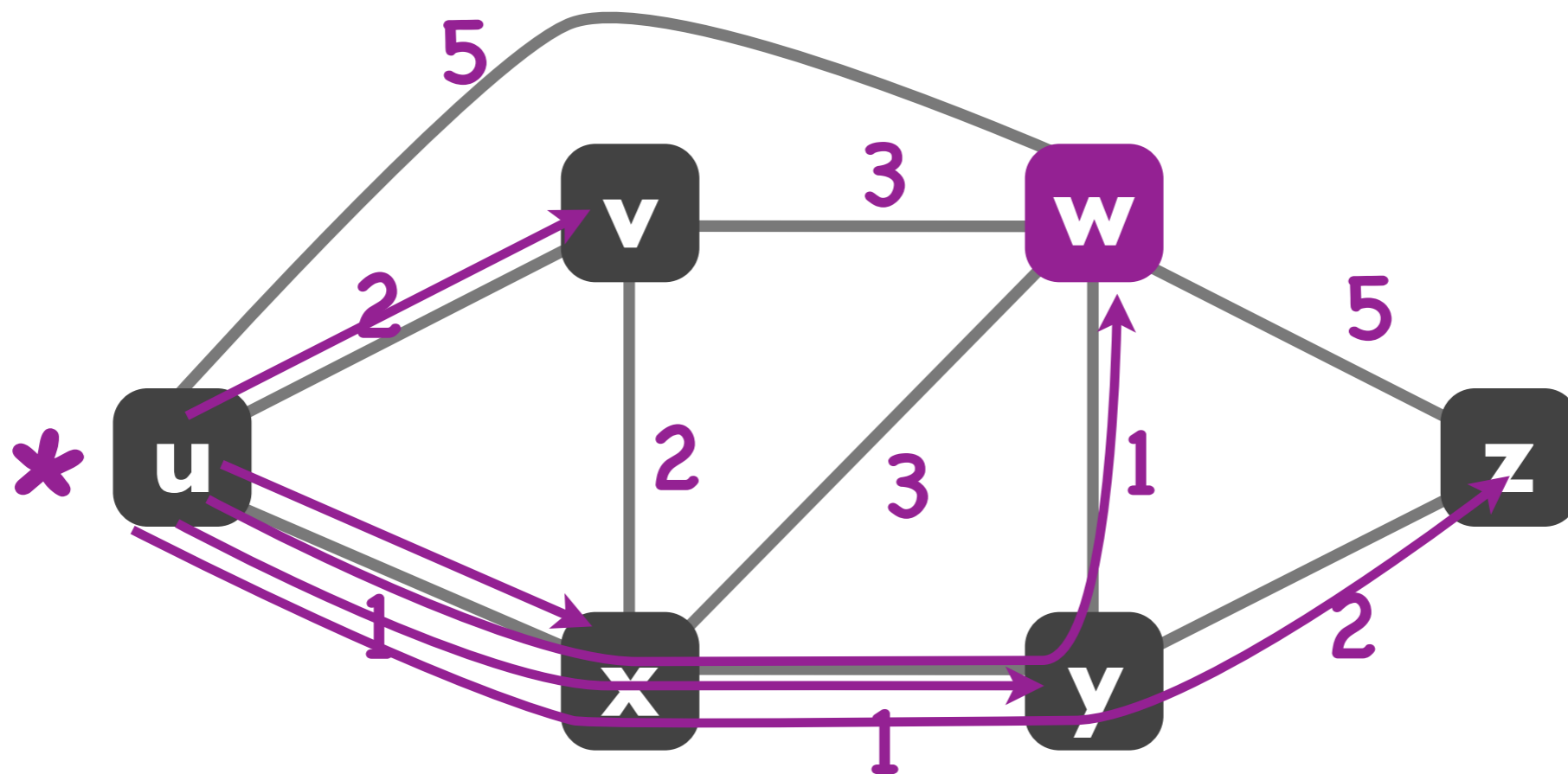

dest.	next hop	cost
z	u x	5 4
w	w x	5 4 3
y	u x	3 2
v	v	2
x	x	1

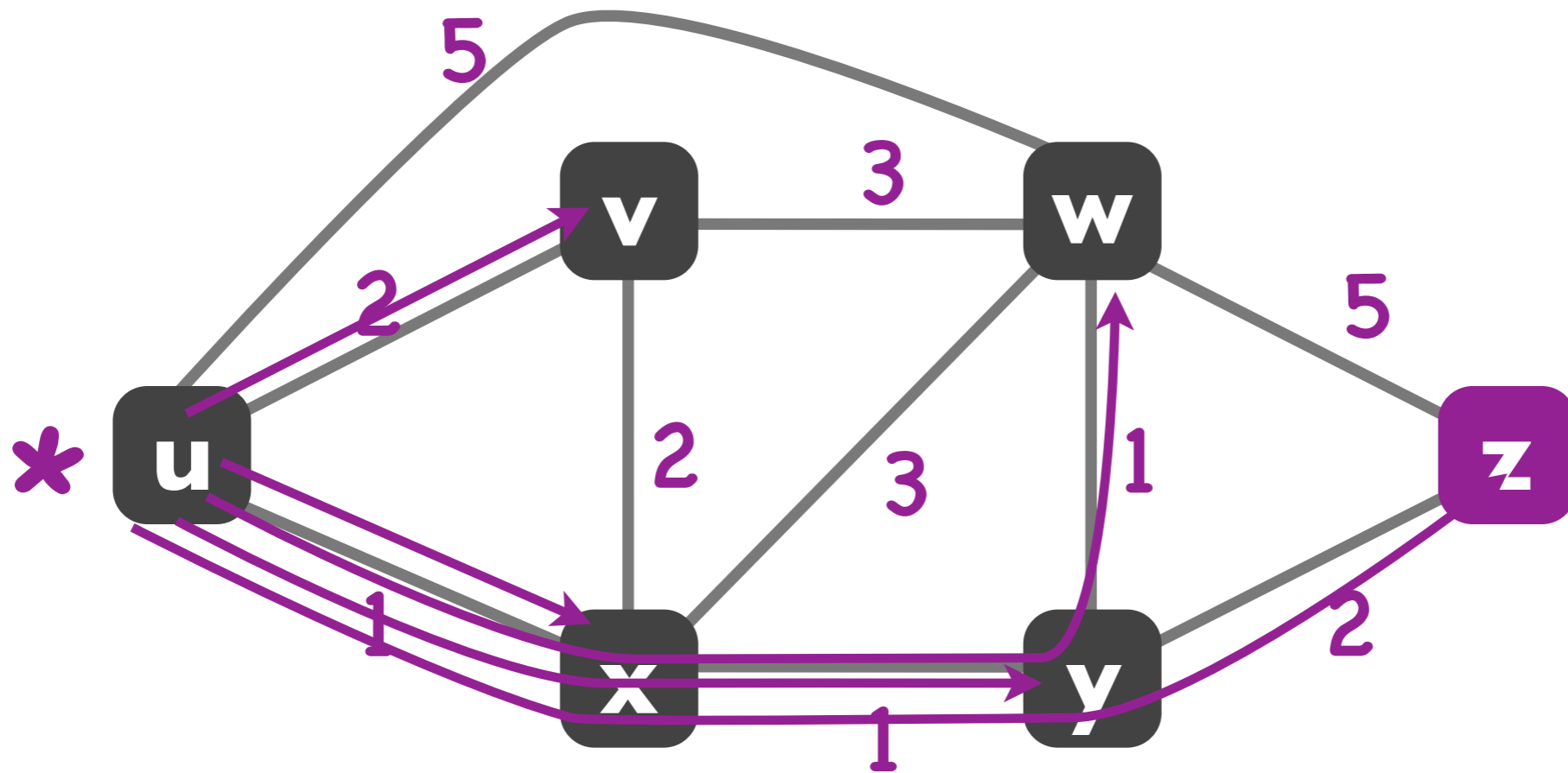

	x	y	z
x	-	-	-
y	2	0	1
z	-	-	-

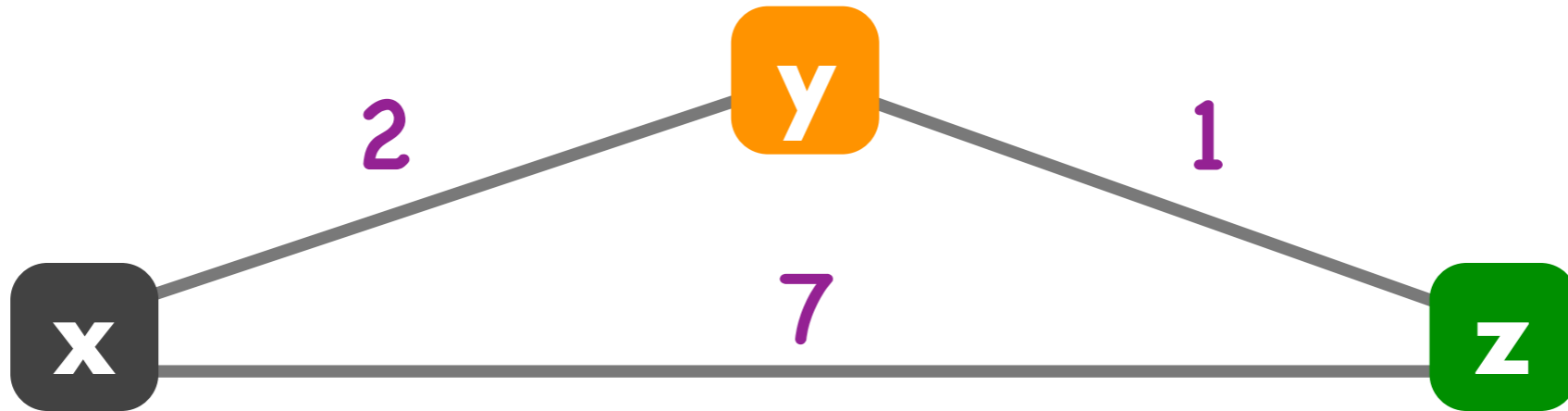

to

from

	x	y	z
x	0	2	7
y	-	-	-
z	-	-	-

	x	y	z
x	-	-	-
y	-	-	-
z	7	1	0

	x	y	z
x	0	2	7
y	2	0	1
z	7	1	0

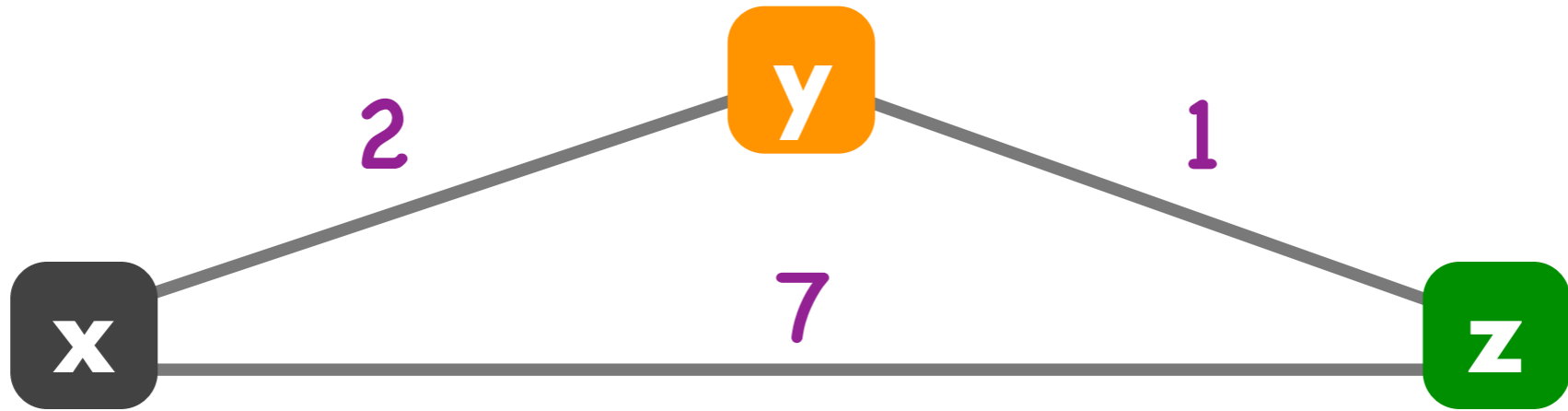

to

from

	x	y	z
x	0	2	7
y			
z			

	x	y	z
x	0	2	7
y	2	0	1
z	7	1	0

	x	y	z
x	0	2	7
y	2	0	1
z	7	1	0

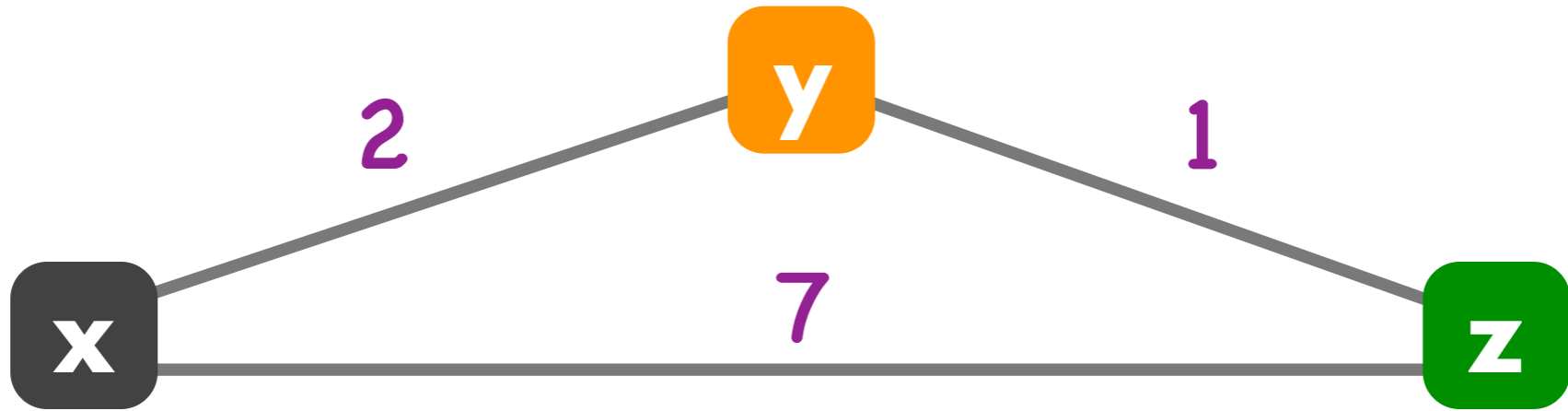

to

from

	x	y	z
x	0	2	3
y	2	0	1
z	7	1	0

	x	y	z
x	0	2	7
y	2	0	1
z	7	1	0

	x	y	z
x	0	2	7
y	2	0	1
z	7	1	0

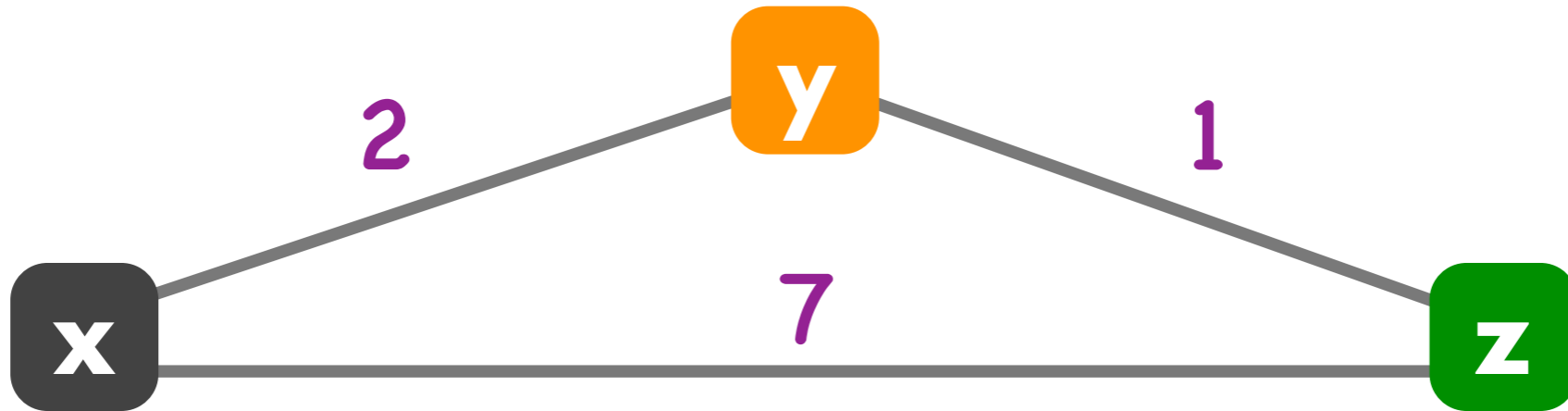

to

from

	x	y	z
x	0	2	3
y	2	0	1
z	7	1	0

	x	y	z
x	0	2	7
y	2	0	1
z	3	1	0

	x	y	z
x	0	2	3
y	2	0	1
z	3	1	0

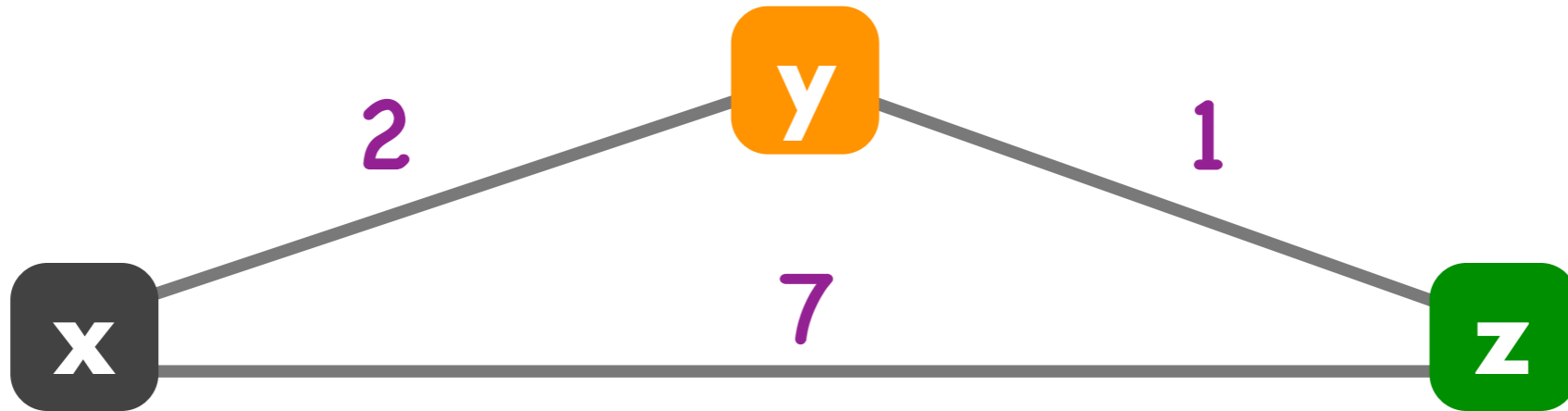

to

from

	x	y	z
x	0	2	3
y	2	0	1
z	3	1	0

	x	y	z
x	0	2	3
y	2	0	1
z	3	1	0

	x	y	v	z
x	-	-	-	-
y	1	0	-	3
z	-	-	-	-

	x	y	v	z
y	-	-	-	-
v	-	-	-	-
z	-	3	1	0

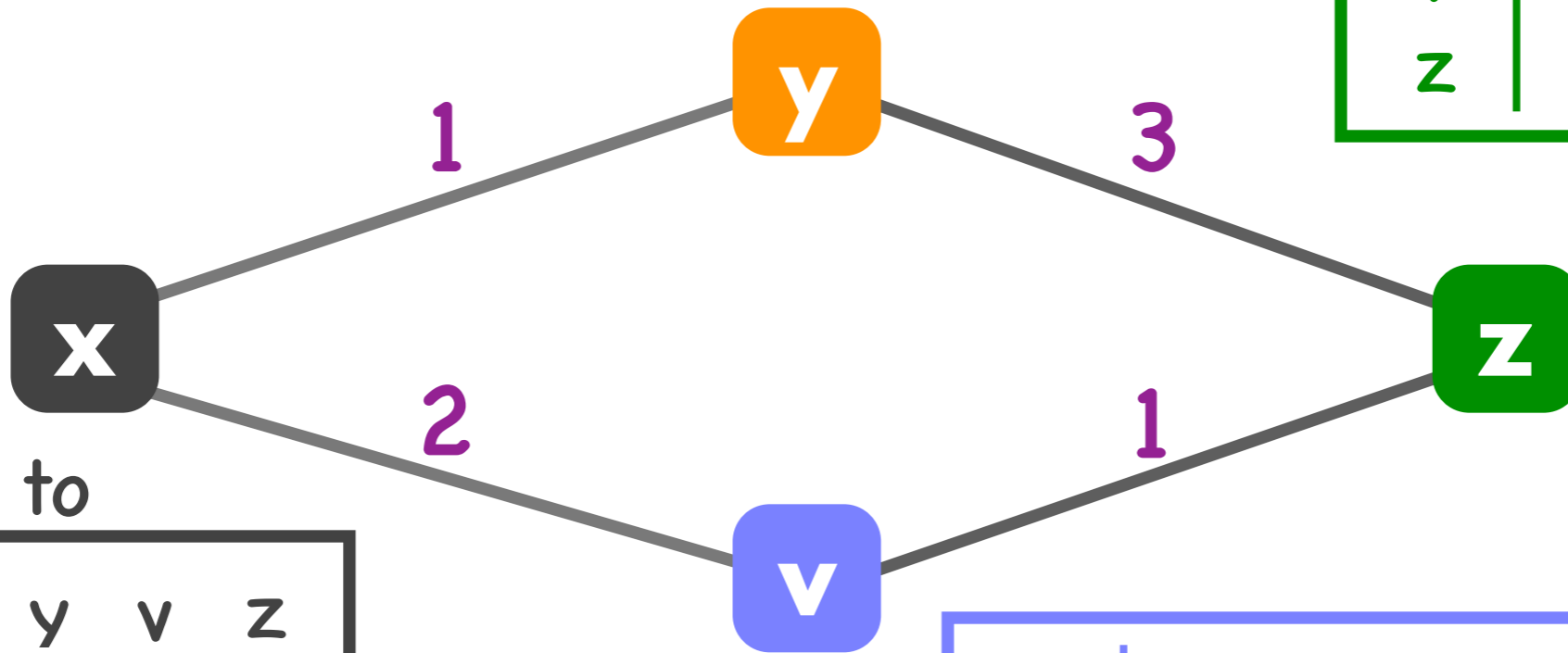

to

	x	y	v	z
x	0	1	2	-
y	-	-	-	-
v	-	-	-	-

	x	y	v	z
x	-	-	-	-
v	2	-	0	1
z	-	-	-	-

from

	x	y	v	z
x	0	1	2	-
y	1	0	-	3
z	-	3	1	0

	x	y	v	z
y	1	0	-	3
v	2	-	0	1
z	-	3	1	0

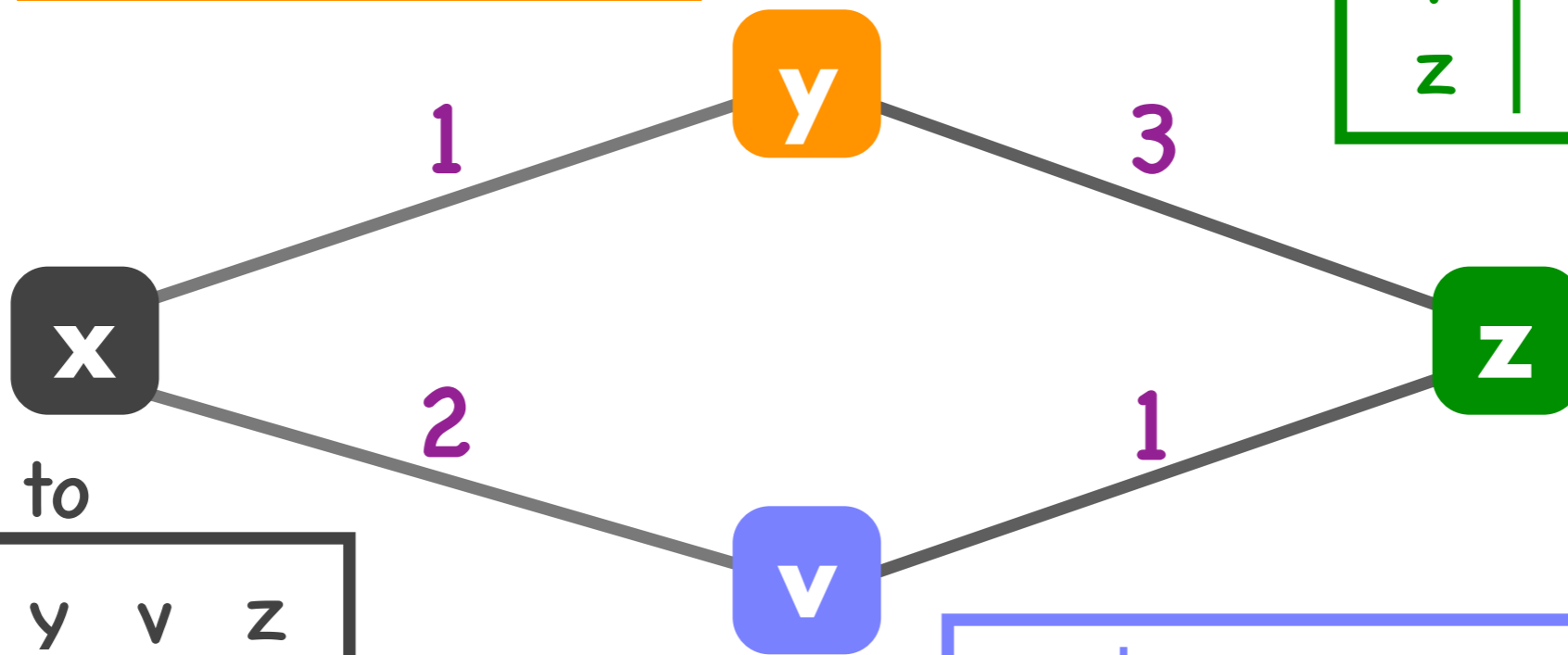

to

from

	x	y	v	z
x	0	1	2	-
y	1	0	-	3
v	2	-	0	1

	x	y	v	z
x	0	1	2	-
v	2	-	0	1
z	-	3	1	0

	x	y	v	z
x	0	1	2	-
y	1	0	-	3
z	-	3	1	0

	x	y	v	z
y	1	0	-	3
v	2	-	0	1
z	-	3	1	0

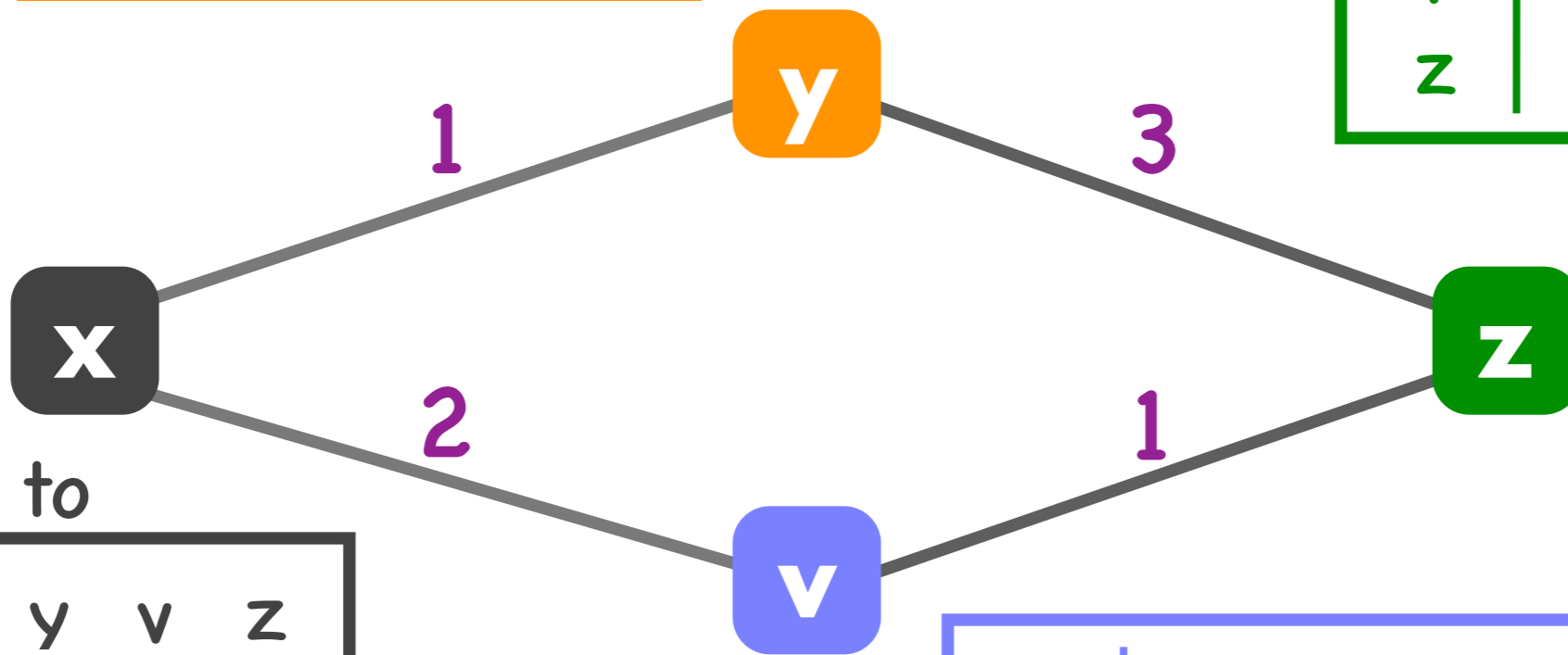

to

	x	y	v	z
x	0	1	2	3
y	1	0	-	3
v	2	-	0	1

	x	y	v	z
x	0	1	2	-
v	2	-	0	1
z	-	3	1	0

from

	x	y	v	z
x	0	1	2	-
y	1	0	-	3
z	-	3	1	0

	x	y	v	z
y	1	0	-	3
v	2	-	0	1
z	3	3	1	0

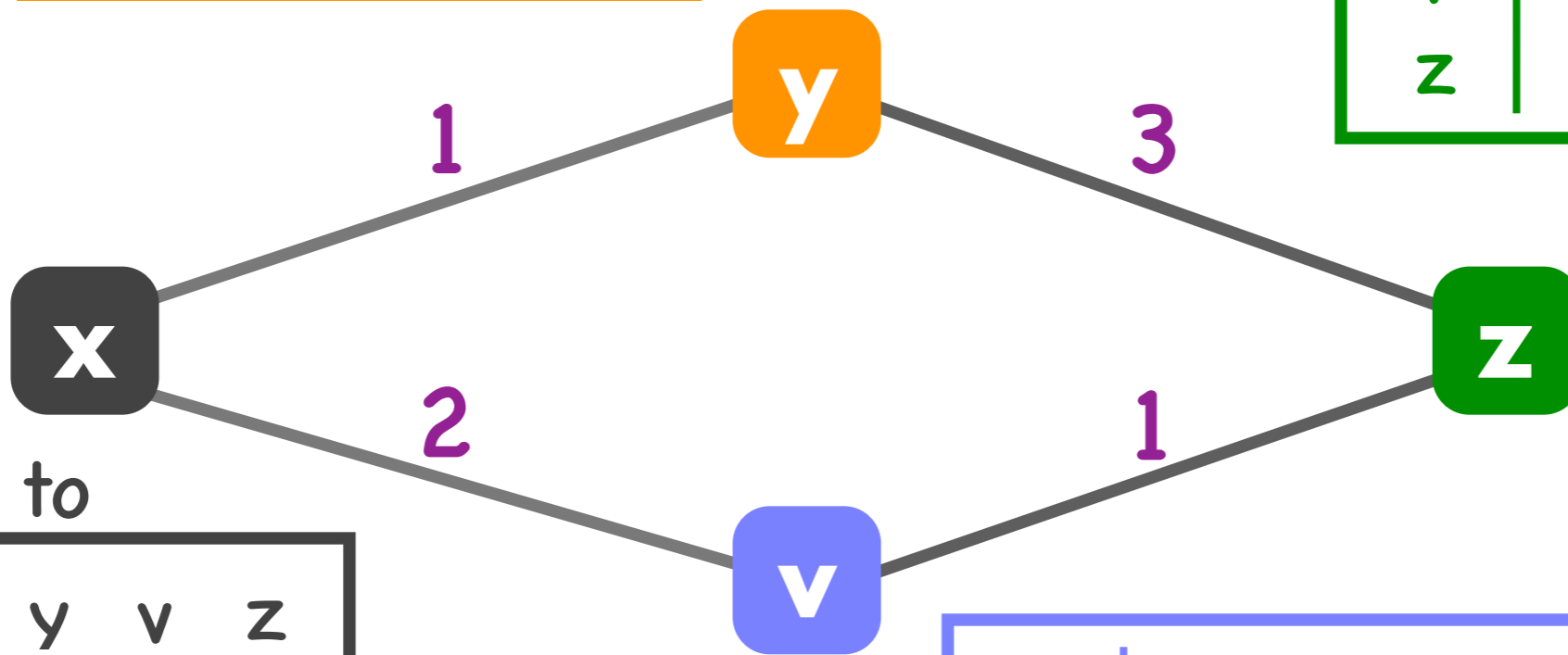

to

	x	y	v	z
x	0	1	2	3
y	1	0	-	3
v	2	-	0	1

	x	y	v	z
x	0	1	2	-
v	2	-	0	1
z	-	3	1	0

from

	x	y	v	z
x	0	1	2	-
y	1	0	3	3
z	-	3	1	0

	x	y	v	z
y	1	0	-	3
v	2	-	0	1
z	3	3	1	0

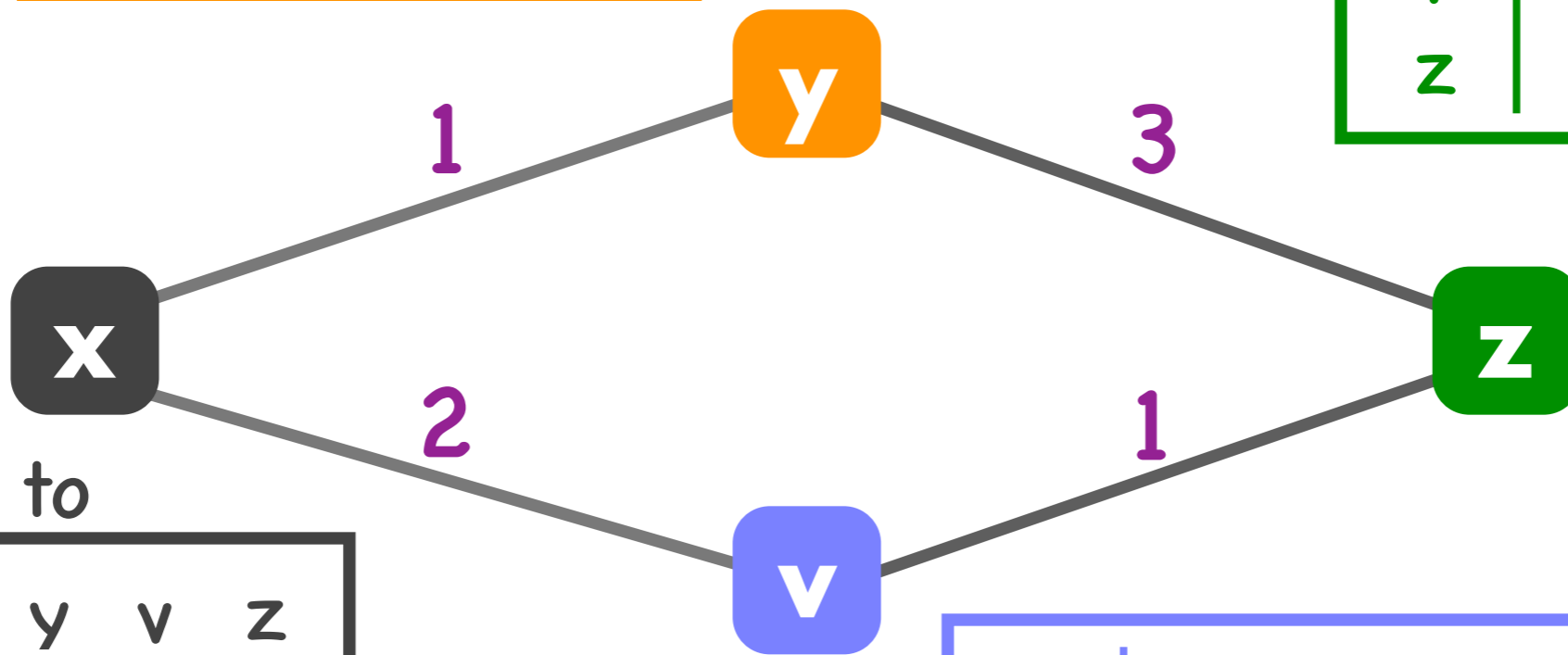

to

	x	y	v	z
x	0	1	2	3
y	1	0	-	3
v	2	-	0	1

	x	y	v	z
x	0	1	2	-
v	2	-	0	1
z	-	3	1	0

from

	x	y	v	z
x	0	1	2	-
y	1	0	3	3
z	-	3	1	0

	x	y	v	z
y	1	0	-	3
v	2	-	0	1
z	3	3	1	0

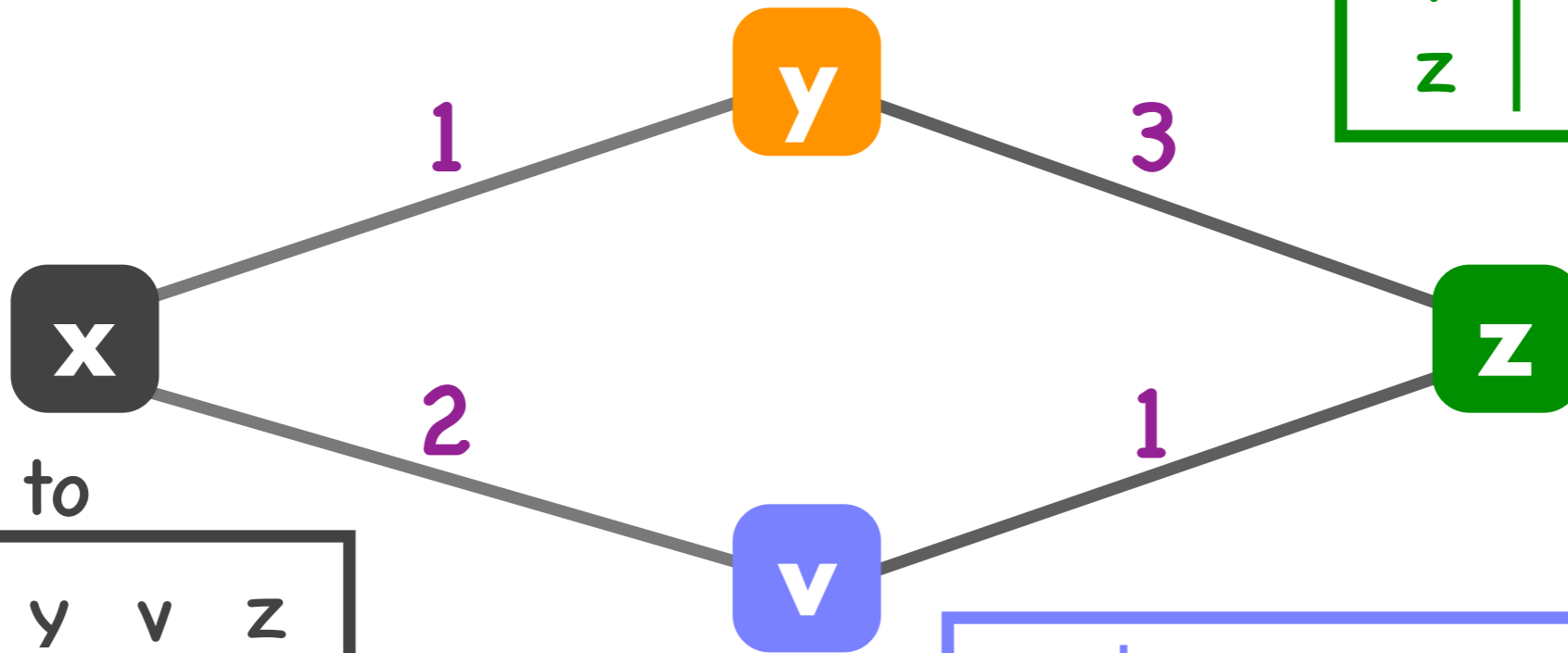

to

	x	y	v	z
x	0	1	2	3
y	1	0	-	3
v	2	-	0	1

	x	y	v	z
x	0	1	2	-
v	2	3	0	1
z	-	3	1	0

from

	x	y	v	z
x	0	1	2	3
y	1	0	3	3
z	3	3	1	0

	x	y	v	z
y	1	0	3	3
v	2	3	0	1
z	3	3	1	0

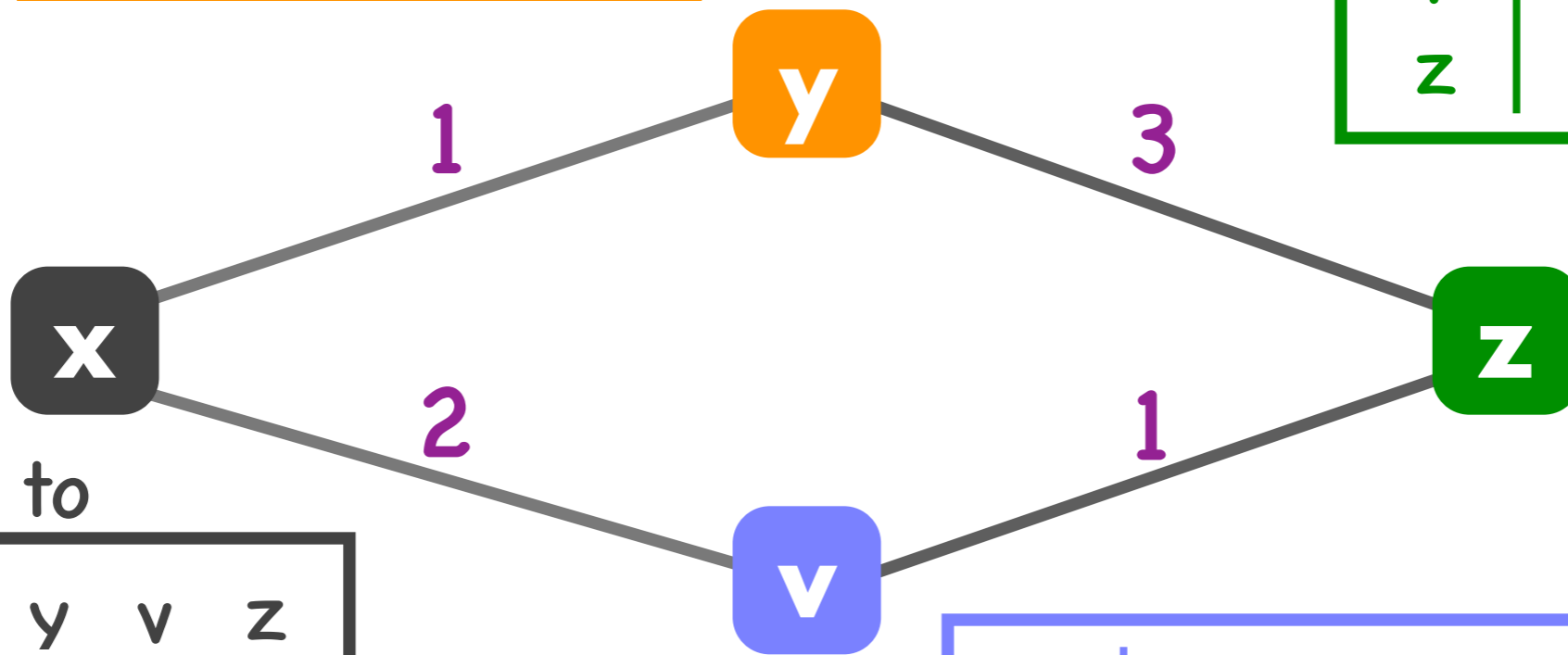

to

	x	y	v	z
x	0	1	2	3
y	1	0	3	3
v	2	3	0	1

	x	y	v	z
x	0	1	2	3
v	2	3	0	1
z	3	3	1	0

from

Distance-vector routing algorithm

- Input to each router: local link costs & neighbor messages
- Output of each router: least-cost path to every other router

Distance-vector routing algorithm

- “Distributed” algorithm
- All routers run it “together”: neighbors exchange and react to each other’s messages

Bellman-Ford algorithm

- All neighbors exchange information
- Each router checks whether it can improve current paths by leveraging the new information
- Ends when no improvement is possible

to

		x	y	z
from	y	2	0	1
z	3	1	0	

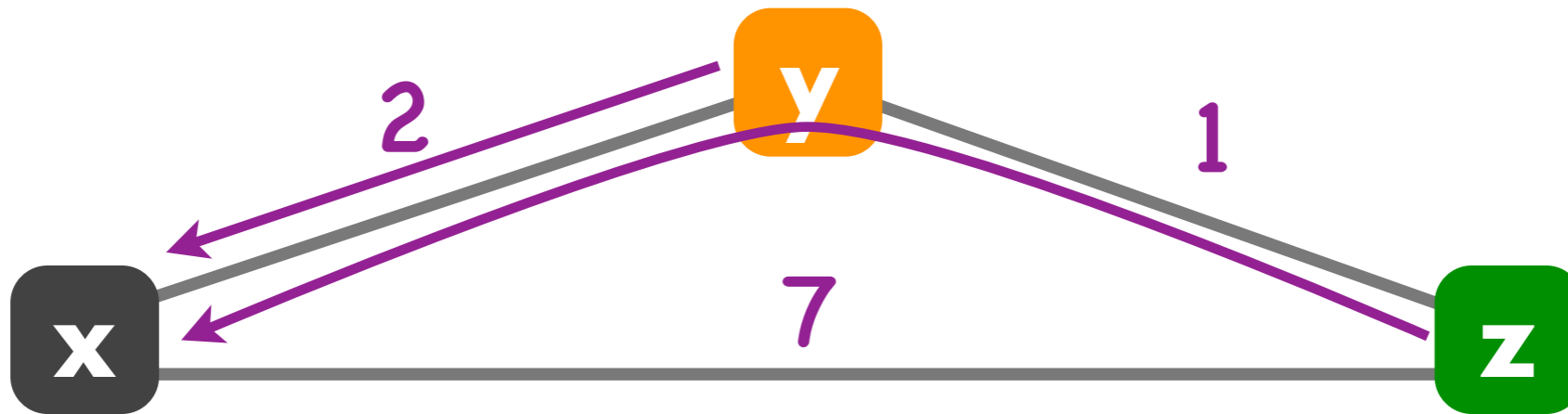

to

		x	y	z
from	y	2	0	1
z	3	1	0	

to

		x	y	z
from				
y		4	0	1
z		3	1	0

routing loop!

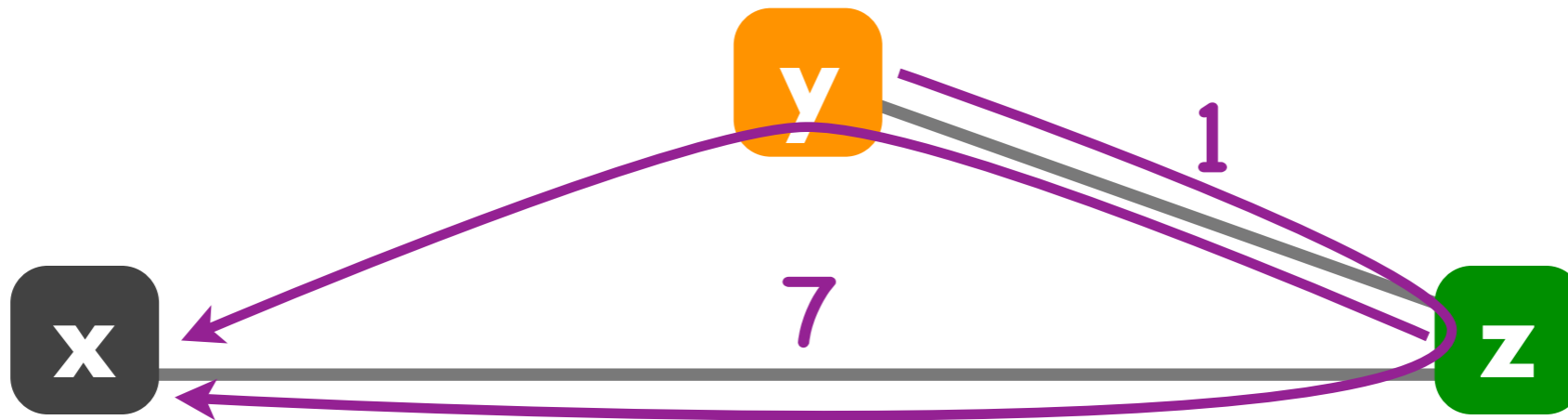

to

		x	y	z
from				
y		2	0	1
z		3	1	0

to

		x	y	z
from				
y		4	0	1
z		3	1	0

routing loop!

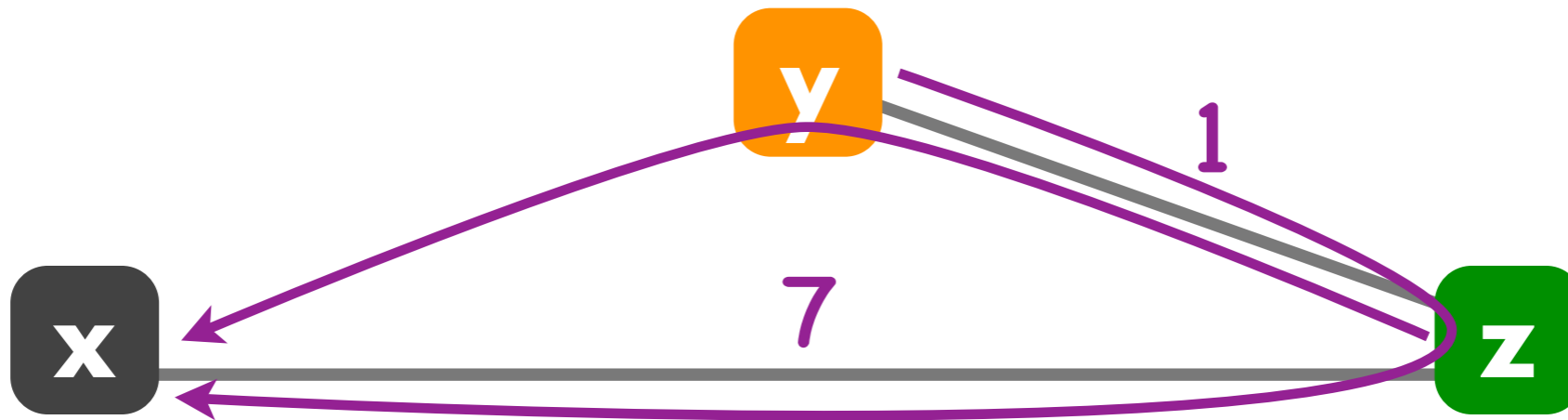

to

		x	y	z
from				
y		4	0	1
z		3	1	0

to

		x	y	z
from				
y		4	0	1
z		3	1	0

routing loop!

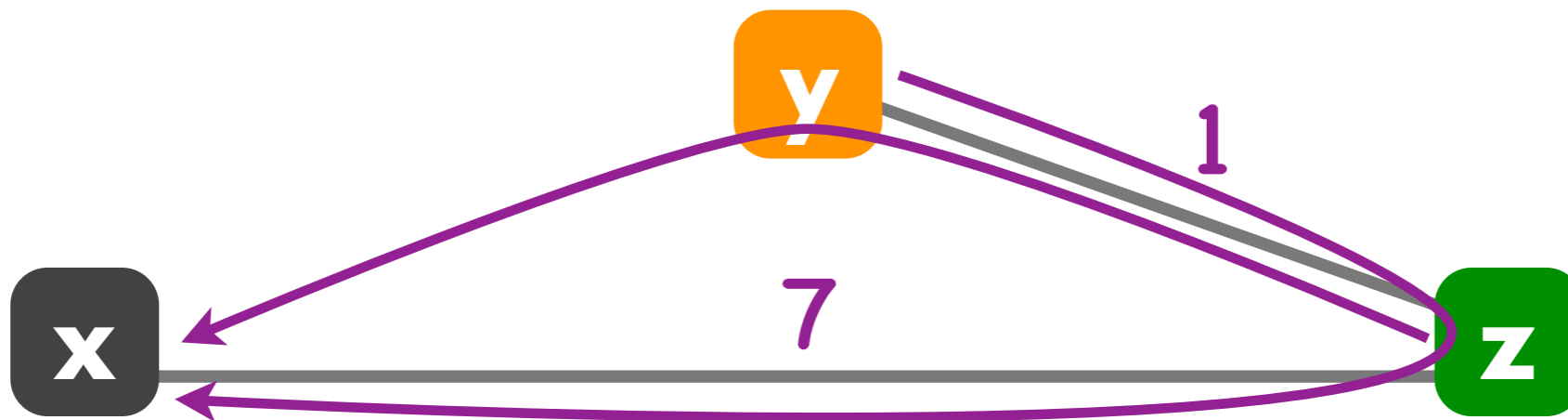

to

		x	y	z
from				
y		4	0	1
z		5	1	0

to

		x	y	z
from	y	4	0	1
z	5	1	0	

routing loop!

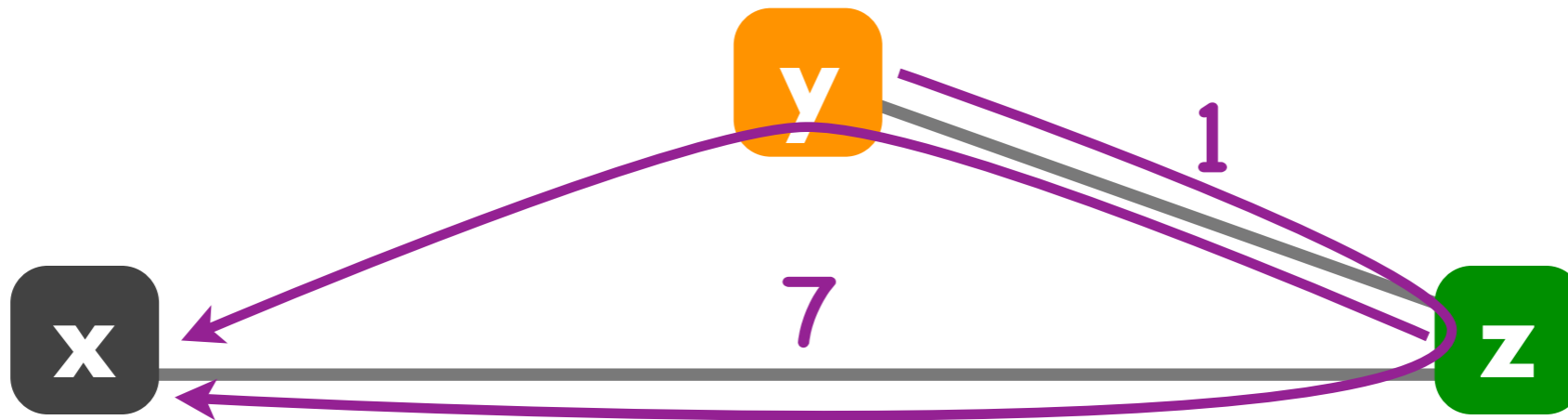

to

		x	y	z
from	y	4	0	1
z	5	1	0	

to

		x	y	z
from	y	6	0	1
z	5	1	0	

routing loop!

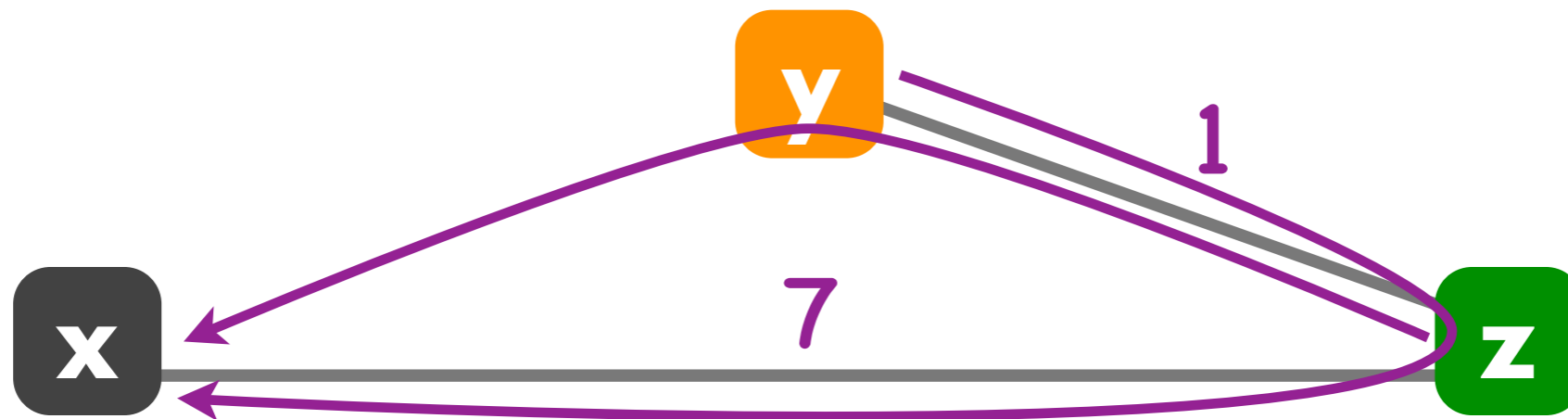

to

		x	y	z
from	y	4	0	1
z	5	1	0	

to

		x	y	z
from				
	y	6	0	1
	z	5	1	0

routing loop!

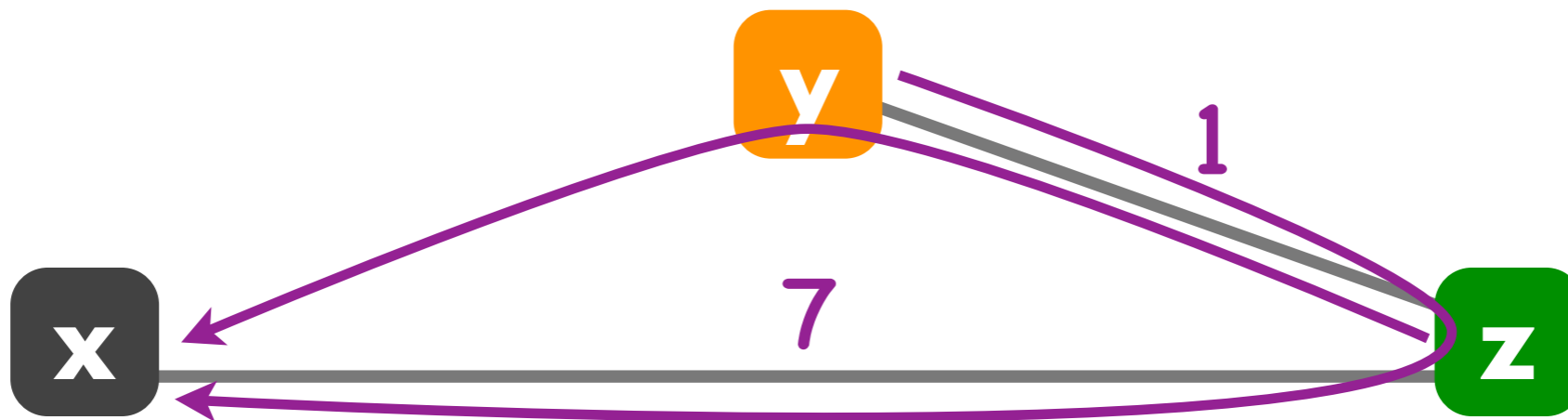

to

		x	y	z
from				
	y	6	0	1
	z	5	1	0

to

		x	y	z
from	y	6	0	1
z	5	1	0	

routing loop!

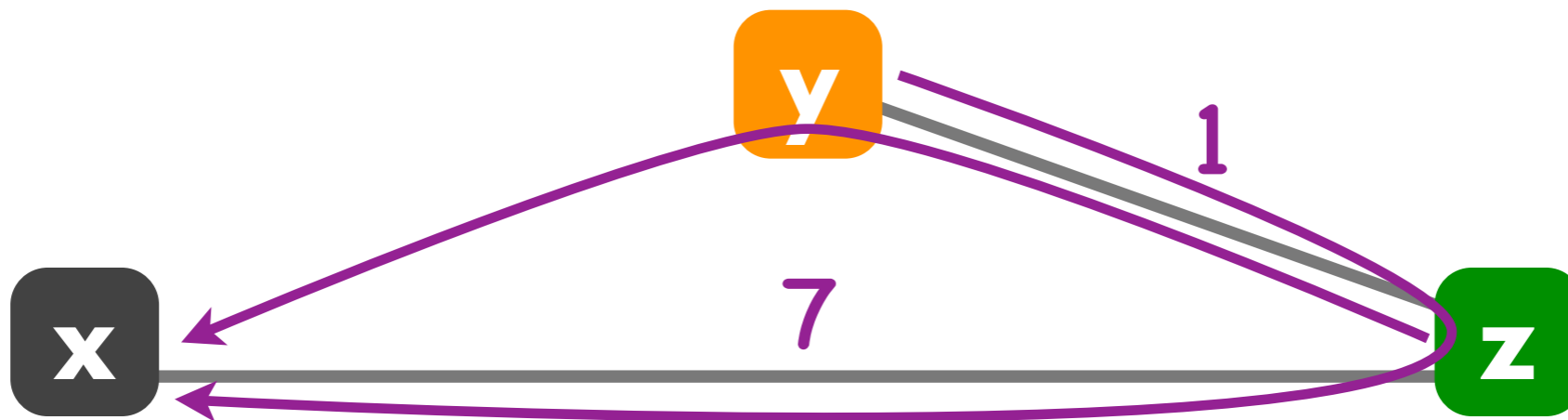

to

		x	y	z
from	y	6	0	1
z	7	1	0	

to

		x	y	z
from	y	6	0	1
z	7	1	0	

routing loop!

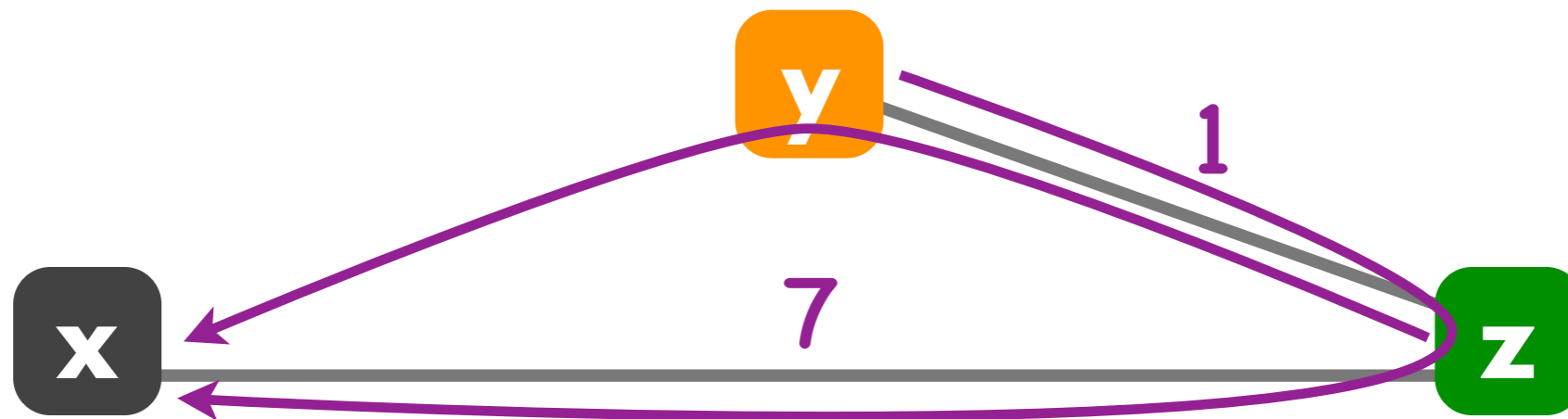

to

		x	y	z
from	y	6	0	1
z	7	1	0	

to

		x	y	z
from	y	8	0	1
z	7	1	0	

routing loop!

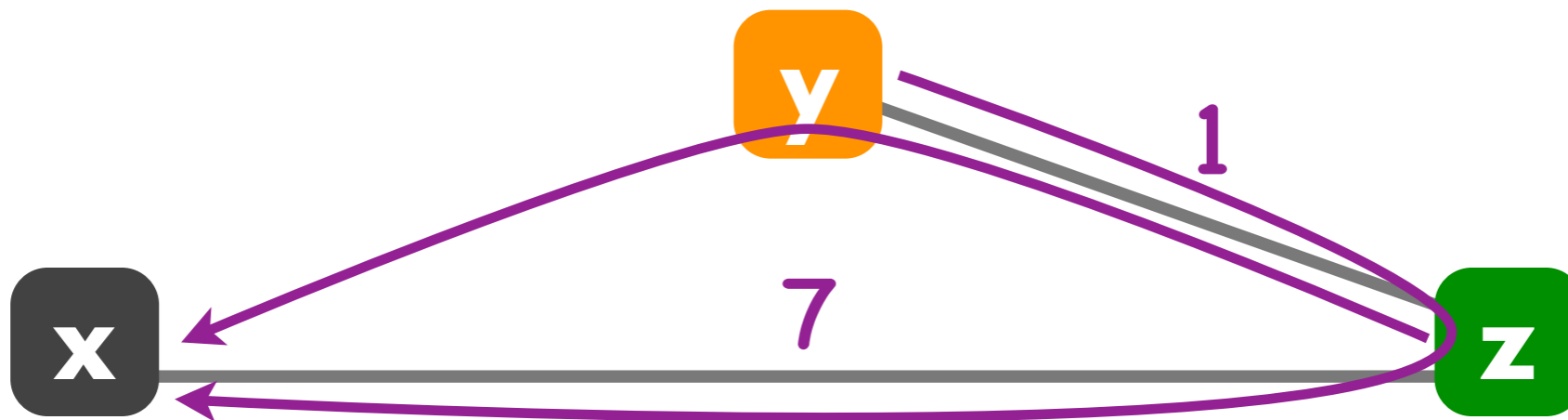

to

		x	y	z
from	y	6	0	1
z	7	1	0	

to

		x	y	z
from				
y		8	0	1
z		7	1	0

routing loop!

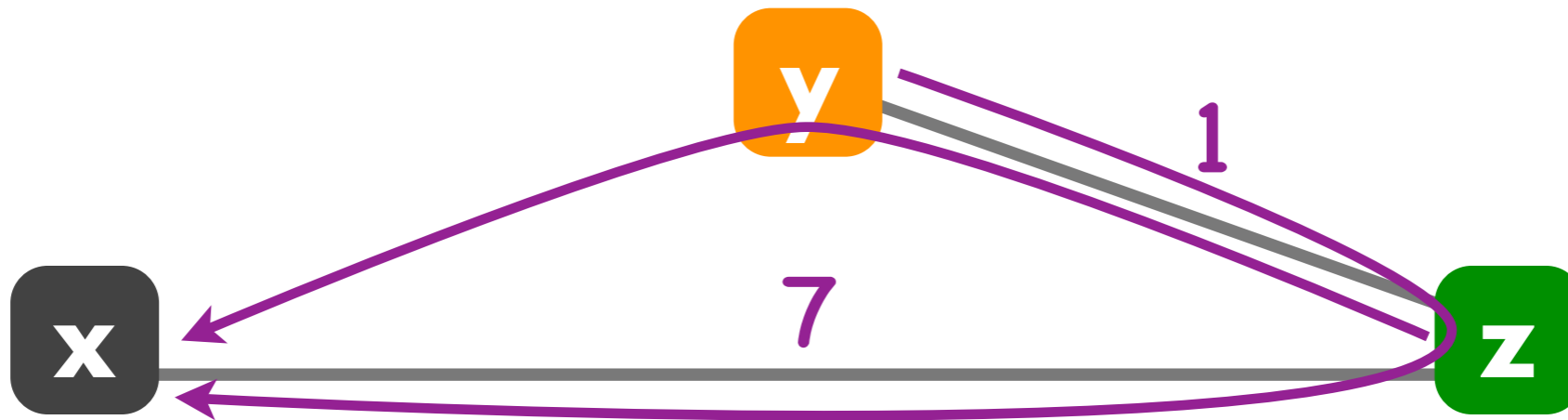

to

		x	y	z
from				
y		8	0	1
z		7	1	0

		to		
		x	y	z
from	y	8	0	1
	z	7	1	0

routing loop!

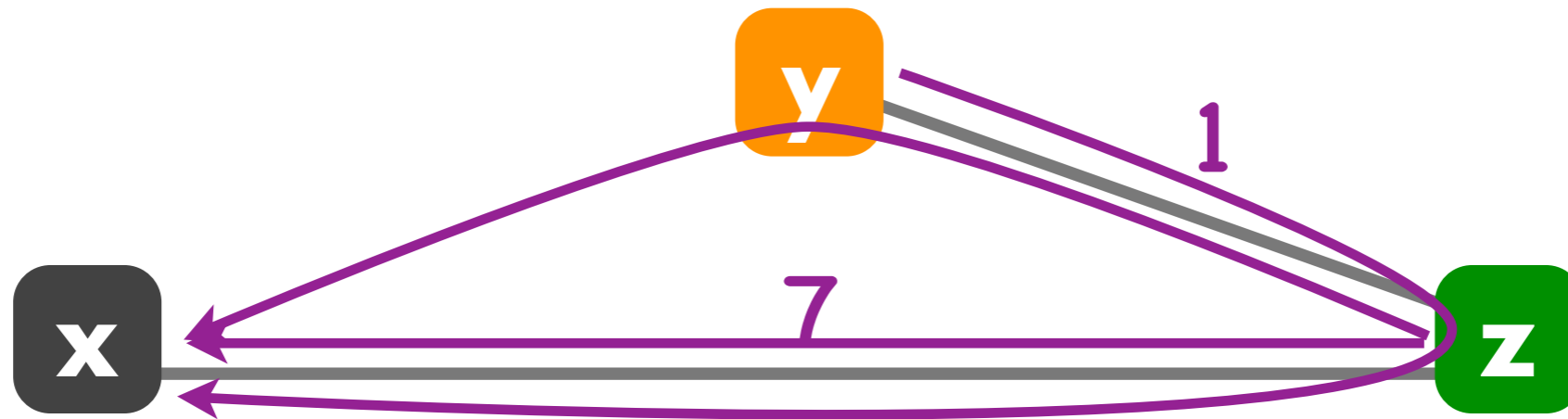

count-to-infinity scenario

		to		
		x	y	z
from	y	8	0	1
	z	7	1	0

Problem with Bellman-Ford

- Routing loop
 - ▶ z routes to x through y
 - ▶ y loses connectivity to x
 - ▶ y decides to route to x through z
- Can take very long to resolve
 - ▶ count-to-infinity scenario

poisoned reverse

to

	x	y	z
y	2	0	1
z	∞	1	0

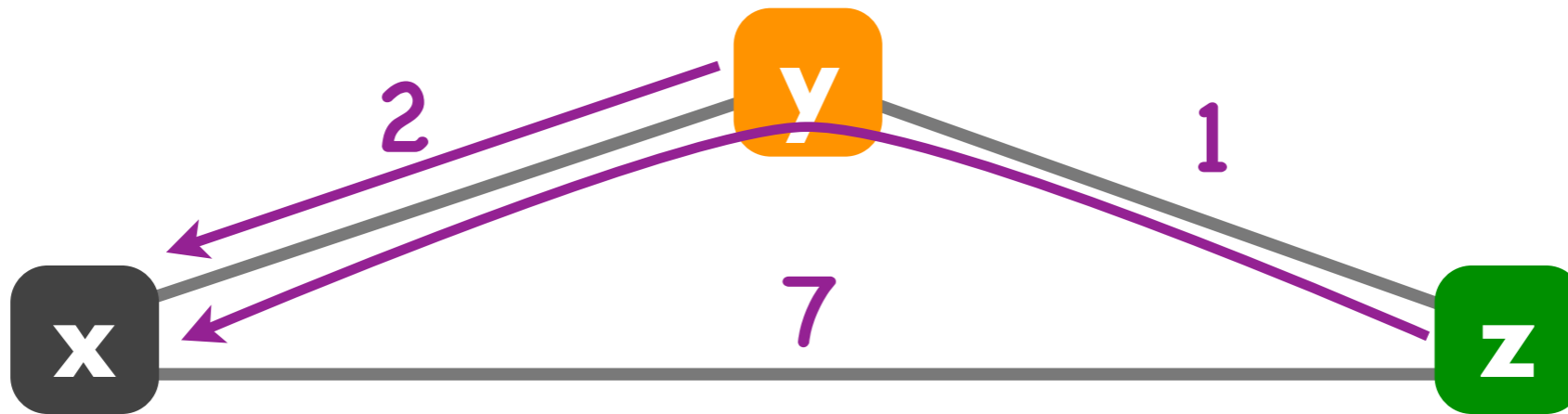

to

	x	y	z
y	2	0	1
z	3	1	0

poisoned reverse

to

	x	y	z
y	∞	0	1
z	∞	1	0

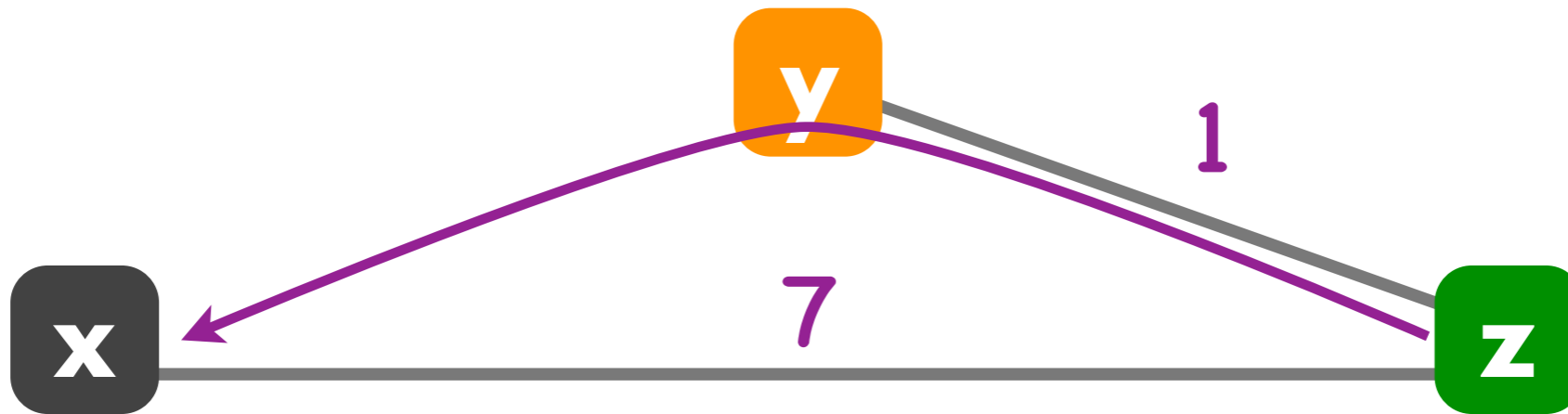

to

	x	y	z
y	2	0	1
z	3	1	0

poisoned reverse

from

	to		
	x	y	z
y	∞	0	1
z	∞	1	0

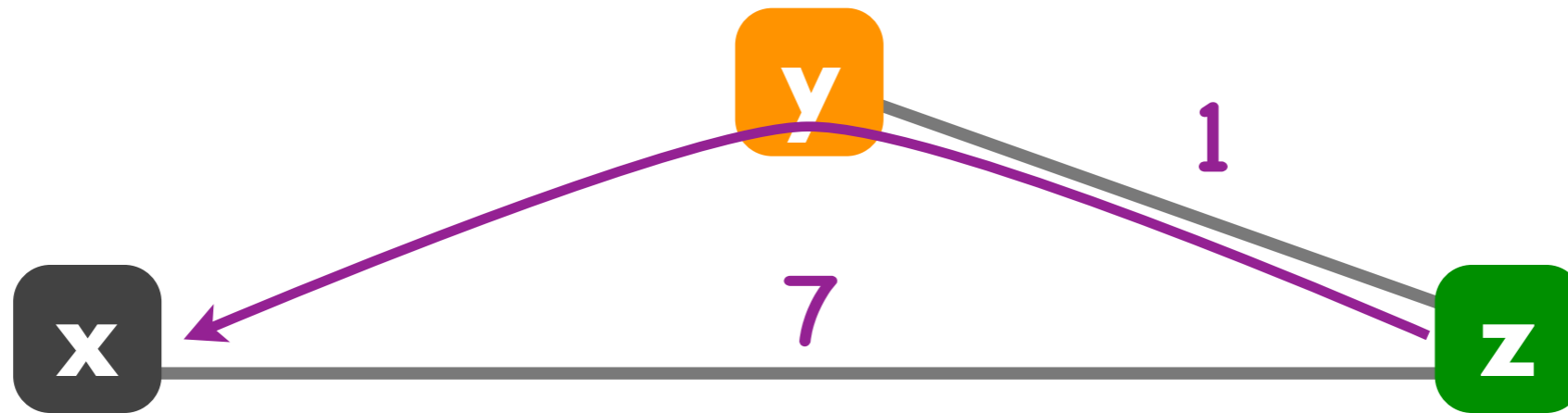

from

	to		
	x	y	z
y	∞	0	1
z	3	1	0

poisoned reverse

to

	x	y	z
from y	∞	0	1
z	∞	1	0

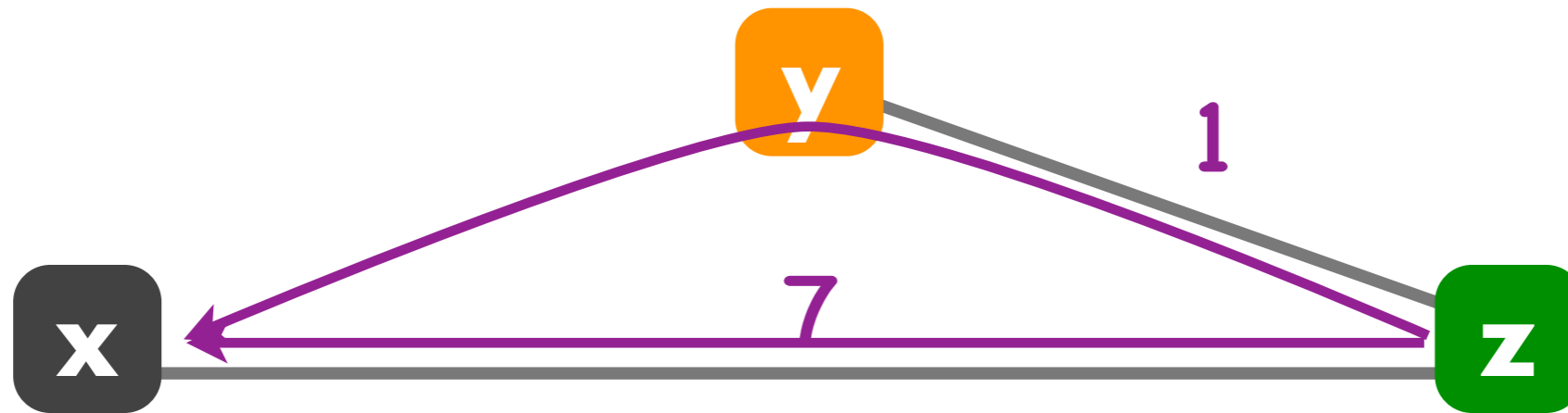

to

	x	y	z
from y	∞	0	1
z	7	1	0

poisoned reverse

to

	x	y	z
y	∞	0	1
z	7	1	0

from

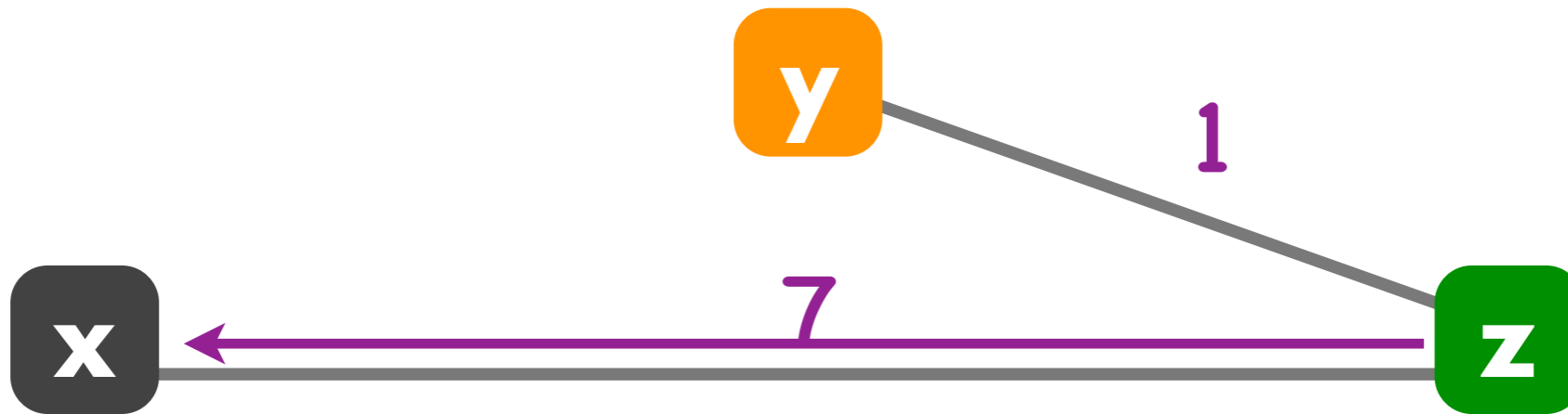

to

	x	y	z
y	∞	0	1
z	7	1	0

from

to

		x	y	z
from	y	8	0	1
z	7	1	0	

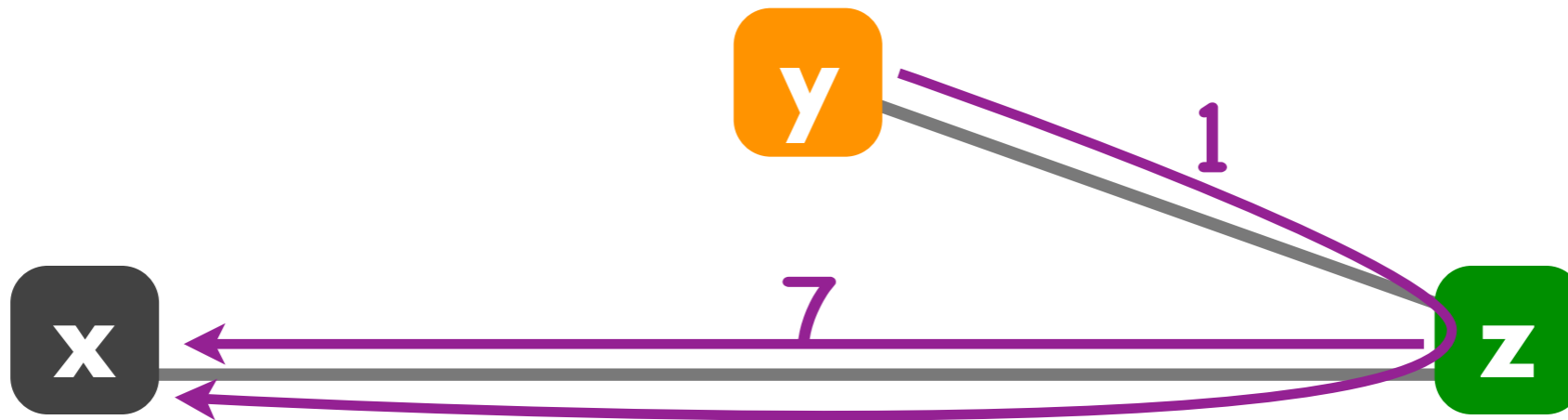

poisoned reverse

to

		x	y	z
from	y	∞	0	1
z	7	1	0	

Solution

- **Poisoned reverse**
 - ▶ if z routes to x through y,
z advertises to y that its cost to x infinite
 - ▶ y never decides to route to x through z
- **Algorithm re-converges quickly**
 - ▶ avoids count-to-infinity scenario

Link-state + distance-vector

- They solve the **same problem**:
compute the least-cost path
from each source router
to each destination router

Link-state vs. distance-vector

- Link state: each entity first obtains **complete view** of the network, then computes the least-cost paths
- Distance vector: each entity obtains **incrementally** new information about the network at every round

Link-state vs. distance-vector

- Link-state converges faster
 - ▶ each router starts with full picture of the network
- Distance-vector uses less bandwidth
 - ▶ each router only talks to its neighbors

dest.	out. link
5.0.0.0/8	3
8.0.0.0/8	1

dest.	out. link
8.0.0.0/8	1
5.0.0.0/8	3

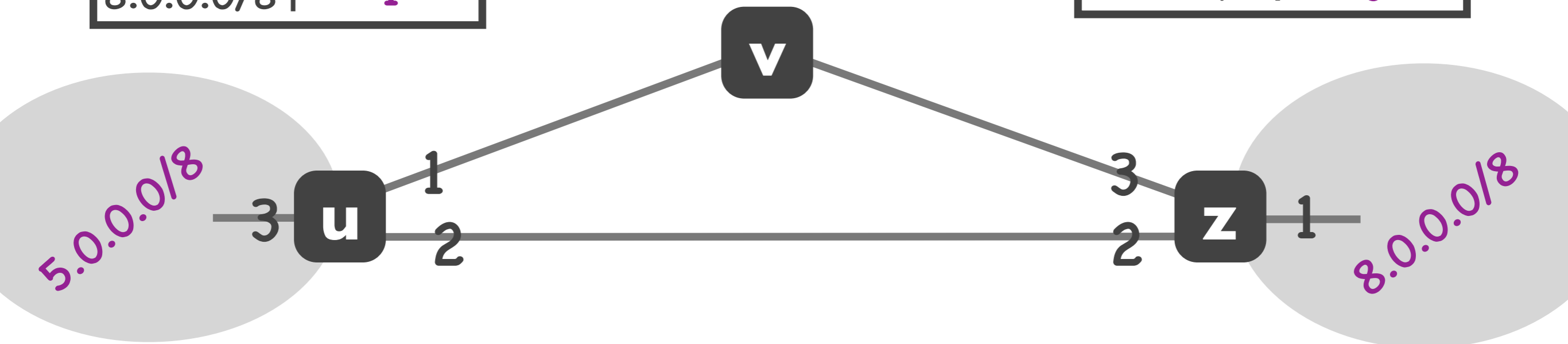

dest.	IP prefixes	next hop
z	8.0.0.0/8	v

dest.	IP prefixes	next hop
u	5.0.0.0/8	v

Internet routing challenges

- **Scale**
 - ▶ link-state would cause flooding
 - ▶ distance-vector would not converge
- **Administrative autonomy**
 - ▶ an ISP may not want to do least-cost routing
 - ▶ may want to hide its link costs from the world

Autonomous Systems

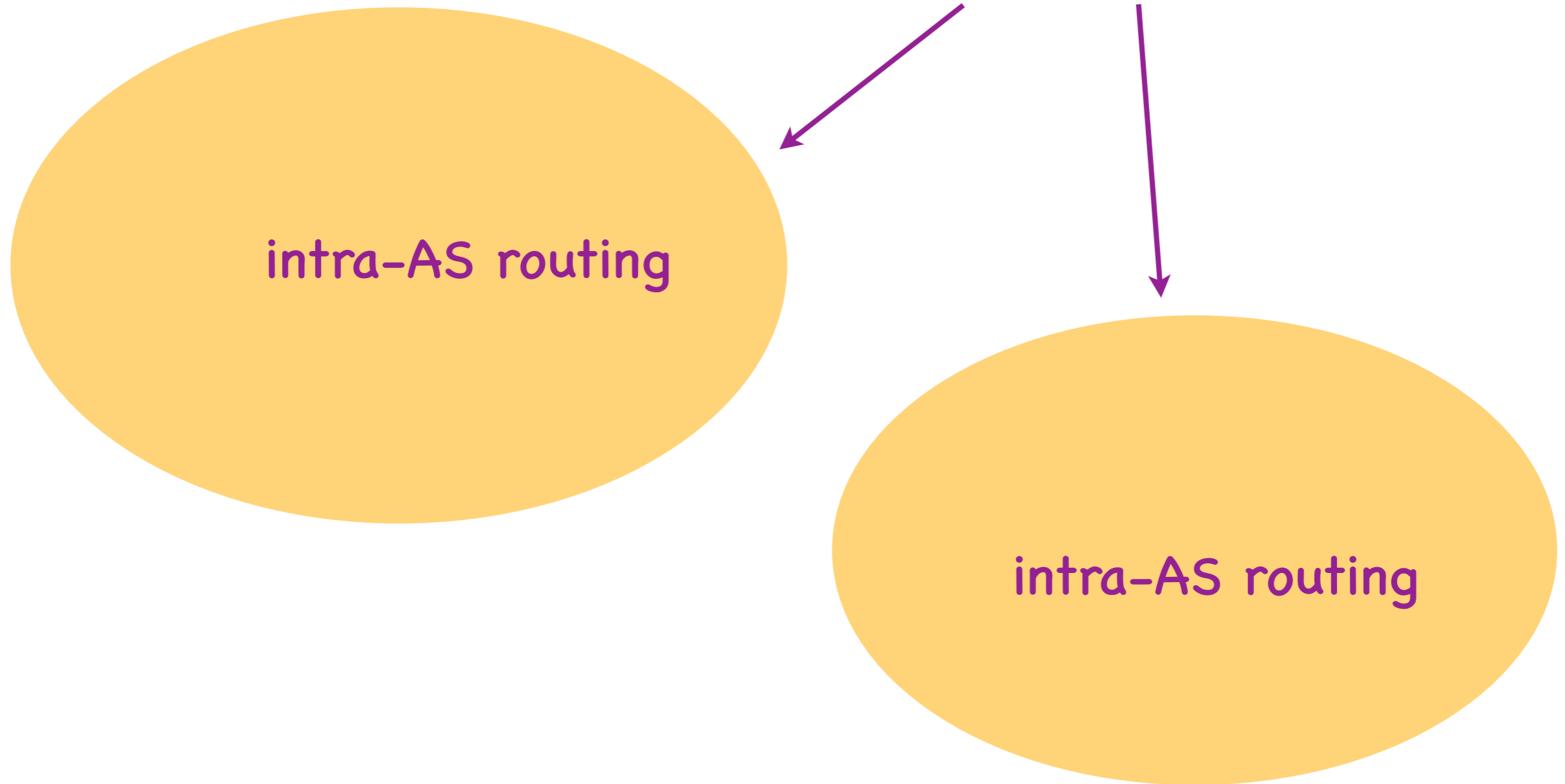

Autonomous Systems

Dijkstra's
algorithm

Bellman-Ford
algorithm

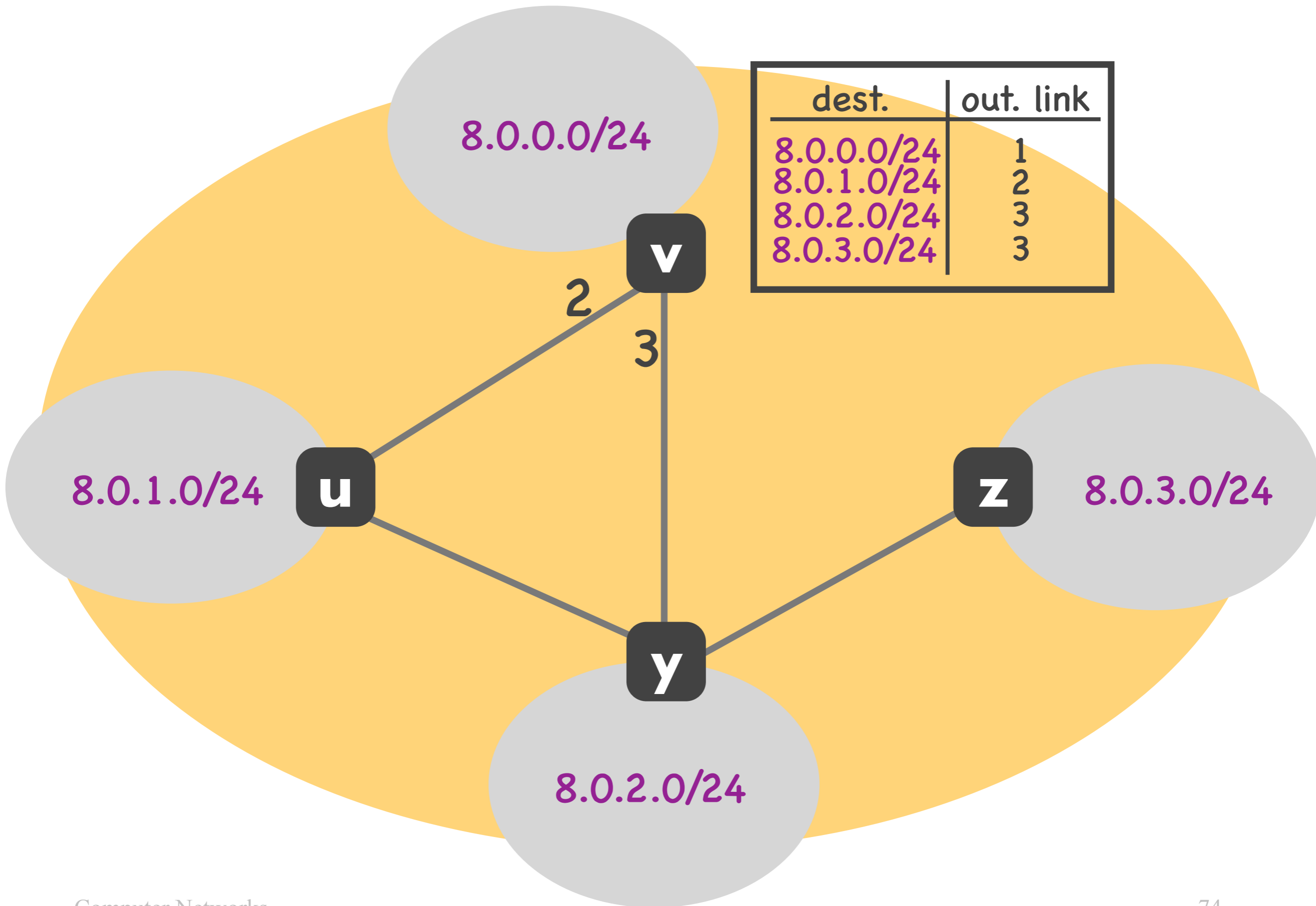

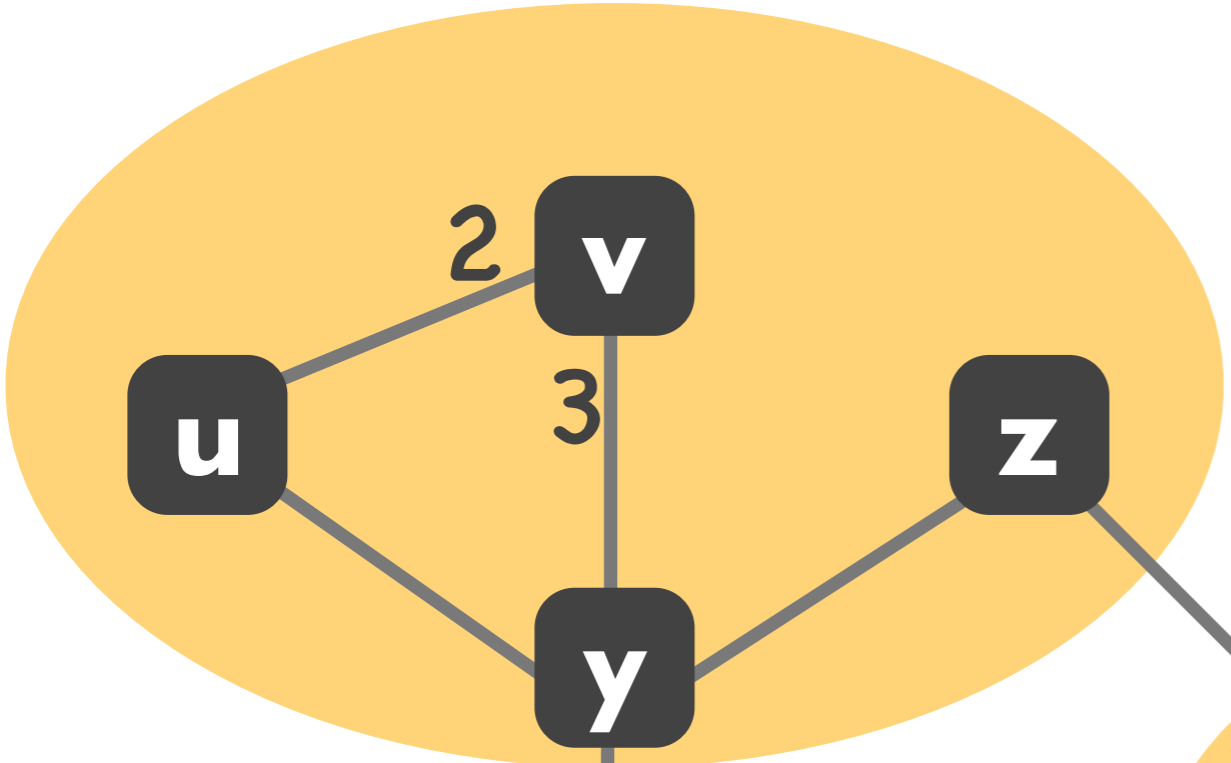

dest.	out. link
8.0.0.0/24	1
8.0.1.0/24	2
8.0.2.0/24	3
8.0.3.0/24	3
5.0.0.0/8	3
6.0.0.0/16	3
7.0.0.0/12	3

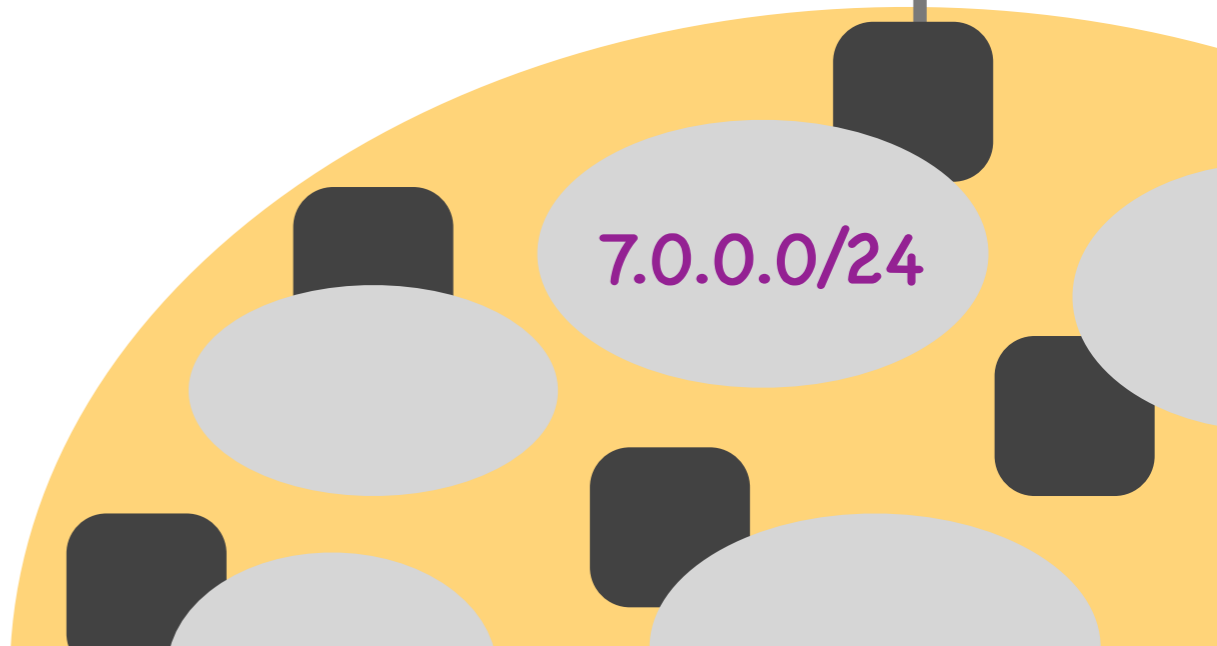
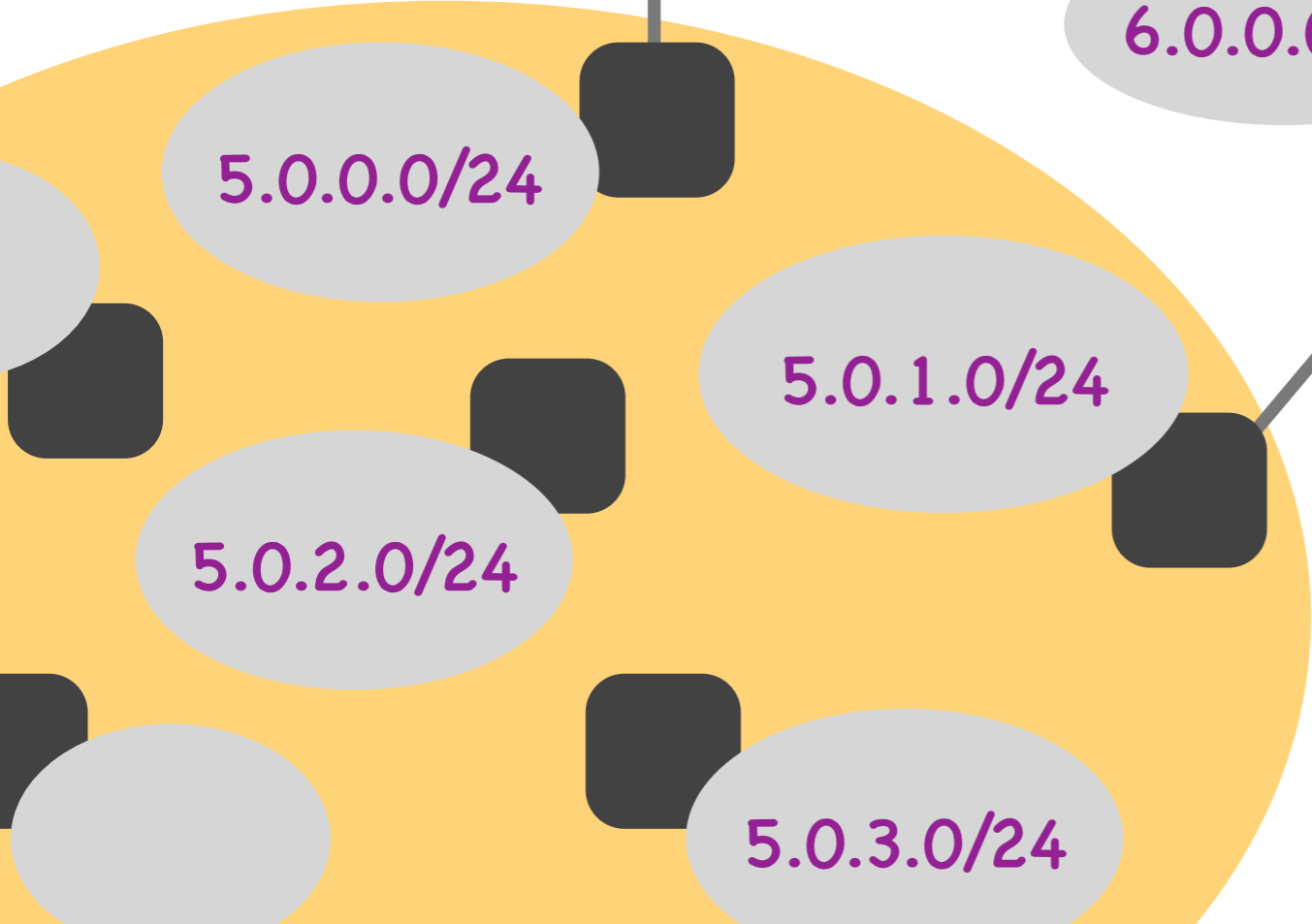
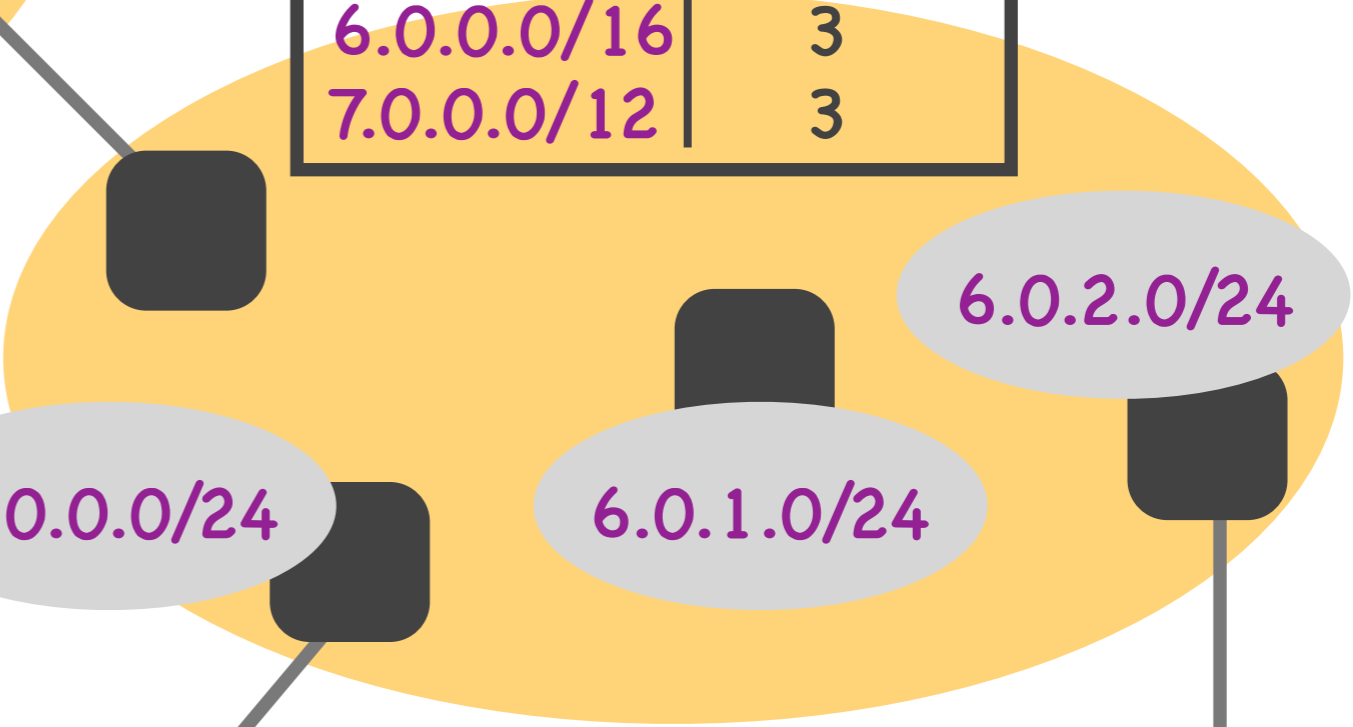

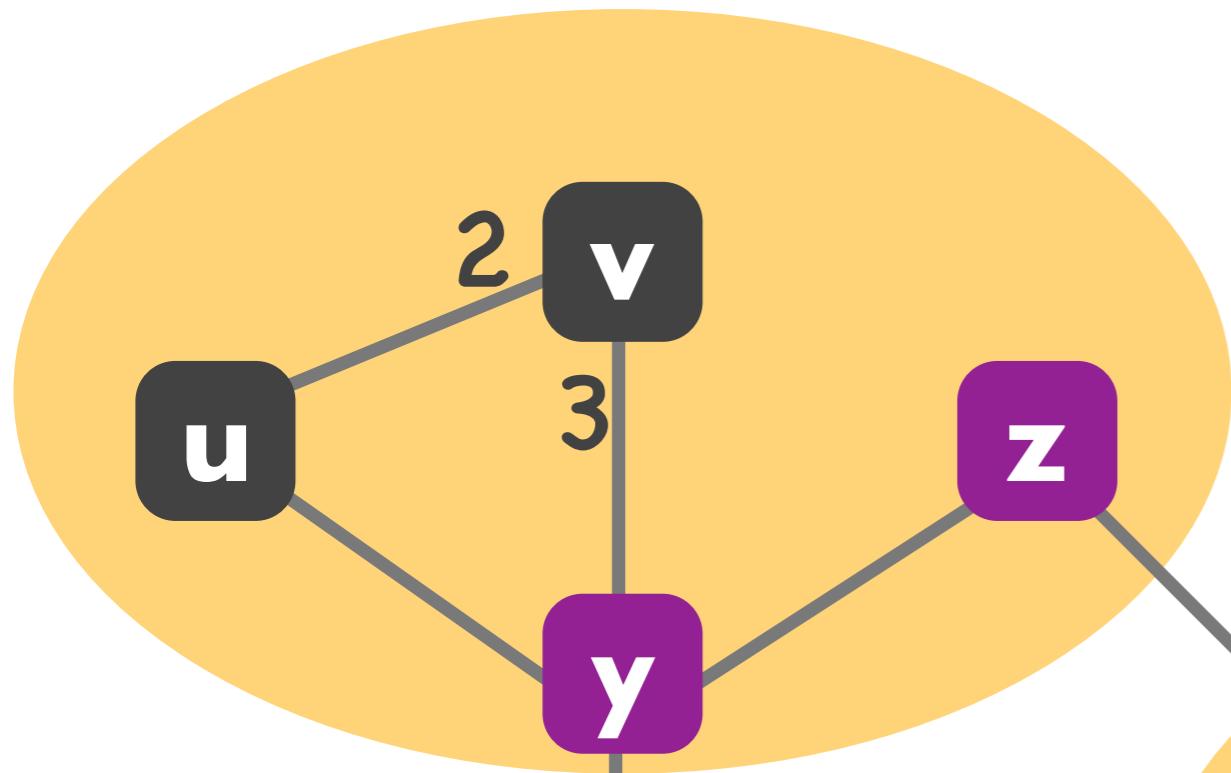

dest.	out. link
8.0.0.0/24	1
8.0.1.0/24	2
8.0.2.0/24	3
8.0.3.0/24	3
5.0.0.0/8	3
6.0.0.0/16	3
7.0.0.0/12	3

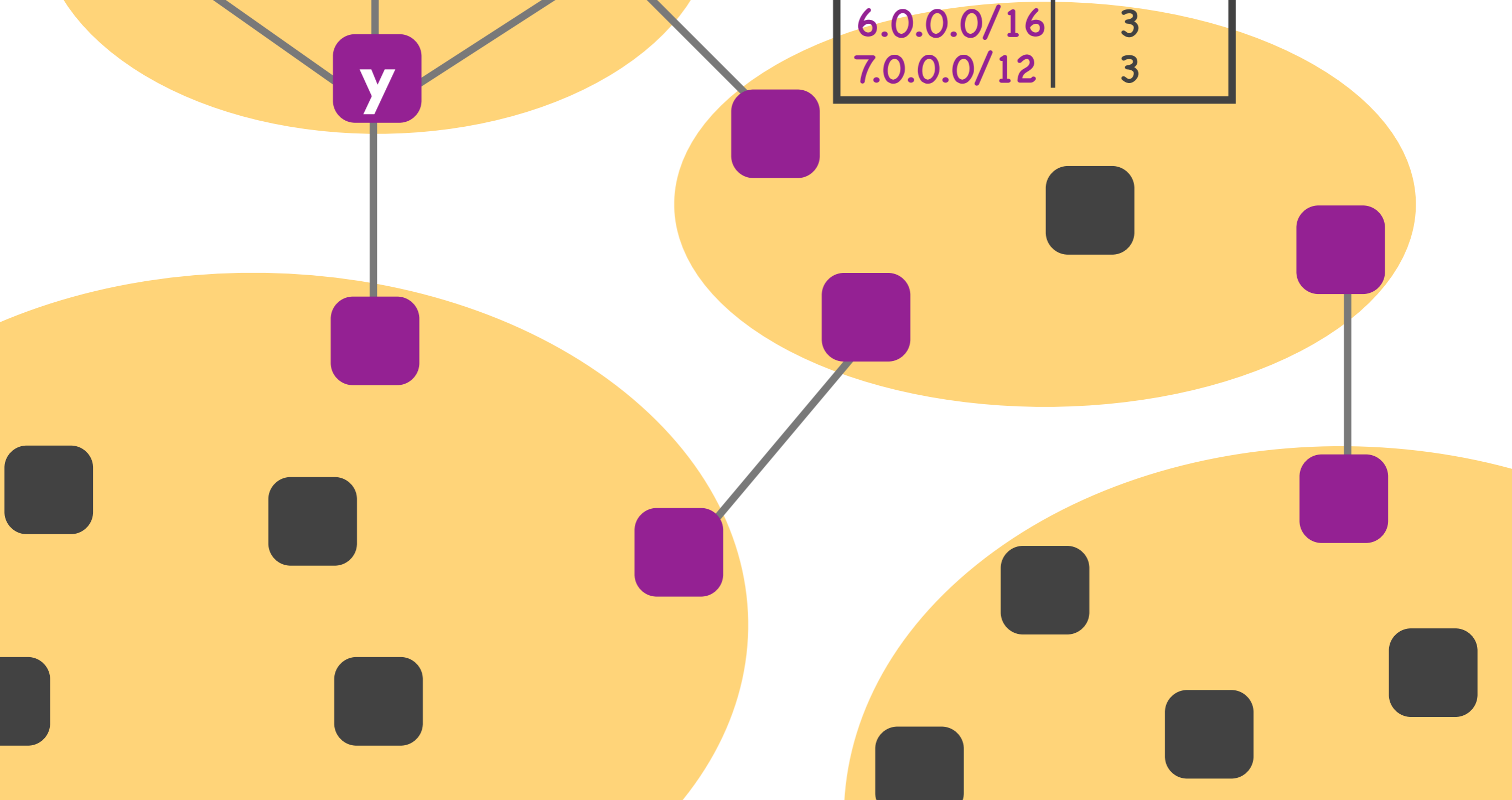

dest.	out. link
8.0.0.0/24	1
8.0.1.0/24	2
8.0.2.0/24	3
8.0.3.0/24	3
5.0.0.0/8	3
6.0.0.0/16	3
7.0.0.0/12	3

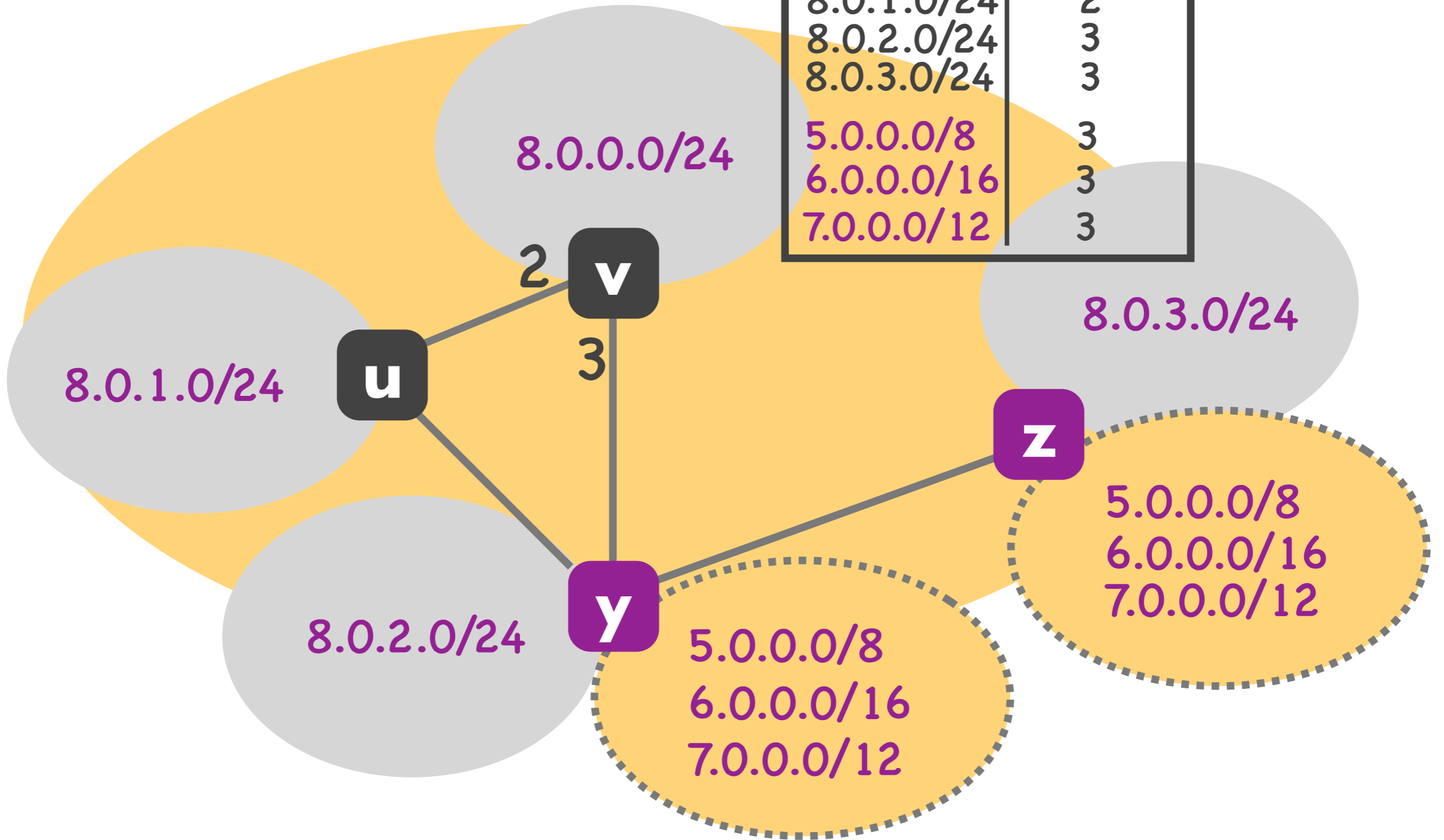

Internet routing

- Each router learns one route to each IP subnet in local AS
- Each router learns one or a few routes to each foreign AS
 - but not one route to each IP subnet of each foreign AS

Intra-AS routing

- Run by **all routers in the same AS**
- Goal: **propagate routes within local AS**
 - ▶ each router advertizes routes to its local IP subnets
 - ▶ and potentially routes to other ASes that it has learned through BGP
- OSPF, RIP, ...

Inter-AS routing

- Run by **all border routers** between ASes
- Goal: **propagate routes outside** local AS
 - ▶ each border router talks to external neighbors (eBGP)
 - ▶ and to the other border routers of the local AS (iBGP)
- **BGP** = Border Gateway Protocol

Internet routing challenges

- **Scale**
 - ▶ link-state would cause flooding
 - ▶ distance-vector would not converge
- **Administrative autonomy**
 - ▶ an ISP may not want to do least-cost routing
 - ▶ may want to hide its link costs from the world

Solution: hierarchy

- Scale: state **not** per IP subnet
 - ▶ each router needs forwarding entries per **local** IP subnets and foreign **IP prefixes**
 - ▶ each router may communicate with all other **local** routers and external **neighbors**
- Administrative autonomy:
each AS chooses its own intra-AS routing protocol